

Encuentro con techo - Opción **A** en capa fina sobre soporte plano (ej. Hormigón)

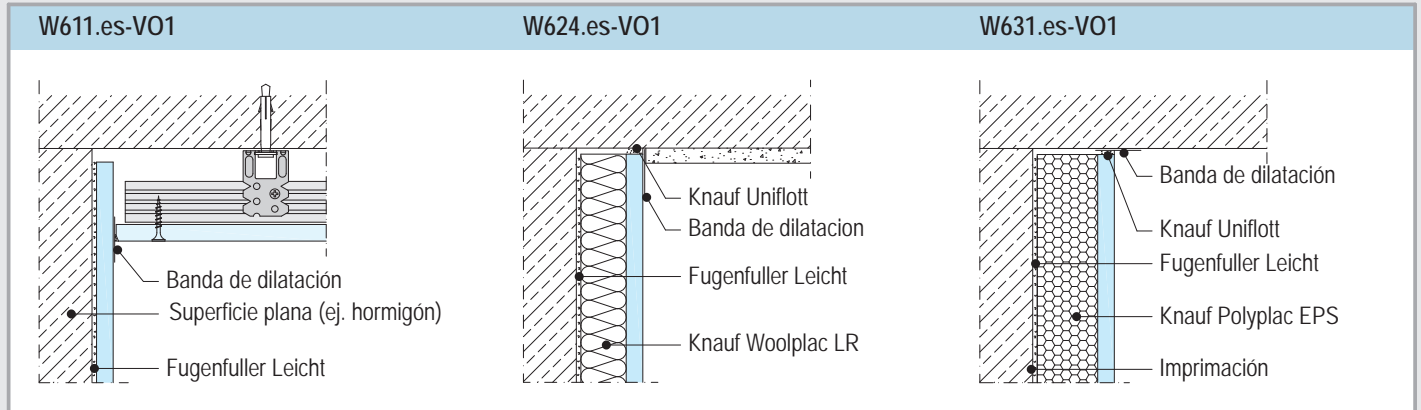

Zona central - Opción **B** con pelladas de Perfix sobre soporte irregular hasta 20 mm. (ej. Ladrillo)

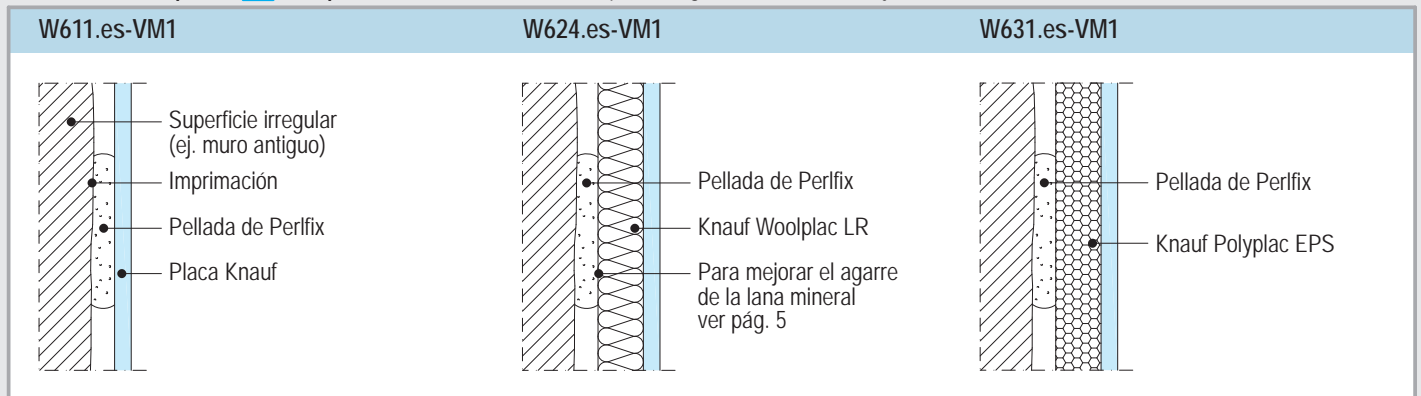

Encuentro con solera - Opción **C** con tientos sobre soporte muy irregular > 20 mm. (ej. Rehabilitaciones)

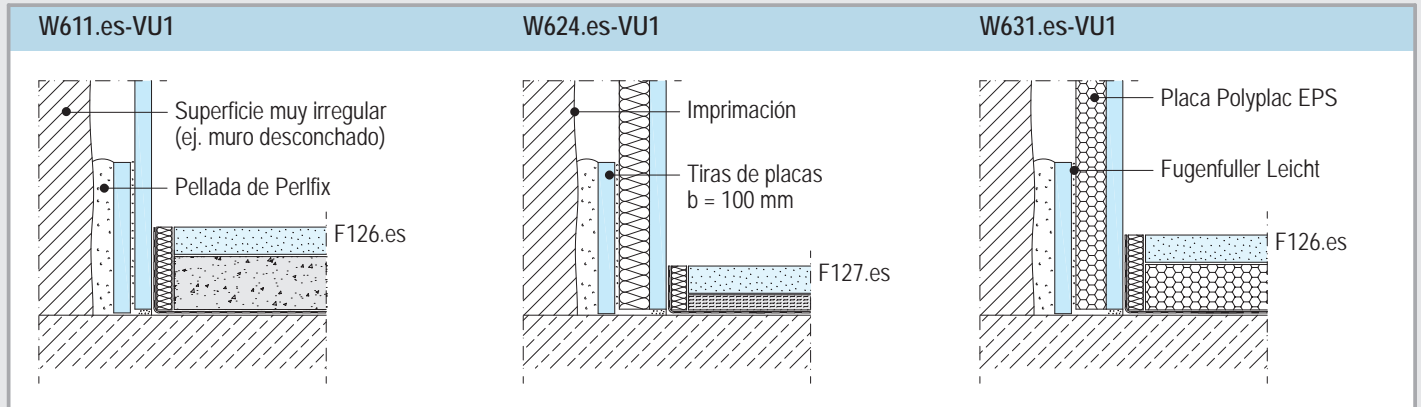

Detalles E. 1:5

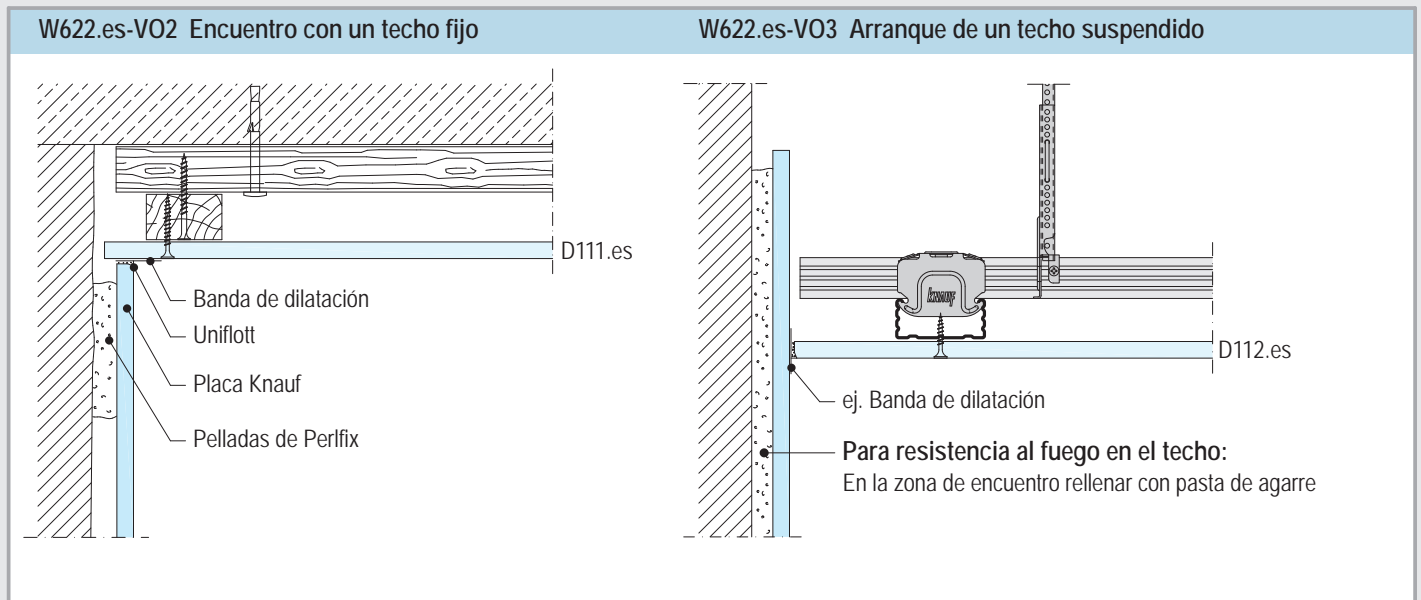

W631.es-H1 Encuentro con un muro

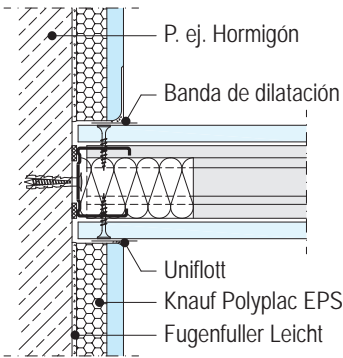

W624.es-H1 Encuentro con un muro

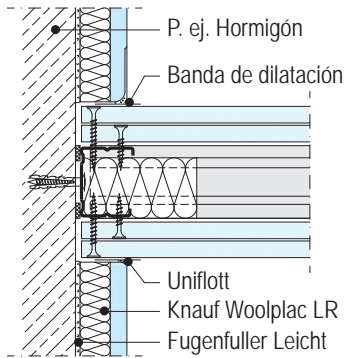

W624.es-H2 Encuentro con un tabique

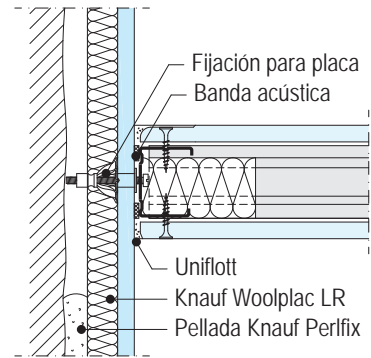

W631.es-H2 Esquina

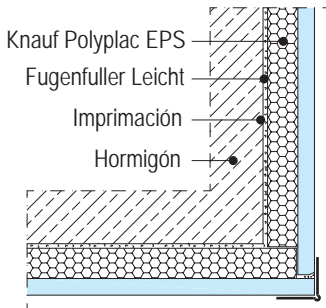

W624.es-H3 Rincón

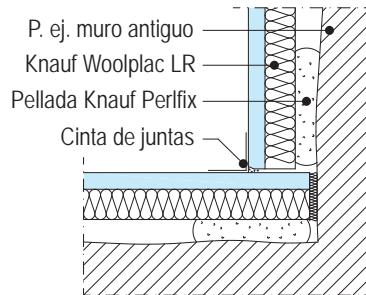

W611.es-H2 Esquina 135°

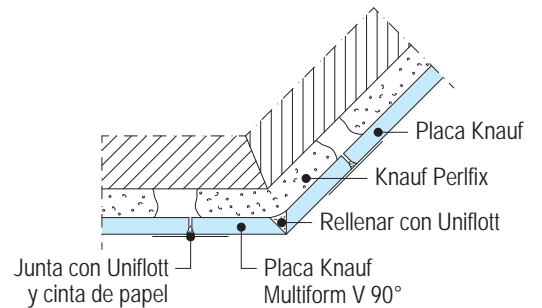

W611.es-H6 Encuentro ventana

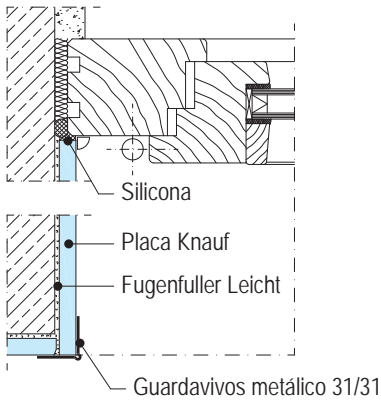

W624.es-H5 Encuentro ventana

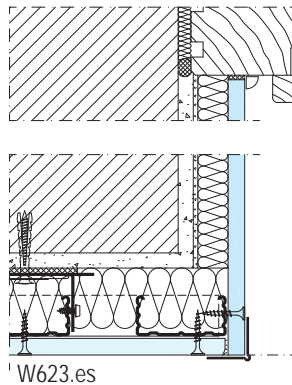

W624.es-H6 Encuentro ventana

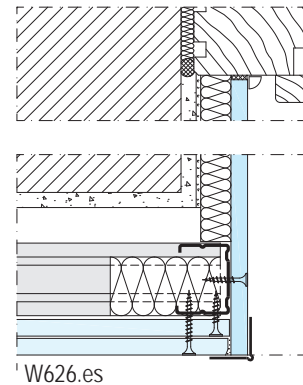

W611.es-H4 Puerta tipo monoblock

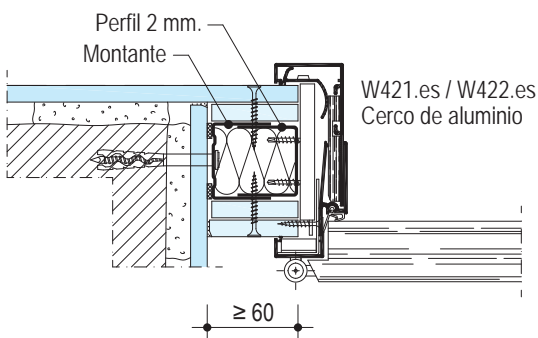

W611.es-H3 Junta de dilatación con perfil aluminio

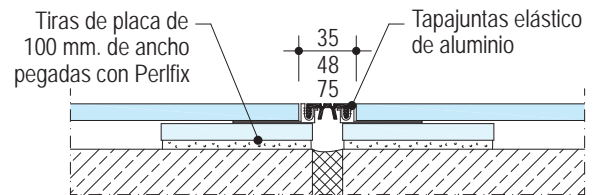

W611.es-H7 Junta de dilatación

