



CARACTERÍSTICAS

- Funcionamiento por deformación.
- Homologación europea para aplicaciones estructurales en hormigón no fisurado.
- Homologación europea para aplicaciones no estructurales en hormigón fisurado y no fisurado. También en losas alveolares (solo HE-HC)
- Instalación previa al material a fijar.
- El perno puede ser desmontado, dejando la superficie del material base diáfana.
- Perno no suministrado.
- VdS disponible desde M8 hasta M20 (HEHO, HECL, HEA4, HEHC).
- FM disponible desde M10 hasta M16 (HEHO, HECL).
- Disponible en INDEXcal.

APLICACIONES

- Fijaciones de techos suspendidos, sistemas de rociadores y ventilación.
- Fijaciones estructurales, herrajes en interiores y/o exteriores.
- Fijaciones de varillas roscadas
- Fijaciones en losas alveolares (solo HE-HC)

MEDIDAS

M6 - M20

HOMOLOGACIONES



CARGAS RECOMENDADAS A TRACCIÓN EN HORMIGÓN NO FISURADO [kg]

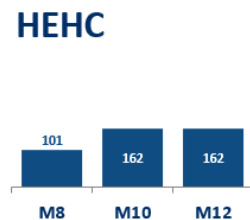
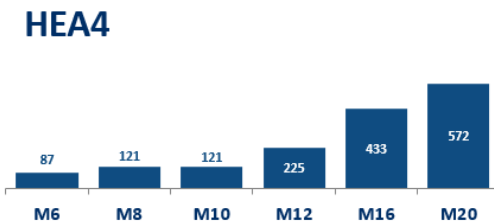
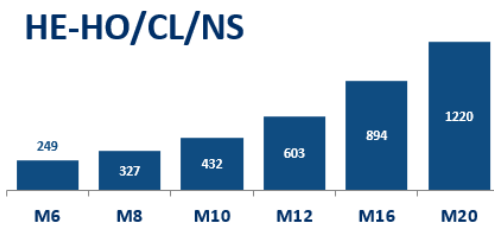

CONDICION DE TALADRO

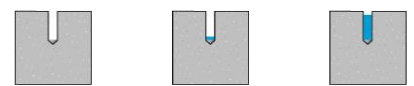

SECO HUMEDO INUNDADO

MATERIAL BASE



EJEMPLOS DE APLICACIÓN

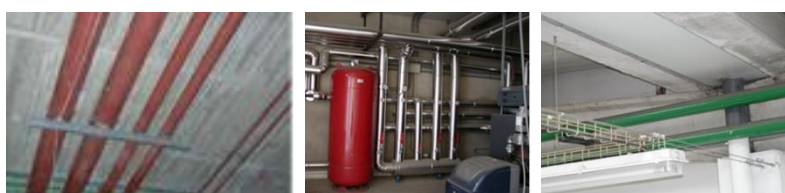

1. GAMA						
ITEM	CÓDIGO	MEDIDA	FOTO	COMPONENTE	MATERIAL	RECUBRIMIENTO
1	HE-HO	M6 a M20		Camisa Cono	Acero al carbono Acero al carbono Cincado $\geq 5 \mu\text{m}$	
2	HE-CL	M6 a M16		Camisa Cono	Acero al carbono Acero al carbono Cincado $\geq 5 \mu\text{m}$	
3	HEA4	M6 a M20		Camisa Cono	Acero inoxidable A4 Acero inoxidable A4	
4	HE-NO	M6 a M20		Camisa Cono	Acero al carbono Acero al carbono Cincado $\geq 5 \mu\text{m}$	
5	HE-NS	M6 a M20		Camisa Cono	Acero al carbono Acero al carbono Sherardizado $\geq 40 \mu\text{m}$	
6	HE-HC	M8 a M12		Camisa Cono	Acero al carbono Acero al carbono Cincado $\geq 5 \mu\text{m}$	

2. ACCESORIOS				
ITEM	CÓDIGO	FOTO	DESCRIPCION	VALIDO PARA
1	EXP		Expansionador con mango de goma para métricas M6-M16	HE-HO HE-CL HEA4 HE-NO HE-NS
2	EXP		Expansionador sin mango para métricas M20	HE-HO HEA4 HE-NO
3	EXP-C		Expansionador con mango de goma para métricas M8-M12	HE-HC

3.DATOS DE INSTALACION EN HORMIGON

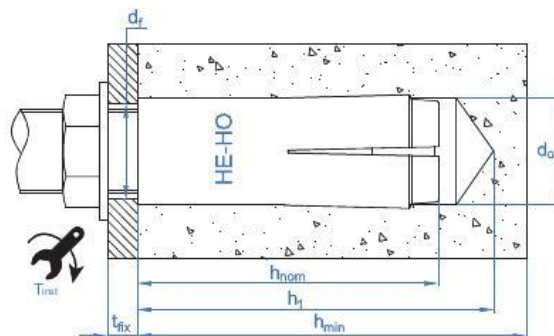

3.1 APLICACIONES ESTRUCTURALES

Familia	Código	Medida	Homologación	Diámetro de broca		Par de instalación	Distancia mínima entre anclajes	Distancia mínima al borde	Espesor mínimo de hormigón	profundidad del taladro	profundidad de instalación	longitud del perno *	distancia crítica entre anclajes	distancia crítica al borde	Útil de instalación
				d ₀	d _f										
[--]	[--]	[--]	ETA	[--]	[--]	T _{ins}	S _{min}	C _{min}	h _{min}	h ₁	h _{nom}	e	S _{cr,N}	C _{cr,N}	[--]
HE-HO	HEHOM06	M6 x 25 Ø8	✓	8	7	4	60	105	100	27	25	6 – 10	75	38	EXHBM06
	HEHOM08	M8 x 30 Ø10	✓	10	9	11	60	105	100	33	30	8 – 13	90	45	EXHBM08
	HEHOM10	M10 x 40 Ø12	✓	12	12	17	80	140	100	43	40	10 – 17	120	60	EXHBM10
	HEHOM12	M12 x 50 Ø15	✓	15	14	38	100	175	100	54	50	12 – 21	150	75	EXHBM12
	HEHOM16	M16 x 65 Ø20	✓	20	18	60	130	230	130	70	65	16 – 27	195	98	EXHBM16
	HEHOM20	M20 x 80 Ø25	✓	25	22	100	160	280	160	86	80	20 – 34	240	120	EXHBM20
HEHOM12D	M12 x 50 Ø16	--	16	12	38	100	175	100	50	50	12 – 21	150	75	EXHBM12	
HE-NO	HENOM06	M6 x 25 Ø8	--	8	7	4	60	105	100	27	25	6 – 10	75	38	EXHBM06
	HENOM08	M8 x 30 Ø10	--	10	9	11	60	105	100	33	30	8 – 13	90	45	EXHBM08
	HENOM10	M10 x 40 Ø12	--	12	12	17	80	140	100	43	40	10 – 17	120	60	EXHBM10
	HENOM12	M12 x 50 Ø15	--	15	14	38	100	175	100	54	50	12 – 21	150	75	EXHBM12
	HENOM16	M16 x 65 Ø20	--	20	18	60	130	230	130	70	65	16 – 27	195	98	EXHBM16
	HENOM20	M20 x 80 Ø25	--	25	22	100	160	280	160	86	80	20 – 34	240	120	EXHBM20
HE-CL	HECLOM06	M6 x 25 Ø8	✓	8	7	4	60	105	100	27	25	6 – 10	75	38	EXHBM06
	HECLOM08	M8 x 30 Ø10	✓	10	9	11	60	105	100	33	30	8 – 13	90	45	EXHBM08
	HECLOM10	M10 x 40 Ø12	✓	12	12	17	80	140	100	43	40	10 – 17	120	60	EXHBM10
	HECLOM12	M12 x 50 Ø15	✓	15	14	38	100	175	100	54	50	12 – 21	150	75	EXHBM12
	HECLOM16	M16 x 65 Ø20	✓	20	18	60	130	230	130	70	65	16 – 27	195	98	EXHBM16
	HECLOM12D	M12 x 50 Ø16	--	16	12	38	100	175	100	54	50	12 – 21	150	75	EXHBM12
HE-A4	HEA4M06	M6 x 25 Ø8	--	8	7	4	60	105	100	27	25	6 – 10	75	38	EXHBM06
	HEA4M08	M8 x 30 Ø10	--	10	9	11	60	105	100	33	30	8 – 13	90	45	EXHBM08
	HEA4M10	M10 x 40 Ø12	--	12	12	17	80	140	100	43	40	10 – 17	120	60	EXHBM10
	HEA4M12	M12 x 50 Ø15	--	15	14	38	100	175	100	54	50	12 – 21	150	75	EXHBM12
	HEA4M16	M16 x 65 Ø20	--	20	18	60	130	230	130	70	65	16 – 27	195	98	EXHBM16
	HEA4M20	M20 x 80 Ø25	--	25	22	100	160	280	160	86	80	20 – 34	240	120	EXHBM20
HE-NS	HENSM06	M6 x 25 Ø8	--	8	7	4	60	105	100	27	25	6 – 10	75	38	EXHBM06
	HENSM08	M8 x 30 Ø10	--	10	9	11	60	105	100	33	30	8 – 13	90	45	EXHBM08
	HENSM10	M10 x 40 Ø12	--	12	12	17	80	140	100	43	40	10 – 17	120	60	EXHBM10
	HENSM12	M12 x 50 Ø15	--	15	14	38	100	175	100	54	50	12 – 21	150	75	EXHBM12
	HENSM16	M16 x 65 Ø20	--	20	18	60	130	230	130	70	65	16 – 27	195	98	EXHBM16

(*) Longitud del perno a instalar (no suministrado) = e + espesor arandela + espesor material a fijar.

3.2 APLICACIONES NO ESTRUCTURALES

Familia	Código	Medida	Homologación	Diámetro de broca	Diámetro en placa anclaje \leq	Par de instalación	Distancia mínima entre anclajes	Distancia mínima al borde	Espesor mínimo de hormigón	profundidad del taladro	profundidad de instalación	longitud del perno*	distancia crítica entre anclajes	distancia crítica al borde	Útil de instalación
[--]	[--]	[--]	ETA	[--]	[--]	[--]	[--]	[--]	[--]	[--]	[--]	[--]	[--]	[--]	[--]
HE-HO	HEHOM06	M6 x 25 Ø8	✓	8	7	4	60	105	100	27	25	6 – 10	75	38	EXHBM06
	HEHOM08	M8 x 30 Ø10	✓	10	9	11	60	105	100	33	30	8 – 13	90	45	EXHBM08
	HEHOM10	M10 x 40 Ø12	✓	12	12	17	80	140	100	43	40	10 – 17	120	60	EXHBM10
	HEHOM12	M12 x 50 Ø15	✓	15	14	38	100	175	100	54	50	12 – 21	150	75	EXHBM12
	HEHOM16	M16 x 65 Ø20	✓	20	18	60	130	230	130	70	65	16 – 27	195	98	EXHBM16
	HEHOM20	M20 x 80 Ø25	✓	25	22	100	160	280	160	86	80	20 – 34	240	120	EXHBM20
	HEHOM12D	M12 x 50 Ø16	✓	16	12	38	100	175	100	50	50	12 – 21	150	75	EXHBM12
HE-CL	HECLOM06	M6 x 25 Ø8	✓	8	7	4	60	105	100	27	25	6 – 10	75	38	EXHBM06
	HECLOM08	M8 x 30 Ø10	✓	10	9	11	60	105	100	33	30	8 – 13	90	45	EXHBM08
	HECLOM10	M10 x 40 Ø12	✓	12	12	17	80	140	100	43	40	10 – 17	120	60	EXHBM10
	HECLOM12	M12 x 50 Ø15	✓	15	14	38	100	175	100	54	50	12 – 21	150	75	EXHBM12
	HECLOM16	M16 x 65 Ø20	✓	20	18	60	130	230	130	70	65	16 – 27	195	98	EXHBM16
	HECLOM12D	M12 x 50 Ø16	✓	16	12	38	100	175	100	54	50	12 – 21	150	75	EXHBM12
HE-A4	HEA4M06	M6 x 25 Ø8	✓	8	7	4	60	105	100	27	25	6 – 10	200	150	EXHBM06
	HEA4M08	M8 x 30 Ø10	✓	10	9	11	60	105	100	33	30	8 – 13	200	150	EXHBM08
	HEA4M10	M10 x 40 Ø12	✓	12	12	17	80	140	100	43	40	10 – 17	200	150	EXHBM10
	HEA4M12	M12 x 50 Ø15	✓	15	14	38	100	175	100	54	50	12 – 21	200	150	EXHBM12
	HEA4M16	M16 x 65 Ø20	✓	20	18	60	130	230	130	70	65	16 – 27	260	195	EXHBM16
	HEA4M20	M20 x 80 Ø25	✓	25	22	100	160	280	160	86	80	20 – 34	320	240	EXHBM20
HE-HC	HEHCM08	M8 x 25 Ø10	✓	10	9	11	75	60	80	28	25	8 – 13	120	60	EXHBM08C
	HEHCM10	M10 x 25 Ø12	✓	12	12	17	75	60	80	28	25	10 – 17	120	60	EXHBM10C
	HEHCM12	M12 x 25 Ø15	✓	15	14	38	75	60	80	29	25	12 – 21	120	60	EXHBM12C

(*) Longitud del perno a instalar (no suministrado) = e + espesor arandela + espesor material a fijar.

4.DATOS DE INSTALACION EN LOSAS ALVEOLARES

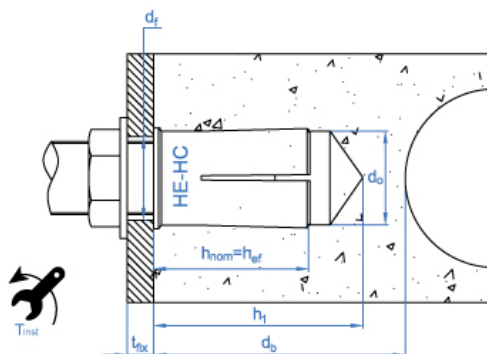

4.1 APLICACIONES NO ESTRUCTURALES

Familia	Código	Medida	Homologación	Diámetro de broca	Diámetro en placa anclaje s_e	Par de instalación	Distancia mínima entre anclajes	Distancia mínima al borde	Espesor mínimo del fondo de la losa	profundidad del taladro	profundidad de instalación	longitud del perno*	distancia crítica entre anclajes	distancia crítica al borde	Útil de instalación
[--]	[--]	[--]	ETA	d_0	d_f	T_{ins}	s_{min}	c_{min}	d_b	h_1	h_{nom}	e	$s_{cr,N}$	$c_{cr,N}$	[--]
				[--]	[--]	[--]	[--]	[--]	[--]	[--]	[--]	[--]	[--]	[--]	[--]
HE-HC	HEHCM08	M8 x 25 Ø10	✓	10	9	11	200	150	35	28	25	8 – 13	200	150	EXHBM08C
	HEHCM10	M10 x 25 Ø12	✓	12	12	17	200	150	35	28	25	10 – 17	200	150	EXHBM10C
	HEHCM12	M12 x 25 Ø15	✓	15	14	38	200	150	35	29	25	12 – 21	200	150	EXHBM12C

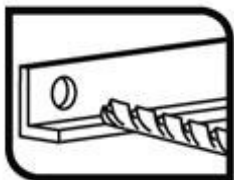
5. PROCESO DE INSTALACIÓN**5.1. INSTALACIÓN EN HORMIGÓN Y LOSAS ALVEOLARES****1. TALADRAR**

Comprobar que el hormigón esté bien compactado y sin poros significativos.

Admisible en taladros secos, húmedos o inundados.

Taladro en posición percusión o martillo.

Taladrar a diámetro y profundidad especificados.

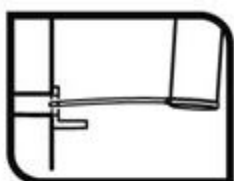
**2. SOPLAR Y LIMPIAR**

Limpiar el agujero de restos de polvo y fragmentos del taladrado.

Utilizar bomba de aire y cepillo.

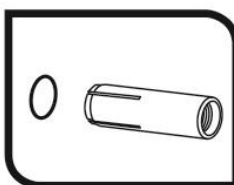
**3. INSTALAR**

Insertar el anclaje hasta el fondo del taladro.

Utilizar un martillo en caso necesario.

El anclaje debe quedar rasante con el material base.

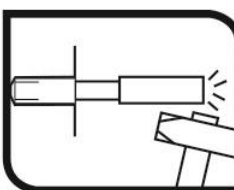
**4. EXPANSIONAR EL ANCLAJE**

Aplicar el útil de colocación correspondiente sobre el cono interior del anclaje.

Golpear con un martillo hasta que el reborde del útil de colocación quede a ras de la boca del anclaje.

6. RESISTENCIAS EN HORMIGON

Resistencias en hormigón C20/25 para un anclaje aislado sin efectos de distancia al borde ni de distancias entre anclajes es la indicada en la siguiente tabla:

6.1 RESISTENCIAS CARACTERÍSTICAS [kN]

Parámetros generales			Aplicaciones Estructurales			Aplicaciones No estructurales		
Familia	Código	Medida	Homologado	Tracción	Cortadura	Homologado	Resistencia en cualquier dirección	
				N _{Rk}	V _{Rk}		F _{Rk}	
HE-HO	HEHOM06	M6 x 25 Ø8	✓	6,15	6,15	✓	2,00	
	HEHOM08	M8 x 30 Ø10	✓	8,08	8,08	✓	3,00	
	HEHOM10	M10 x 40 Ø12	✓	12,45	<u>9,10</u>	✓	5,00	
	HEHOM12	M12 x 50 Ø15	✓	17,39	17,39	✓	7,50	
	HEHOM16	M16 x 65 Ø20	✓	25,78	<u>32,50</u>	✓	12,0	
	HEHOM20	M20 x 80 Ø25	✓	35,20	<u>47,50</u>	✓	20,0	
	HEHOM12D	M12 x 50 Ø16	--	17,39	17,39	✓	6,0	
HE-NO	HENOM06	M6 x 25 Ø8	--	5,04	6,15	--	--	
	HENOM08	M8 x 30 Ø10	--	6,63	8,08	--	--	
	HENOM10	M10 x 40 Ø12	--	10,20	<u>9,10</u>	--	--	
	HENOM12	M12 x 50 Ø15	--	14,26	17,39	--	--	
	HENOM16	M16 x 65 Ø20	--	21,13	<u>32,50</u>	--	--	
	HENOM20	M20 x 80 Ø25	--	28,85	<u>47,50</u>	--	--	
	HECLOM06	M6 x 25 Ø8	✓	6,15	6,15	✓	2,00	
HE-CL	HECLOM08	M8 x 30 Ø10	✓	8,08	8,08	✓	3,00	
	HECLOM10	M10 x 40 Ø12	✓	12,45	<u>9,10</u>	✓	5,00	
	HECLOM12	M12 x 50 Ø15	✓	17,39	17,39	✓	7,50	
	HECLOM16	M16 x 65 Ø20	✓	25,78	<u>32,50</u>	✓	12,0	
	HECLOM12D	M12 x 50 Ø16	--	17,39	17,39	✓	6,00	
	HE-A4	HEA4M06	M6 x 25 Ø8	--	2,50	2,50	✓	2,50
		HEA4M08	M8 x 30 Ø10	--	3,50	3,50	✓	3,50
HEA4M10		M10 x 40 Ø12	--	3,50	3,50	✓	3,50	
HEA4M12		M12 x 50 Ø15	--	6,50	6,50	✓	6,50	
HEA4M16		M16 x 65 Ø20	--	12,50	12,50	✓	12,50	
HEA4M20		M20 x 80 Ø25	--	16,50	16,50	✓	16,50	
HE-NS		HENSM06	M6 x 25 Ø8	--	6,15	6,15	--	--
	HENSM08	M8 x 30 Ø10	--	8,08	8,08	--	--	
	HENSM10	M10 x 40 Ø12	--	12,45	<u>9,10</u>	--	--	
	HENSM12	M12 x 50 Ø15	--	17,39	17,39	--	--	
	HENSM16	M16 x 65 Ø20	--	25,78	<u>32,50</u>	--	--	
	HE-HC	HEHCM08	M8 x 25 Ø10	--	--	--	✓	2,5
HEHCM10		M10 x 25 Ø12	--	--	--	✓	4,0	
HEHCM12		M12 x 25 Ø15	--	--	--	✓	4,0	

1 kN ≈ 100 kg

Los valores subrayados y en cursiva indican fallo del acero, los valores en **negrita** indican fallo por hormigón y el resto indica fallo por extracción.

6.2 RESISTENCIAS DE CALCULO [kN]

Parámetros generales			Aplicaciones Estructurales			Aplicaciones No estructurales	
Familia	Código	Medida	Homologado	Tracción	Cortadura	Homologado	Resistencia en cualquier dirección
				N _{Rd}	V _{Rd}		F _{Rd}
HE-HO	HEHOM06	M6 x 25 Ø8	✓	3,42	4,10	✓	1,11
	HEHOM08	M8 x 30 Ø10	✓	4,49	5,39	✓	1,67
	HEHOM10	M10 x 40 Ø12	✓	5,93	<u>7,28</u>	✓	2,38
	HEHOM12	M12 x 50 Ø15	✓	8,28	11,60	✓	3,57
	HEHOM16	M16 x 65 Ø20	✓	12,28	<u>26,00</u>	✓	5,71
	HEHOM20	M20 x 80 Ø25	✓	16,76	<u>38,00</u>	✓	9,52
HE-NO	HEHOM12D	M12 x 50 Ø16	--	8,28	11,60	✓	2,86
	HENOM06	M6 x 25 Ø8	--	2,40	4,10	--	--
	HENOM08	M8 x 30 Ø10	--	3,15	5,39	--	--
	HENOM10	M10 x 40 Ø12	--	4,86	<u>7,28</u>	--	--
	HENOM12	M12 x 50 Ø15	--	6,79	11,60	--	--
	HENOM16	M16 x 65 Ø20	--	10,06	<u>26,00</u>	--	--
HE-CL	HENOM20	M20 x 80 Ø25	--	13,74	<u>38,00</u>	--	--
	HECLOM06	M6 x 25 Ø8	✓	3,42	4,10	✓	1,11
	HECLOM08	M8 x 30 Ø10	✓	4,49	5,39	✓	1,67
	HECLOM10	M10 x 40 Ø12	✓	5,93	<u>7,28</u>	✓	2,38
	HECLOM12	M12 x 50 Ø15	✓	8,28	11,60	✓	3,57
	HECLOM16	M16 x 65 Ø20	✓	12,28	<u>26,00</u>	✓	5,71
HE-A4	HECLOM12D	M12 x 50 Ø16	--	8,28	11,60	✓	2,86
	HEA4M06	M6 x 25 Ø8	--	1,19	1,19	✓	1,19
	HEA4M08	M8 x 30 Ø10	--	1,67	1,67	✓	1,67
	HEA4M10	M10 x 40 Ø12	--	1,67	1,67	✓	1,67
	HEA4M12	M12 x 50 Ø15	--	3,10	3,10	✓	3,10
	HEA4M16	M16 x 65 Ø20	--	5,95	5,95	✓	5,95
HE-NS	HEA4M20	M20 x 80 Ø25	--	7,86	7,86	✓	7,86
	HENSM06	M6 x 25 Ø8	--	3,42	4,10	--	--
	HENSM08	M8 x 30 Ø10	--	4,49	5,39	--	--
	HENSM10	M10 x 40 Ø12	--	5,93	<u>7,28</u>	--	--
	HENSM12	M12 x 50 Ø15	--	8,28	11,60	--	--
HE-HC	HENSM16	M16 x 65 Ø20	--	12,28	<u>26,00</u>	--	--
	HEHCM08	M8 x 25 Ø10	--	--	--	✓	1,39
	HEHCM10	M10 x 25 Ø12	--	--	--	✓	2,22
	HEHCM12	M12 x 25 Ø15	--	--	--	✓	2,22

1 kN ≈ 100 kg

Los valores *subrayados y en cursiva* indican fallo del acero, los valores en **negrita** indican fallo por hormigón y el resto indica fallo por extracción.

6.3 CARGAS MÁXIMAS RECOMENDADAS [kN]

Parámetros generales			Aplicaciones Estructurales			Aplicaciones No estructurales	
Familia	Código	Medida	Homologado	Tracción	Cortadura	Homologado	Resistencia en cualquier dirección
				N _{rec}	V _{rec}		F _{rec}
HE-HO	HEHOM06	M6 x 25 Ø8	✓	2,44	2,93	✓	0,79
	HEHOM08	M8 x 30 Ø10	✓	3,21	3,85	✓	1,19
	HEHOM10	M10 x 40 Ø12	✓	4,23	<u>5,20</u>	✓	1,70
	HEHOM12	M12 x 50 Ø15	✓	5,92	8,28	✓	2,55
	HEHOM16	M16 x 65 Ø20	✓	8,77	<u>18,57</u>	✓	4,08
	HEHOM20	M20 x 80 Ø25	✓	11,97	<u>27,14</u>	✓	6,80
	HEHOM12D	M12 x 50 Ø16	--	5,92	8,28	✓	1,19
HE-NO	HENOM06	M6 x 25 Ø8	--	1,71	2,93	--	--
	HENOM08	M8 x 30 Ø10	--	2,25	3,85	--	--
	HENOM10	M10 x 40 Ø12	--	3,47	<u>5,20</u>	--	--
	HENOM12	M12 x 50 Ø15	--	4,85	8,28	--	--
	HENOM16	M16 x 65 Ø20	--	7,19	<u>18,57</u>	--	--
	HENOM20	M20 x 80 Ø25	--	9,81	<u>27,14</u>	--	--
	HECLOM12D	M12 x 50 Ø16	--	5,92	8,28	✓	2,04
HE-CL	HECLOM06	M6 x 25 Ø8	✓	2,44	2,93	✓	0,79
	HECLOM08	M8 x 30 Ø10	✓	3,21	3,85	✓	1,19
	HECLOM10	M10 x 40 Ø12	✓	4,23	<u>5,20</u>	✓	1,70
	HECLOM12	M12 x 50 Ø15	✓	5,92	8,28	✓	2,55
	HECLOM16	M16 x 65 Ø20	✓	8,77	<u>18,57</u>	✓	4,08
	HECLOM12D	M12 x 50 Ø16	--	5,92	8,28	✓	2,04
	HEA4M06	M6 x 25 Ø8	--	0,85	0,85	✓	0,85
HE-A4	HEA4M08	M8 x 30 Ø10	--	1,19	1,19	✓	1,19
	HEA4M10	M10 x 40 Ø12	--	1,19	1,19	✓	1,19
	HEA4M12	M12 x 50 Ø15	--	2,21	2,21	✓	2,21
	HEA4M16	M16 x 65 Ø20	--	4,25	4,25	✓	4,25
	HEA4M20	M20 x 80 Ø25	--	5,61	5,61	✓	5,61
	HENSM06	M6 x 25 Ø8	--	2,44	2,93	--	--
HE-NS	HENSM08	M8 x 30 Ø10	--	3,21	3,85	--	--
	HENSM10	M10 x 40 Ø12	--	4,23	<u>5,20</u>	--	--
	HENSM12	M12 x 50 Ø15	--	5,92	8,28	--	--
	HENSM16	M16 x 65 Ø20	--	8,77	<u>18,57</u>	--	--
	HEHCM08	M8 x 25 Ø10	--	--	--	✓	0,99
HE-HC	HEHCM10	M10 x 25 Ø12	--	--	--	✓	1,59
	HEHCM12	M12 x 25 Ø15	--	--	--	✓	1,59

1 kN ≈ 100 kg
Los valores *subrayados y en cursiva* indican fallo del acero, los valores en **negrita** indican fallo por hormigón y el resto indica fallo por extracción.

7. RESISTENCIAS EN LOSAS ALVEOLARES

Resistencia en losas alveolares pretensadas desde C30/37 a C50/60 para un anclaje aislado sin efectos de distancia al borde ni de distancias entre anclajes es la indicada en la siguiente tabla:

7.1 RESISTENCIAS

Parámetros generales				Resistencia en todas las direcciones [F _{Rk}] (Aplicaciones No estructurales)		
Familia	Código	Medida	Homologado	CARACTERÍSTICAS [kN]	CALCULO [kN]	CARGAS MÁXIMAS RECOMENDADAS [kN]
HE-HC	HEHCM08	M8 x 25 Ø10	✓	5,5	3,06	2,18
	HEHCM10	M10 x 25 Ø12	✓	6,0	2,86	2,04
	HEHCM12	M12 x 25 Ø15	✓	6,5	3,10	2,21

1 kN ≈ 100 kg

8. DOCUMENTACIÓN OFICIAL

A través de nuestro departamento comercial o de nuestra página web www.indexfix.com puede obtener los siguientes documentos:

- Homologación europea ETA 14/0135 para instalación en hormigón no fisurado según guía EAD 330232-00-0601, opción 7, de M6 a M20.
- Homologación europea ETA 14/0068 para aplicaciones no estructurales en sistemas redundantes en sistemas redundantes en hormigón fisurado y no fisurado según guía EAD 330747-00-0601, opción 7, de M6 a M20.
- Declaración de prestaciones DoP HE.
- Certificado VdS CEA 4001:2021-01(07) *Guidelines for sprinklers systems. Planning and installation for applications of water extinguishing systems on concrete elements* de M8 a M20.
- Certificado FM *Pipe Hanger Components for Automatic Sprinkler Systems* de M10 a M16
- Disponible para el programa de cálculo de anclajes INDEXcal.