



HIT-HY 200 R V3 INJECTION MORTAR

Technical Datasheet

Update: Jan-21



HIT-HY 200-R V3 injection mortar

Anchor design (EN 1992-4) / Rods&Sleeves / Concrete

Injection mortar system



Hilti HIT-HY 200-R V3

500 ml foil pack
(also available as 330 ml foil pack)



Anchor rod:
HAS-U
HAS-U HDG
HAS-U A4
HAS-U HCR
(M8-M30)



Internally threaded sleeve:
HIS-N
HIS-RN
(M8-M20)

Benefits

- **SafeSet** technology: Simplified method of borehole preparation using either Hilti hollow drill bit for hammer drilling or Roughening tool for diamond cored applications
- Suitable for uncracked and cracked concrete C 20/25 to C 50/60
- ETA Approved for seismic performance category C1, C2^{a)}
- Maximum load performance in cracked concrete and uncracked concrete
- High corrosion / corrosion resistance^{b)}
- Small edge distance and anchor spacing possible
- Manual cleaning for borehole diameter up to 20mm and $h_{ef} \leq 10d$ for uncracked concrete only

a) HIS-N internally threaded sleeves not approved for Seismic.

b) High Corrosion resistant rods available only for HAS-U. Corrosion resistant rods available for HAS-U and HIS-N.

Base material



Concrete (uncracked)



Concrete (cracked)

Installation conditions

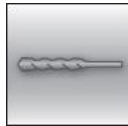

Hammer drilled holes



Diamond drilled holes^{c)}

SAFE-SET

Hilti **SafeSet** technology

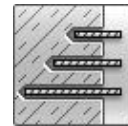

Variable embedment depth

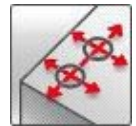

Small edge distance and spacing

Load conditions

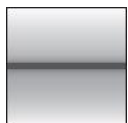

Static/
quasi-static



Seismic,
ETA-C1, C2^{a)}



Fire
resistance



European
Technical
Assessment



CE
conformity

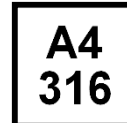

Corrosion
resistance^{b)}



High
corrosion
resistance^{b)}



PROFIS
Anchor design
Software

Other information

a) HIS-N internally threaded sleeves not approved for Seismic.

b) High Corrosion resistant rods available only for HAS-U. Corrosion resistant rods available for HAS-U and HIS-N.

c) Diamond drilling only with Roughening Tool (RT) for HAS-U and HIS-N.

Approvals / certificates

Description	Product	Authority /	No. / date of issue
European Technical Assessment ^{a)}	HY 200-R V3	DIBt, Berlin	ETA-19/0601 / 2019-12-10

a) All data given in this section according to the ETA-19/0601, issue 2019-12-10.

Static and quasi-static resistance (for a single anchor)

All data in this section applies to:

- Correct setting (See setting instruction)
- No edge distance and spacing influence
- Steel failure
- Minimum base material thickness
- One typical embedment depth, as specified in the table
- One anchor material, as specified in the tables
- Concrete C 20/25, $f_{ck,cube} = 25 \text{ N/mm}^2$
- Temperature range I (min. base material temp. -40°C , max. long/short term base material temp.: $+24^\circ\text{C}/40^\circ\text{C}$)
- Short term loading. For long term loading please apply $\psi_{sus} = 0.74$.

For hammer drilled holes, hammer drilled holes with Hilti hollow drill bit:

Anchorage depth ¹⁾

Anchor size		M8	M10	M12	M16	M20	M24	M27	M30
HAS-U									
Embedment depth	[mm]	80	90	110	125	170	210	240	270
Base material thickness	[mm]	110	120	140	160	220	270	300	340
HIS-N									
Embedment depth	[mm]	90	110	125	170	205	-	-	-
Base material thickness	[mm]	120	150	170	230	270	-	-	-

1) The allowed range of embedment depth is shown in the setting details.

2) For combined pull-out and concrete cone failure

3) For concrete cone failure

Characteristic resistance

Anchor size		M8	M10	M12	M16	M20	M24	M27	M30
Uncracked concrete									
Tension N_{Rk}	HAS-U 5.8	18,0	29,0	42,0	68,7	109	150	183	218
	HAS-U 8.8	29,0	42,0	56,8	68,7	109	150	183	218
	HAS-U A4	26,0	41,0	56,8	68,7	109	150	183	218
	HAS-U HCR	29,0	42,0	56,8	68,7	109	150	183	218
	HIS-N 8.8	25,0	46,0	67,0	109	116	-	-	-
Shear V_{Rk}	HAS-U 5.8	9,0	15,0	21,0	39,0	61,0	88,0	115	140
	HAS-U 8.8	15,0	23,0	34,0	63,0	98,0	141	184	224
	HAS-U A4	13,0	20,0	30,0	55,0	86,0	124	115	140
	HAS-U HCR	15,0	23,0	34,0	63,0	98,0	124	161	196
	HIS-N 8.8	13,0	23,0	34,0	63,0	58,0	-	-	-
Cracked concrete									
Tension N_{Rk}	HAS-U 5.8	15,1	21,2	35,2	48,1	76,3	105	128	153
	HAS-U 8.8	15,1	21,2	35,2	48,1	76,3	105	128	153
	HAS-U A4	15,1	21,2	35,2	48,1	76,3	105	128	153
	HAS-U HCR	15,1	21,2	35,2	48,1	76,3	105	128	153
	HIS-N 8.8	24,7	39,7	48,1	76,3	101	-	-	-
Shear V_{Rk}	HAS-U 5.8	9,0	15,0	21,0	39,0	61,0	88,0	115	140
	HAS-U 8.8	15,0	23,0	34,0	63,0	98,0	141	184	224
	HAS-U A4	13,0	20,0	30,0	55,0	86,0	124	115	140
	HAS-U HCR	15,0	23,0	34,0	63,0	98,0	124	161	196
	HIS-N 8.8	13,0	23,0	34,0	63,0	58,0	-	-	-

Design resistance

Anchor size		M8	M10	M12	M16	M20	M24	M27	M30
Uncracked concrete									
Tension N_{Rd}	HAS-U 5.8	12,0	19,3	28,0	45,8	72,7	99,8	122	146
	HAS-U 8.8	19,3	28,0	37,8	45,8	72,7	99,8	122	146
	HAS-U A4 [kN]	13,9	21,9	31,6	45,8	72,7	99,8	80,4	98,3
	HAS-U HCR	19,3	28,0	37,8	45,8	72,7	99,8	122	146
	HIS-N 8.8	16,7	30,7	44,7	72,7	77,3	-	-	-
Shear V_{Rd}	HAS-U 5.8	7,2	12,0	16,8	31,2	48,8	70,4	92,0	112
	HAS-U 8.8	12,0	18,4	27,2	50,4	78,4	113	147	179
	HAS-U A4 [kN]	8,3	12,8	19,2	35,3	55,1	79,5	48,3	58,8
	HAS-U HCR	12,0	18,4	27,2	50,4	78,4	70,9	92,0	112
	HIS-N 8.8	10,4	18,4	27,2	50,4	46,4	-	-	-
Cracked concrete									
Tension N_{Rd}	HAS-U 5.8	10,1	14,1	23,5	32,1	50,9	69,9	85,4	102
	HAS-U 8.8	10,1	14,1	23,5	32,1	50,9	69,9	85,4	102
	HAS-U A4 [kN]	10,1	14,1	23,5	32,1	50,9	69,9	80,4	98,3
	HAS-U HCR	10,1	14,1	23,5	32,1	50,9	69,9	85,4	102
	HIS-N 8.8	16,5	26,5	32,1	50,9	67,4	-	-	-
Shear V_{Rd}	HAS-U 5.8	7,2	12,0	16,8	31,2	48,8	70,4	92,0	112
	HAS-U 8.8	12,0	18,4	27,2	50,4	78,4	113	147	179
	HAS-U A4 [kN]	8,3	12,8	19,2	35,3	55,1	79,5	48,3	58,8
	HAS-U HCR	12,0	18,4	27,2	50,4	78,4	70,9	92,0	112
	HIS-N 8.8	10,4	18,4	27,2	50,4	46,4	-	-	-

Seismic resistance (for a single anchor)

All data in this section applies to:

- Correct setting (See setting instruction with hammer drilling)
- No edge distance and spacing influence
- Steel failure
- Minimum base material thickness
- Concrete C 20/25, $f_{ck,cube} = 25 \text{ N/mm}^2$
- Temperature range I (min. base material temp. -40°C , max. long/short term base material temp.: $+24^\circ\text{C}/40^\circ\text{C}$)
- Installation temperature range -10°C to $+40^\circ\text{C}$
- $\alpha_{gap} = 1,0$ (using Hilti seismic filling set)

For hammer drilled holes and hammer drilled holes with Hilti hollow drill bit:

Anchorage depth for seismic C2

Anchor size		M8	M10	M12	M16	M20	M24	M27	M30
HAS-U									
Embedment depth	h_{ef} [mm]	-	-	-	125	170	210	-	-

Characteristic resistance in case of seismic performance category C2

Anchor size		M8	M10	M12	M16	M20	M24	M27	M30
Tension $N_{Rk,seis}$	HAS-U 8.8 [kN]	-	-	-	24,5	45,9	55,4	-	-
Shear $V_{Rk,seis}$	HAS-U 8.8 w/ filling set [kN]	-	-	-	46,0	77,0	103	-	-
	HAS-U 8.8 w/o filling set [kN]	-	-	-	40,0	71,0	90,0	-	-

Design resistance in case of seismic performance category C2

Anchor size		M8	M10	M12	M16	M20	M24	M27	M30
Tension $N_{Rd,seis}$	HAS-U 8.8 [kN]	-	-	-	16,3	30,6	36,9	-	-
Shear $V_{Rd,seis}$	HAS-U 8.8 w/ filling set [kN]	-	-	-	36,8	61,6	82,4	-	-
	HAS-U 8.8 w/o filling set [kN]	-	-	-	32,0	56,8	72,0	-	-

Anchorage depth for seismic C1

Anchor size			M8	M10	M12	M16	M20	M24	M27	M30
HAS-U										
Embedment depth	h_{ef}	[mm]	-	90	110	125	170	210	240	270

Characteristic resistance in case of seismic performance category C1

Anchor size			M8	M10	M12	M16	M20	M24	M27	M30
Tension $N_{Rk,seis}$	HAS-U 8.8	[kN]	-	14,7	29,0	44,0	72,5	99,6	122	145
Shear $V_{Rk,seis}$	HAS-U 8.8	[kN]	-	23,0	34,0	63,0	98,0	141	184	224

Design resistance in case of seismic performance category C1

Anchor size			M8	M10	M12	M16	M20	M24	M27	M30
Tension $N_{Rd,seis}$	HAS-U 8.8	[kN]	-	9,8	19,4	29,3	48,4	66,4	81,1	96,8
Shear $V_{Rd,seis}$	HAS-U 8.8	[kN]	-	18,4	27,2	50,4	78,4	113	145	173

Materials

Mechanical properties for HAS-U

Anchor size			M8	M10	M12	M16	M20	M24	M27	M30
Nominal tensile strength f_{uk}	HAS-U 5.8 (HDG)	[N/mm ²]	500	500	500	500	500	500	-	-
	HAS-U 8.8 (HDG)		800	800	800	800	800	800	800	800
	AM 8.8 (HDG)		700	700	700	700	700	700	500	500
	HAS-U A4		800	800	800	800	800	700	-	-
Yield strength f_{yk}	HAS-U 5.8 (HDG)	[N/mm ²]	440	440	440	440	400	400	-	-
	HAS-U 8.8 (HDG)		640	640	640	640	640	640	640	640
	AM 8.8 (HDG)		450	450	450	450	450	450	210	210
	HAS-U A4		640	640	640	640	640	400	-	-
Stressed cross-section A_s	HAS-U	[mm ²]	36,6	58,0	84,3	157	245	353	459	561
Moment of resistance W	HAS-U	[mm ³]	31,2	62,3	109	277	541	935	1387	1874

Mechanical properties for HIS-N

Anchor size			M8	M10	M12	M16	M20
Nominal tensile strength f_{uk}	HIS-N	[N/mm ²]	490	490	490	490	490
	Screw 8.8		800	800	800	800	800
	HIS-RN		700	700	700	700	700
	Screw 70		700	700	700	700	700
Yield strength f_{yk}	HIS-N	[N/mm ²]	390	390	390	390	390
	Screw 8.8		640	640	640	640	640
	HIS-RN		350	350	350	350	350
	Screw A4-70		450	450	450	450	450
Stressed cross-section A_s	HIS-(R)N	[mm ²]	51,5	108	169	256	238
	Screw		36,6	58,0	84,3	157	245
Moment of resistance W	HIS-(R)N	[mm ³]	145	430	840	1595	1543
	Screw		31,2	62,3	109	277	541



Material quality for HAS-U

Part	Material
Zinc coated steel	
Threaded rod, HAS-U 5.8 (HDG)	Strength class 5.8; Elongation at fracture A5 > 8% ductile Electroplated zinc coated $\geq 5\mu\text{m}$; (HDG) hot dip galvanized $\geq 45\mu\text{m}$
Threaded rod, HAS-U 8.8 (HDG)	Strength class 8.8; Elongation at fracture A5 > 12% ductile Electroplated zinc coated $\geq 5\mu\text{m}$; (HDG) hot dip galvanized $\geq 45\mu\text{m}$
Hilti Meter rod, AM 8.8 (HDG)	Strength class 8.8; Elongation at fracture A5 > 12% ductile Electroplated zinc coated $\geq 5\mu\text{m}$, (HDG) hot dip galvanized $\geq 45\mu\text{m}$
Washer	Electroplated zinc coated $\geq 5\mu\text{m}$, hot dip galvanized $\geq 45\mu\text{m}$
Nut	Strength class of nut adapted to strength class of threaded rod. Electroplated zinc coated $\geq 5\mu\text{m}$, (HDG) hot dip galvanized $\geq 45\mu\text{m}$
Hilti Filling set (F)	Filling washer: Electroplated zinc coated $\geq 5\mu\text{m}$ / (HDG) Hot dip galvanized $\geq 45\mu\text{m}$ Spherical washer: Electroplated zinc coated $\geq 5\mu\text{m}$ / (HDG) Hot dip galvanized $\geq 45\mu\text{m}$ Lock nut: Electroplated zinc coated $\geq 5\mu\text{m}$ / (HDG) Hot dip galvanized $\geq 45\mu\text{m}$
Stainless Steel	
Threaded rod, HAS-U A4	Strength class 70 for $\leq M24$ and strength class 50 for $> M24$; Elongation at fracture A5 > 8% ductile Stainless steel 1.4401; 1.4404; 1.4578; 1.4571; 1.4439; 1.4362 EN 10088-1:2014
Washer	Stainless steel 1.4401, 1.4404, 1.4578, 1.4571, 1.4439, 1.4362 EN 10088-1:2014
Nut	Strength class 70 for $\leq M24$ and strength class 50 for $> M24$; Stainless steel 1.4401, 1.4404, 1.4578, 1.4571, 1.4439, 1.4362 EN 10088-1:2014
High corrosion resistant steel	
Threaded rod, HAS-U HCR	Strength class 80 for $\leq M20$ and class 70 for $> M20$, Elongation at fracture A5 > 8% ductile High corrosion resistant steel 1.4529, 1.4565 EN 10088-1:2014
Washer	High corrosion resistant steel 1.4529, 1.4565 EN 10088-1:2014
Nut	Strength class 80 for $\leq M20$ and class 70 for $> M20$, High corrosion resistant steel 1.4529, 1.4565 EN 10088-1:2014

Material quality for HIS-N

Part	Material
HIS-N Int. threaded sleeve	Electroplated zinc coated $\geq 5\mu\text{m}$
HIS-RN Int. threaded sleeve	Stainless steel 1.4401, 1.4571 EN 10088-1:2014

Setting information

In service temperature range

Hilti HIT-HY 200-R V3 injection mortar with anchor rod HAS-U / HIS-(R)N may be applied in the temperature ranges given below. An elevated base material temperature leads to a reduction of the design bond resistance.

Temperature in the base material

Temperature range	Base material temperature	Maximum long term base material temperature	Maximum short term base material temperature
Temperature range I	-40 °C to +40 °C	+24 °C	+40 °C
Temperature range II	-40 °C to +80 °C	+50 °C	+80 °C
Temperature range III	-40 °C to +120 °C	+72 °C	+120 °C

Max short term base material temperature

Short-term elevated base material temperatures are those that occur over brief intervals, e.g. as a result of diurnal cycling.

Max long term base material temperature

Long-term elevated base material temperatures are roughly constant over significant periods of time.

Curing and working time

Temperature of the base material	HIT-HY 200-R V3	
	Maximum working time t_{work}	Minimum curing time t_{cure}
$-10^{\circ}\text{C} < T_{BM} \leq -5^{\circ}\text{C}$	3 h	20 h
$-5^{\circ}\text{C} < T_{BM} \leq 0^{\circ}\text{C}$	1,5 h	8 h
$0^{\circ}\text{C} < T_{BM} \leq 5^{\circ}\text{C}$	45 min	4 h
$5^{\circ}\text{C} < T_{BM} \leq 10^{\circ}\text{C}$	30 min	2,5 h
$10^{\circ}\text{C} < T_{BM} \leq 20^{\circ}\text{C}$	15 min	1,5 h
$20^{\circ}\text{C} < T_{BM} \leq 30^{\circ}\text{C}$	9 min	1 h
$30^{\circ}\text{C} < T_{BM} \leq 40^{\circ}\text{C}$	6 min	1 h

Setting details for HAS-U

Anchor size	M8	M10	M12	M16	M20	M24	M27	M30	
Nominal diameter of drill bit d_0 [mm]	10	12	14	18	22	28	30	35	
Eff. embedment depth and drill hole depth ^{a)}	$h_{ef,min}$ [mm]	60	60	70	80	90	96	108	120
	$h_{ef,max}$ [mm]	160	200	240	320	400	480	540	600
Minimum base material thickness	h_{min} [mm]	$h_{ef} + 30 \text{ mm} \geq 100 \text{ mm}$			$h_{ef} + 2 d_0$				
Maximum diameter of clearance hole in the fixture	d_f [mm]	9	12	14	18	22	26	30	33
Thickness of Hilti filling set	h_{fs} [mm]	-	-	-	11	13	15	-	-
Effective fixture thickness with Hilti filling set	$t_{fix,eff}$ [mm]	$t_{fix} - h_{fs}$							
Max. torque moment ^{b)}	T_{max} [Nm]	10	20	40	80	150	200	270	300
Minimum spacing	s_{min} [mm]	40	50	60	75	90	115	120	140
Minimum edge distance	c_{min} [mm]	40	45	45	50	55	60	75	80
Critical spacing for splitting failure	$s_{cr,sp}$ [mm]	$2 C_{cr,sp}$							
Critical edge distance for splitting failure ^{c)}	$C_{cr,sp}$ [mm]	$1,0 \cdot h_{ef}$ for $h / h_{ef} \geq 2,00$							
		$4,6 h_{ef} - 1,8 h$ for $2,00 > h / h_{ef} > 1,3$							
		$2,26 h_{ef}$ for $h / h_{ef} \leq 1,3$							
Critical spacing for concrete cone failure	$s_{cr,N}$ [mm]	$2 C_{cr,sp}$							
Critical edge distance for concrete cone failure ^{d)}	$C_{cr,N}$ [mm]	$1,5 h_{ef}$							

For spacing (edge distance) smaller than critical spacing (critical edge distance) the design loads have to be reduced.

- a) $h_{ef,min} \leq h_{ef} \leq h_{ef,max}$ (h_{ef} : embedment depth)
- b) Maximum recommended torque moment to avoid splitting failure during installation with minimum spacing and edge distance
- c) h : base material thickness ($h \geq h_{min}$)
- d) The critical edge distance for concrete cone failure depends on the embedment depth h_{ef} and the design bond resistance. The simplified formula given in this table is on the same side.

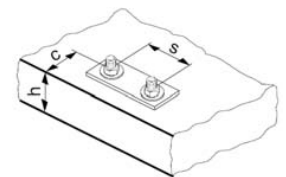

HAS-U-...



Marking:

Steel grade number and length identification letter: e.g. 8L

Setting details for HIS-N

Anchor size		M8	M10	M12	M16	M20
Nominal diameter of drill bit d_0	[mm]	14	18	22	28	32
Diameter of element d	[mm]	12,5	16,5	20,5	25,4	27,6
Effective anchorage and drill hole depth h_{ef}	[mm]	90	110	125	170	205
Minimum base material thickness h_{min}	[mm]	120	150	170	230	270
Diameter of clearance hole in the fixture d_f	[mm]	9	12	14	18	22
Thread engagement length; min - max h_s	[mm]	8-20	10-25	12-30	16-40	20-50
Minimum spacing s_{min}	[mm]	60	75	90	115	130
Minimum edge distance c_{min}	[mm]	40	45	55	65	90
Critical spacing for splitting failure $s_{cr,sp}$	[mm]	$2 c_{cr,sp}$				
Critical edge distance for splitting failure ^{b)} $c_{cr,sp}$	[mm]	$1,0 \cdot h_{ef}$ for $h / h_{ef} \geq 2,0$				
		$4,6 h_{ef} - 1,8 h$ for $2,0 > h / h_{ef} > 1,3$				
		$2,26 h_{ef}$ for $h / h_{ef} \leq 1,3$				
Critical spacing for concrete cone failure $s_{cr,N}$	[mm]	$2 c_{cr,N}$				
Critical edge distance for concrete cone failure ^{c)} $c_{cr,N}$	[mm]	$1,5 h_{ef}$				
Max. torque moment ^{a)} T_{max}	[Nm]	10	20	40	80	150

For spacing (edge distance) smaller than critical spacing (critical edge distance) the design loads have to be reduced.

- a) Max. recommended torque moment to avoid splitting failure during Installation with minimum spacing and edge distance
- b) h : base material thickness ($h \geq h_{min}$)
- c) The critical edge distance for concrete cone failure depends on the embedment depth h_{ef} and the design bond resistance. The simplified formula given in this table is on the safe side.

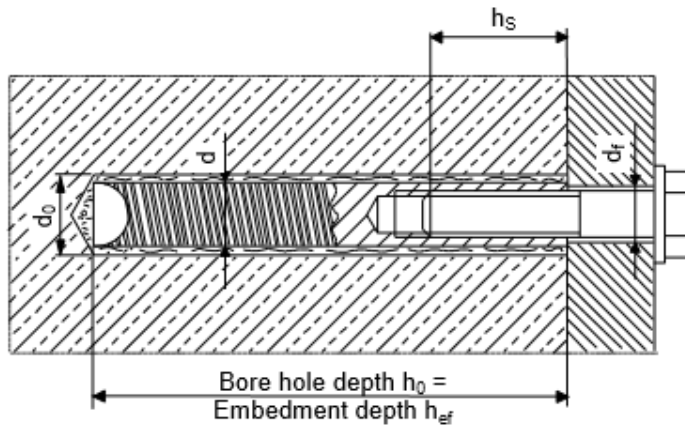
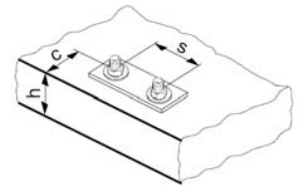

Installation equipment

Anchor size	M8	M10	M12	M16	M20	M24	M27	M30
Rotary hammer	HAS-U	TE 2 – TE 16			TE 40 - TE 80			
	HIS-N	TE (-A) – TE 16(-A)		TE 40 – TE 80		-		
Other tools	compressed air gun and blow out pump, set of cleaning brushes, dispenser Hollow Drill Bit							
	roughening tools TE-YRT							
Additional Hilti recommended tools	DD EC-1, DD 100 ... DD 160 ^{a)}							

a) For anchors in diamond drilled holes load values for combined pull-out and concrete cone resistance have to be reduced

Cleaning, drilling and installation parameters

HAS-U	HIS-N	Drill bit diameters d ₀ [mm]				Cleaning and installation	
		Hammer drill (HD)	Hollow Drill Bit (HDB)	Diamond coring		Brush HIT-RB	Piston plug HIT-SZ
				Diamond coring (DD)	With roughening tool (RT)		
M8	-	10	-	-	-	10	-
M10	-	12	12	-	-	12	12
M12	M8	14	14	-	-	14	14
M16	M10	18	18	18	18	18	18
M20	M12	22	22	22	22	22	22
M24	M16	28	28	28	28	28	28
M27	-	30	-	-	-	30	30
-	M20	32	32	32	32	32	32
M30	-	35	35	35	35	35	35

Associated components for the use of Hilti Roughening tool TE-YRT

Diamond coring		Roughening tool TE-YRT	Wear gauge RTG...
d ₀ [mm]		d ₀ [mm]	size
Nominal	measured		
18	17,9 to 18,2	18	18
20	19,9 to 20,2	20	20
22	21,9 to 22,2	22	22
25	24,9 to 25,2	25	25
28	27,9 to 28,2	28	28
30	29,9 to 30,2	30	30
32	31,9 to 32,2	32	32
35	34,9 to 35,2	35	35

Installation parameters for use of the Hilti Roughening tool TE-YRT

h _{ef} [mm]	Minimum roughening time t _{roughen} [sec] (t _{roughen} [sec] = h _{ef} [mm] / 10)	Minimum blowing time t _{blowing} [sec] (t _{blowing} [sec] = t _{roughen} [sec] + 20)
0 to 100	10	30
101 to 200	20	40
201 to 300	30	50
301 to 400	40	60
401 to 500	50	70
501 to 600	60	80

Setting instructions for HAS-U rods and HIS-N internally threaded sleeves

*For detailed information on installation see instruction for use given with the package of the product



Safety regulations.

Review the Material Safety Data Sheet (MSDS) before use for proper and safe handling! Wear well-fitting protective goggles and protective gloves when working with Hilti HIT-HY 200-R V3.

Drilling

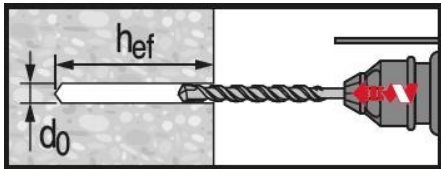

Hammer drilled hole (HD)

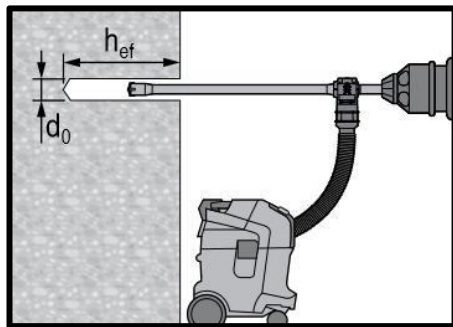

Hammer drilled hole with Hollow Drilled Bit (HDB)

No cleaning required

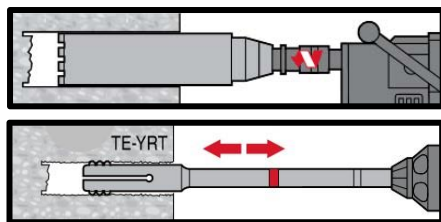

Diamond Drilling + Roughening Tool (DD+RT)

Cleaning

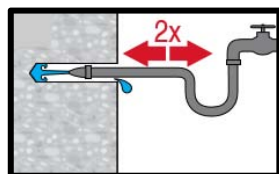

Flush 2 times by inserting a water hose (water-line pressure) to the back of the hole until water runs clear.

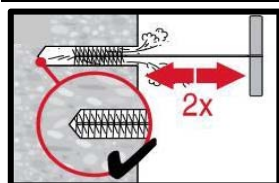

Brush 2 times with the specific brush by inserting the steel brush Hilti HIT-RB to the back of the hole in a twisting motion and removing it.

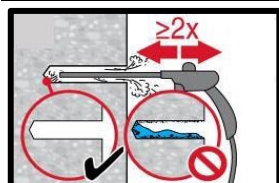

Blow 2 times from the back of the hole over the whole length with oil-free compressed air (min. 6 bar at 6 m³/h) until return air stream is free of noticeable dust and water. Remove all water from the drillhole until drillhole is completely dried before mortar injection.

Injection

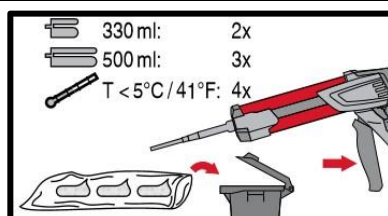
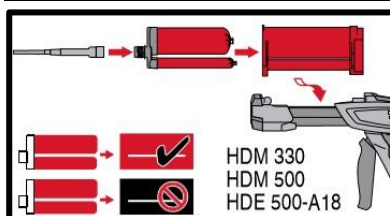

Injection system preparation.

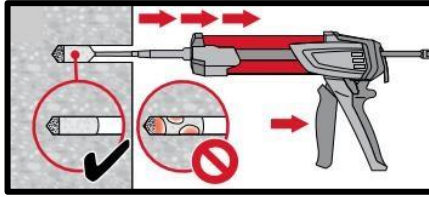
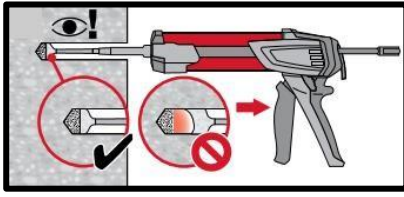

Injection method for drill hole depth $h_{ef} \leq 250$ mm.

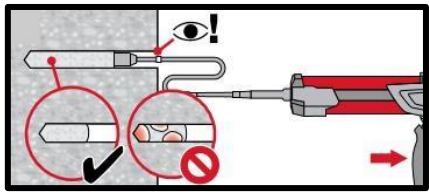
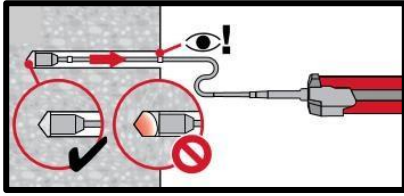

Injection method for drill hole depth $h_{ef} > 250$ mm.

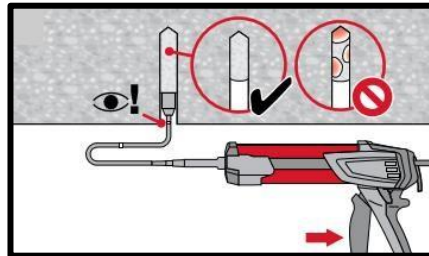
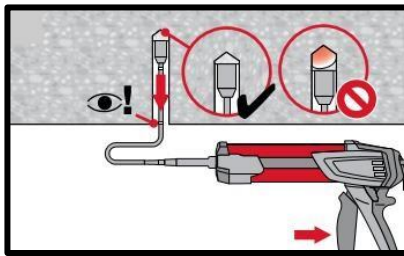

Injection method for overhead application and/or installation with embedment depth > 250 mm.

Setting the element

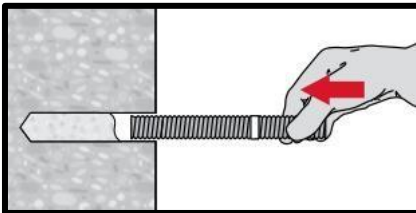

Setting element, observe working time " t_{work} ".

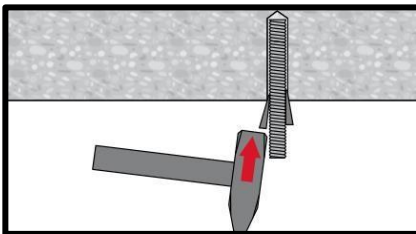

Setting element for overhead applications, observe working time " t_{work} ".

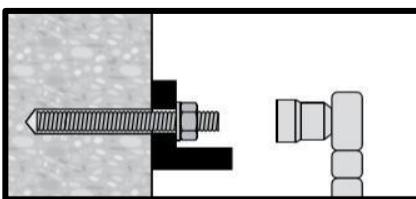

Loading the anchor after required curing time t_{cure}



HIT-HY 200-R V3 injection mortar

Anchor design (EN 1992-4) / Rebar elements / Concrete

Injection mortar system



Hilti HIT-HY 200-R V3

330 ml foil pack
(also available as 500 ml foil pack)



Rebar B500 B
(φ8 - φ32)

Benefits

- **SafeSet** technology: Simplified method of borehole preparation using either Hilti hollow drill bit for hammer drilling or Roughening tool for diamond cored applications
- Assessed following the EAD 332402-00-0601 "Post-Installed Reinforcing Bar (Rebar) Connections with Improved Bond-Splitting Behavior Under Static Loading".
- Allows the design of post-installed, moment-resisting reinforced concrete connections under static loading conditions without using a splice configuration according to TR 069
- ETA seismic approval C1
- Suitable for cracked and uncracked concrete C 12/15 to C 50/60
- Suitable for dry and water saturated concrete
- In service temperature range up to 120°C short term / 72°C long term
- Large diameter applications

Base material



Concrete (uncracked)



Concrete (cracked)



Dry concrete

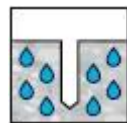

Wet concrete

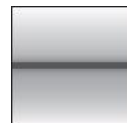

Static/
quasi-static



Seismic,
ETA-C1



Fire
resistance

Load conditions

Installation conditions



Hammer
drilling



Diamond
drilled
holes^{a)}



Variable
embedment
depth

SAFESET

Hilti **SafeSet**
technology

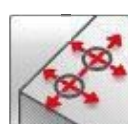

Small edge
distance
and
spacing

Other informations



European
Technical
Assessment



CE
conformity



PROFIS
Rebar design
Software

a) Diamond drilling only with Roughening Tool (RT).

Approvals / certificates

Description	Authority / Laboratory	No. / date of issue
European technical assessment ^{a)}	DIBt, Berlin	ETA-19/0601 / 2019-12-10

a) All data given in this section according to ETA-19/0601 issue 2019-12-10.

Static and quasi-static loading (for a single anchor)

All data in this section applies to

- Correct setting (See setting instruction)
- No edge distance and spacing influence
- Steel* failure
- Base material thickness, as specified in the table
- One typical embedment depth, as specified in the table
- One anchor material, as specified in the tables
- Concrete C 20/25, $f_{ck,cube} = 25 \text{ N/mm}^2$
- Temperature range I
(min. base material temperature -40°C , max. long term/short term base material temperature: $+24^\circ\text{C}/40^\circ\text{C}$)

Embedment depth and base material thickness for static and quasi-static loading data

Anchor size	$\phi 8$	$\phi 10$	$\phi 12$	$\phi 14$	$\phi 16$	$\phi 20$	$\phi 25$	$\phi 26$	$\phi 28$	$\phi 30$	$\phi 32$
Typical embedment depth [mm]	80	90	110	125	125	170	210	240	270	270	300
Base material thickness [mm]	110	120	140	160	170	220	280	310	340	350	380

Characteristic resistance

Anchor size	$\phi 8$	$\phi 10$	$\phi 12$	$\phi 14$	$\phi 16$	$\phi 20$	$\phi 25$	$\phi 26$	$\phi 28$	$\phi 30$	$\phi 32$
Uncracked concrete											
Tensile N_{Rk} [kN]	24,1	33,9	49,8	66,0	68,7	109	150	183	218	218	256
Shear V_{Rk} [kN]	14,0	22,0	31,0	42,0	55,0	86,0	135	146	169	194	221
Cracked concrete											
Tensile N_{Rk} [kN]	-	14,1	29,0	38,5	44,0	74,8	105	128	153	153	179
Shear V_{Rk} [kN]	-	22,0	31,0	42,0	55,0	86,0	135	146	169	194	221

Design resistance

Anchor size	$\phi 8$	$\phi 10$	$\phi 12$	$\phi 14$	$\phi 16$	$\phi 20$	$\phi 25$	$\phi 26$	$\phi 28$	$\phi 30$	$\phi 32$
Uncracked concrete											
Tensile N_{Rd} [kN]	16,1	22,6	33,2	44,0	45,8	72,7	99,8	122	146	146	170
Shear V_{Rd} [kN]	9,3	14,7	20,7	28,0	36,7	57,3	90,0	97,3	113	129	147
Cracked concrete											
Tensile N_{Rd} [kN]	-	9,4	19,4	25,7	29,3	49,8	69,9	85,4	102	102	119
Shear V_{Rd} [kN]	-	14,7	20,7	28,0	36,7	57,3	90,0	97,3	113	129	147

Seismic loading (for a single anchor)

All data in this section applies to:

- Correct setting (See setting)
- No edge distance and spacing influence
- Steel failure
- Minimum base material thickness
- Concrete C 20/25, $f_{ck,cube} = 25 \text{ N/mm}^2$
- Temperate range I
(min, base material temperature -40°C , max, long term/short term base material temperature: $+24^\circ\text{C}/40^\circ\text{C}$)
- $\alpha_{gap} = 1,0$

Embedment depth and base material thickness in case of seismic performance category C1

Anchor size	$\phi 8$	$\phi 10$	$\phi 12$	$\phi 14$	$\phi 16$	$\phi 20$	$\phi 25$	$\phi 26$	$\phi 28$	$\phi 30$	$\phi 32$
Typical embedment depth [mm]	-	90	110	125	125	170	210	240	270	270	300
Base material thickness [mm]	-	120	140	160	170	220	280	310	340	350	380

Characteristic resistance in case of seismic performance category C1

Anchor size	$\phi 8$	$\phi 10$	$\phi 12$	$\phi 14$	$\phi 16$	$\phi 20$	$\phi 25$	$\phi 26$	$\phi 28$	$\phi 30$	$\phi 32$
Tensile $N_{Rk, seis}$ [kN]	-	12,4	25,3	33,5	38,3	65,2	99,6	120	145	145	170
Shear $V_{Rk, seis}$ [kN]	-	15,0	22,0	29,0	39,0	60,0	95,0	102	118	136	155

Design resistance in case of seismic performance category C1

Anchor size	$\phi 8$	$\phi 10$	$\phi 12$	$\phi 14$	$\phi 16$	$\phi 20$	$\phi 25$	$\phi 26$	$\phi 28$	$\phi 30$	$\phi 32$
Tensile $N_{Rd, seis}$ [kN]	-	8,3	16,9	22,4	25,6	43,4	66,4	79,7	96,6	96,8	113
Shear $V_{Rd, seis}$ [kN]	-	10,0	14,7	19,3	26,0	40,0	63,3	68,0	78,7	90,7	103

Materials

Mechanical properties

Anchor size	$\phi 8$	$\phi 10$	$\phi 12$	$\phi 14$	$\phi 16$	$\phi 20$	$\phi 25$	$\phi 26$	$\phi 28$	$\phi 30$	$\phi 32$
Nominal tensile strength f_{uk} [N/mm ²]	550	550	550	550	550	550	550	550	550	550	550
Yield strength f_{yk} [N/mm ²]	500	500	500	500	500	500	500	550	500	550	500
Stressed cross-section A_s [mm ²]	50,3	78,5	113	154	201	314	491	531	616	707	804
Moment of resistance W [mm ³]	50,3	98,2	170	269	402	785	1534	1726	2155	2651	3217

Material quality

Part	Material
Rebar EN 1992-1-1:2004 and AC:2010	Bars and de-coiled rods class B or C according to NDP or NCL of EN 1992-1-1/NA

Setting information

Installation temperature range

- 10°C to + 40°C

Service temperature range

Hilti HIT-HY 200-R V3 injection mortar may be applied in the temperature ranges given below, An elevated base material temperature may lead to a reduction of the design bond resistance.

Temperature range	Base material temperature	Max, long term base material temperature	Max, short term base material temperature
Temperature range I	-40 °C to + 40 °C	+ 24 °C	+ 40 °C
Temperature range II	-40 °C to + 80 °C	+ 50 °C	+ 80 °C
Temperature range III	-40 °C to + 120 °C	+ 72 °C	+ 120 °C

Max, short term base material temperature

Short term elevated base material temperatures are those that occur over brief intervals, e.g, as a result of diurnal cycling.

Max, long term base material temperature

Long term elevated base material temperatures are roughly constant over significant periods of time.

Curing and working time

Temperature of the base material	HIT-HY 200-R	
	Maximum working time t_{work}	minimum curing time t_{cure}
- 10°C < $T_{BM} \leq - 5^\circ\text{C}$	3 h	20 h
- 5°C < $T_{BM} \leq 0^\circ\text{C}$	1,5 h	8 h
0°C < $T_{BM} \leq 5^\circ\text{C}$	45 min	4 h
5°C < $T_{BM} \leq 10^\circ\text{C}$	30 min	2,5 h
10°C < $T_{BM} \leq 20^\circ\text{C}$	15 min	1,5 h
20°C < $T_{BM} \leq 30^\circ\text{C}$	9 min	1 h
30°C < $T_{BM} \leq 40^\circ\text{C}$	6 min	1 h

Installation equipment

Anchor size	$\phi 8$	$\phi 10$	$\phi 12$	$\phi 14$	$\phi 16$	$\phi 20$	$\phi 25$	$\phi 26$	$\phi 28$	$\phi 30$	$\phi 32$
Rotary hammer	TE 2 (-A) – TE 16 (-A)					TE 40 – TE 80					
Other tools	Compressed air gun, blow out pump Set of cleaning brushes, dispenser										

Setting details



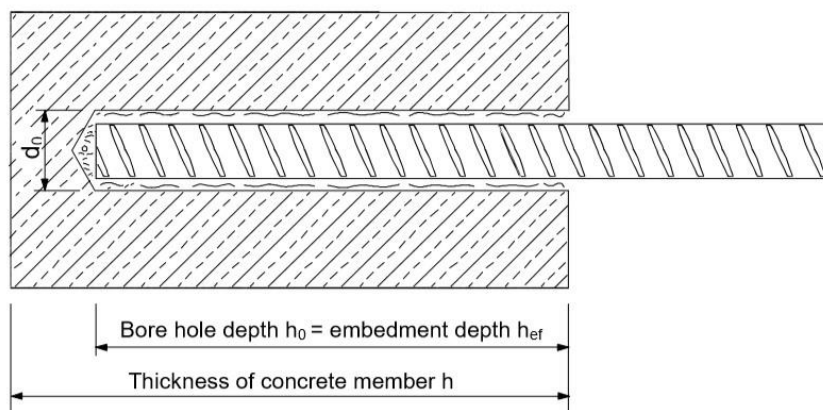
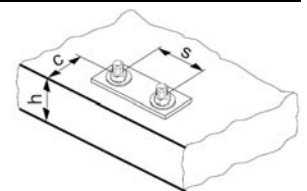

Anchor size			Ø8	Ø10	Ø12	Ø14	Ø16	Ø20	Ø25	Ø26	Ø28	Ø30	Ø32
Nominal diameter of drill bit	d_0	[mm]	10 / 12 ^{a)}	12 / 14 ^{a)}	14 / 16 ^{a)}	18	20	25	32	32	35	37	40
Effective anchorage and drill hole depth range ^{b)}	$h_{ef,min}$	[mm]	60	60	70	75	80	90	100	104	112	120	128
	$h_{ef,max}$	[mm]	160	200	240	280	320	400	500	520	560	600	640
Minimum base material thickness	h_{min}	[mm]	$h_{ef} + 30 \text{ mm} \geq 100 \text{ mm}$			$h_{ef} + 2 d_0$							
Minimum spacing	s_{min}	[mm]	40	50	60	70	80	100	125	130	140	150	160
Minimum edge distance	c_{min}	[mm]	40	45	45	50	50	65	70	75	75	80	80
Critical spacing for splitting failure	$s_{cr,sp}$	[mm]	$2 c_{cr,sp}$										
Critical edge distance for splitting failure ^{c)}	$c_{cr,sp}$	[mm]	$1,0 \cdot h_{ef}$		for $h / h_{ef} \geq 2,0$								
			$4,6 h_{ef} - 1,8 h$		for $2,0 > h / h_{ef} > 1,3$								
			$2,26 h_{ef}$		for $h / h_{ef} \leq 1,3$								
Critical spacing for concrete cone failure	$s_{cr,N}$	[mm]	$2 c_{cr,N}$										
Critical edge distance for concrete cone failure ^{d)}	$c_{cr,N}$	[mm]	$1,5 h_{ef}$										

For spacing (edge distance) smaller than critical spacing (critical edge distance) the design loads have to be reduced,

- a) Both given values for drill bit diameter can be used
- b) $h_{ef,min} \leq h_{ef} \leq h_{ef,max}$ (h_{ef} : embedment depth)
- c) h : base material thickness ($h \geq h_{min}$)
- d) The critical edge distance for concrete cone failure depends on the embedment depth h_{ef} and the design bond resistance. The simplified formula given in this table is on the safe side.





Drilling and cleaning diameters

Rebar	Hammer drill (HD)	Hollow Drill Bit (HDB)	Diamond coring with Roughening Tool (RT) ^{b)}	Brush HIT-RB
d ₀ [mm]				size [mm]
				
φ8	12 / 10 ^{a)}	12	-	12 / 10 ^{a)}
φ10	14 / 12 ^{a)}	14 / 12 ^{a)}	-	14 / 12 ^{a)}
φ12	16 / 14 ^{a)}	16 / 14 ^{a)}	-	16 / 14 ^{a)}
φ14	18	18	18	18
φ16	20	20	20	20
φ20	25	25	25	25
φ25	32	32	32	32
φ26	32	32	32	32
φ28	35	35	35	35
φ30	37	-	-	37
φ32	40	-	-	40

a) Both given values can be used

Associated components for the use of Hilti Roughening tool TE-YRT

Diamond coring		Roughening tool TE-YRT	Wear gauge RTG...
			
d ₀ [mm]		d ₀ [mm]	size
Nominal	measured		
18	17,9 to 18,2	18	18
20	19,9 to 20,2	20	20
22	21,9 to 22,2	22	22
25	24,9 to 25,2	25	25
28	27,9 to 28,2	28	28
30	29,9 to 30,2	30	30
32	31,9 to 32,2	32	32
35	34,9 to 35,2	35	35

Installation parameters for use of the Hilti Roughening tool TE-YRT

h _{ef} [mm]	Minimum roughening time t _{roughen} [sec] (t _{roughen} [sec] = h _{ef} [mm] / 10)	Minimum blowing time t _{blowing} [sec] (t _{blowing} [sec] = t _{roughen} [sec] + 20)
0 to 100	10	30
101 to 200	20	40
201 to 300	30	50
301 to 400	40	60
401 to 500	50	70
501 to 600	60	80

Setting instructions

*For detailed information on installation see instruction for use given with the package of the product,



Safety regulations.

Review the Material Safety Data Sheet (MSDS) before use for proper and safe handling! Wear well-fitting protective goggles and protective gloves when working with Hilti HIT-HY 200-R V3.

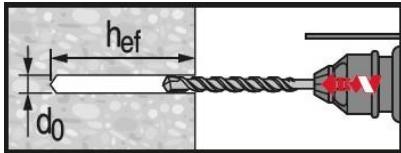

Hammer drilled hole (HD)

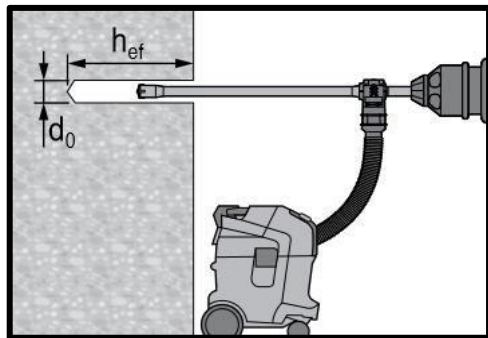

Hammer drilled hole with Hollow Drilled Bit (HDB)

No cleaning required

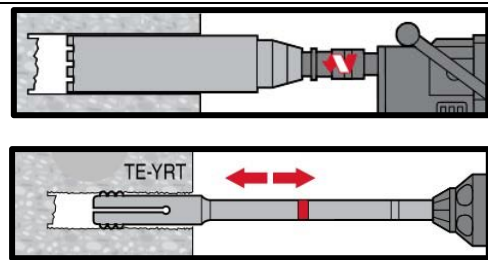

Diamond Drilling + Roughening Tool (DD+RT)

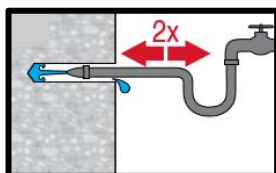

Flush 2 times by inserting a water hose (water-line pressure) to the back of the hole until water runs clear.

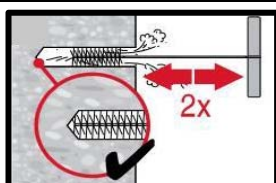

Brush 2 times with the specific brush by inserting the steel brush Hilti HIT-RB to the back of the hole in a twisting motion and removing it.

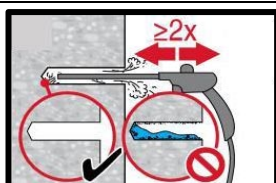

Blow 2 times from the back of the hole over the whole length with oil-free compressed air (min. 6 bar at 6 m³/h) until return air stream is free of noticeable dust and water. Remove all water from the drillhole until drillhole is completely dried before mortar injection.

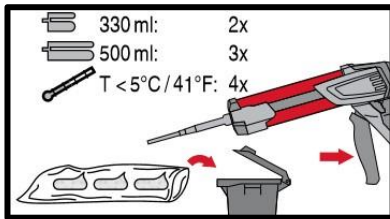
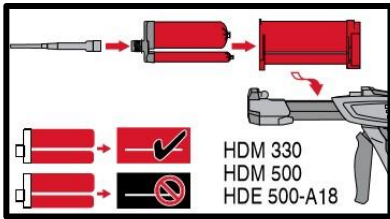

Injection system preparation.

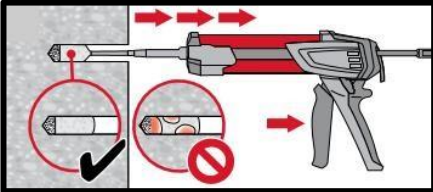
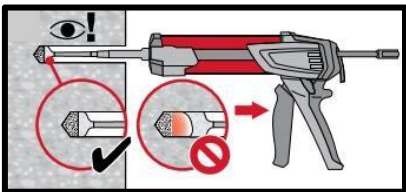

Injection method for drill hole depth $h_{ef} \leq 250$ mm.

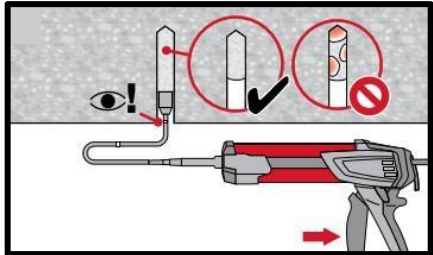
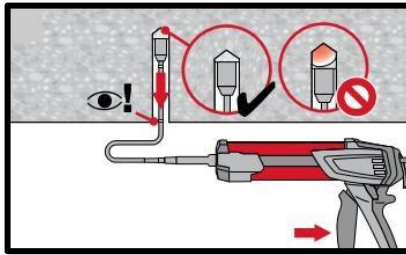

Injection method for overhead application and/or installations with embedment depth $h_{ef} \geq 250$ mm.

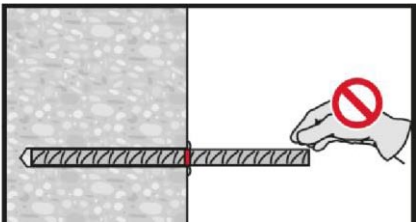
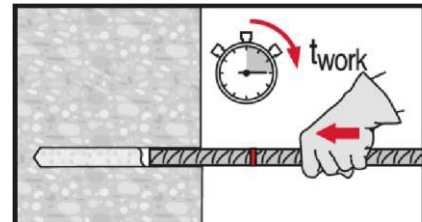

Setting element, observe working time "t_{work}".

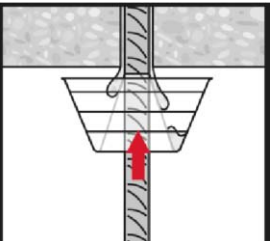
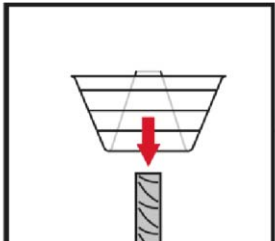
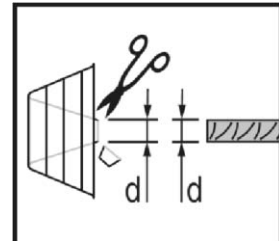

Setting element for overhead applications, observe working time "t_{work}".

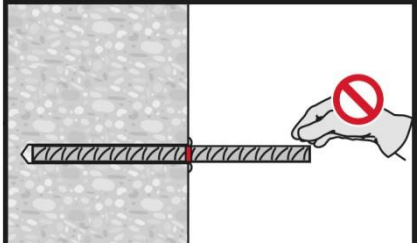
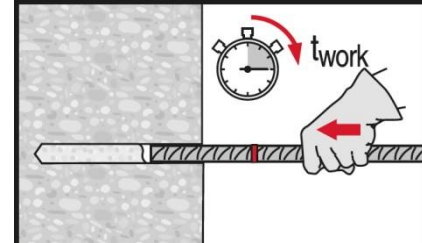















Setting element, observe working time "t_{work}".

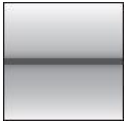

HIT-HY 200-R V3 injection mortar

Rebar design (EOTA TR023 & EOTA TR069) / Rebar elements / Concrete

Injection mortar system	Benefits
 <p>Hilti HIT-HY 200-R V3 330 ml foil pack (also available as 500 ml foil pack)</p>	<ul style="list-style-type: none"> - SafeSet technology: Simplified method of borehole preparation using either Hilti hollow drill bit for hammer drilling or Roughening tool for diamond cored applications - HY 200-R version is formulated for best handling and cure time specifically for rebar applications - Approved for ETA seismic C1 approval for post-installed-rebar - Suitable for concrete C 12/15 to C 50/60
 <p>Rebar ($\phi 8$ - $\phi 32$)</p>	<ul style="list-style-type: none"> - Suitable for dry and water saturated concrete - For rebar diameters up to 32 mm - Non corrosive to rebar elements - Good load capacity at elevated temperatures - Suitable for embedment length up to 1000 mm - Suitable for applications down to -10 °C

Base material	Load conditions
 <p>Concrete (uncracked)</p>  <p>Concrete (cracked)</p>  <p>Dry concrete</p>  <p>Wet concrete</p>	 <p>Static/ quasi-static</p>  <p>Seismic, ETA-C1</p>  <p>Fire resistance</p>
Installation conditions	Other informations
 <p>Hammer drilling</p>  <p>Diamond drilled holes^{c)}</p>  <p>Hilti SafeSet technology</p>	 <p>European Technical Assessment</p>  <p>CE conformity</p>  <p>PROFIS Rebar design Software</p>

^{c)}Diamond drilling only with Roughening Tool (RT)

Approvals / certificates		
Description	Authority / Laboratory	No. / date of issue
European technical Assessment ^{a)}	DIBt, Berlin	ETA-19/0600 / 2019-12-10 (HY200-R V3)

^{a)} All data given in this section according to ETA-19/0600, issue 2019-12-10.

Essential characteristics for rebar under tension load in concrete

Rebar			φ8	φ10	φ12	φ14	φ16	φ20	φ25	φ26	φ28	φ30	φ32
Diameter of rebar	φ	[mm]	8	10	12	14	16	20	25	26	28	30	32
Pull-out resistance													
Characteristic bond resistance in uncracked concrete C20/25													
Temperature range I: 40°C/24°C	$T_{Rk,ucr}$	[N/mm ²]	12										
Temperature range II: 80°C/50°C	$T_{Rk,ucr}$	[N/mm ²]	10										
Temperature range II: 80°C/50°C	$T_{Rk,ucr}$	[N/mm ²]	8,5										
Influence of cracked concrete	Ω_{cr}	[-]	0,53	0,58			0,61	0,64			0,73		
Installation safety factor													
Hammer drilling	γ_{inst}	[-]	1,0										
Hammer drilling with Hilti hollow drill bit TE-CD or TE-YD	γ_{inst}	[-]	1,0										
Diamond coring with roughening with Hilti roughening tool TE-YRT	γ_{inst}	[-]	-				1,0						
Bond-splitting resistance													
Product basic factor	A_k	[-]	4,1										
Exponent for influence of concrete compressive strength	sp1	[-]	0,31										
Exponent for influence of rebar diameter φ	sp2	[-]	0,32										
Exponent for influence of concrete cover c_d	sp3	[-]	0,67										
Exponent for influence of side concrete cover (c_{max} / c_d)	sp4	[-]	0,25										
Exponent for influence of anchorage length l_b	lb1	[-]	0,45										
Influence factors Ψ on bond resistance T_{Rk}													
Cracked and uncracked concrete: Factor for concrete strength	Ψ_c	C30/37	1,04										
		C40/45	1,07										
		C50/60	1,10										
Cracked and uncracked concrete: Sustained load factor	Ψ_{sus}^0	40°C/24°C	0,74										
		80°C/50°C	0,89										
		120°C/72°C	0,72										
Concrete cone failure													
Factor for uncracked concrete	$k_{ucr,N}$	[-]	11,0										
Factor for cracked concrete	$k_{cr,N}$	[-]	7,7										
Edge distance	$c_{cr,N}$	[mm]	$1,5 \cdot l_b$										
Spacing	$s_{cr,N}$	[mm]	$3,0 \cdot l_b$										

Static and quasi-static loading

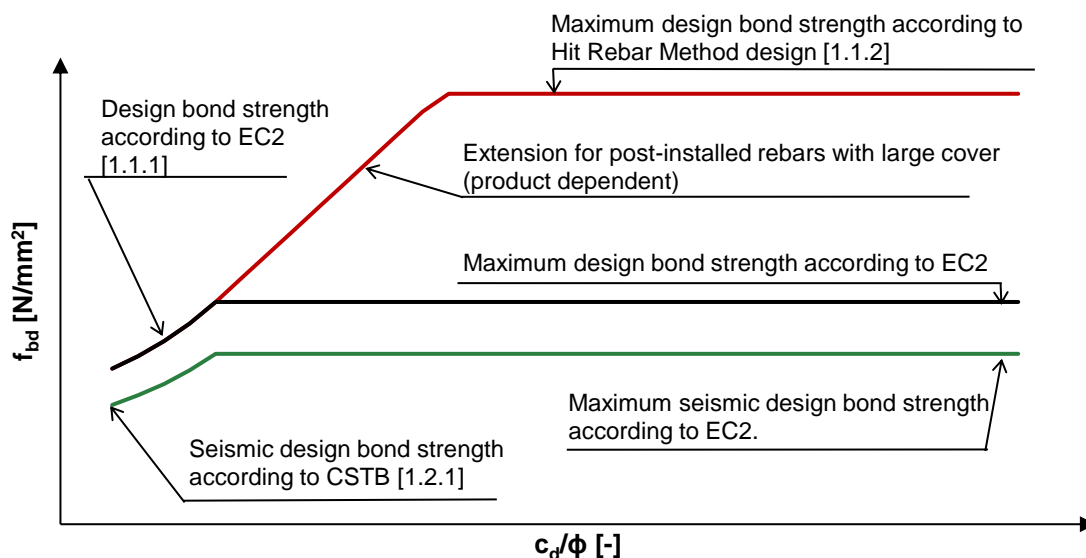

Effective limit on bond stress for post-installed rebar using Hilti mortar systems and design bond strength values as provided by the EC2.

Static EC2 design (small concrete cover)

Design bond strength in N/mm² for good bond conditions

All allowed drilling methods									
Rebar - size	Concrete class								
	C12/15	C16/20	C20/25	C25/30	C30/37	C35/45	C40/50	C45/55	C50/60
φ8 - φ32	1,6	2,0	2,3	2,7	3,0	3,4	3,7	4,0	4,3

For poor bond conditions multiply the values by 0,7. Values valid for uncracked and cracked concrete.

Static Hit Rebar Method design (large concrete cover)

Maximum design bond strength in N/mm² for good bond conditions

Non-cracked concrete, all allowed drilling methods								
Temperature range	Rebar - size	Concrete class						
		C20/25	C25/30	C30/37	C35/45	C40/45	C45/55	C50/60
I: 40°C/24°C	φ8 - φ32	8	8,2	8,3	8,4	8,6	8,7	8,8
II: 58°C/35°C		6,7	6,8	6,9	7,0	7,1	7,2	7,3
III: 70°C/43°C		5,7	5,8	5,9	6,0	6,1	6,1	6,2
Cracked concrete, all allowed drilling methods								
I: 40°C/24°C	φ12 - φ32	4,7	4,8	4,8	4,9	5,0	5,1	5,1
II: 58°C/35°C		3,7	3,7	3,8	3,9	3,9	4,0	4,0
III: 70°C/43°C		3,3	3,4	3,5	3,5	3,6	3,6	3,7

For poor bond conditions multiply the values by 0,7. *The reduction factor for rebar diameter equal to 10 mm is 0,72

Additional Hilti Technical Data:

Reduction factor for splitting with large concrete cover: $\delta = 0,306$ (Hilti additional data)

Minimum anchorage length and minimum lap length

The minimum anchorage length $\ell_{b,min}$ and the minimum lap length $\ell_{0,min}$ according to EN 1992-1-1 shall be multiplied by relevant **Amplification factor α_{lb}** in the table below.

Amplification factor α_{lb} for the min. anchorage length and min. lap length for
All allowed hammer drilling methods

Rebar - size	Concrete class								
	C12/15	C16/20	C20/25	C25/30	C30/37	C35/45	C40/50	C45/55	C50/60
$\phi 8 - \phi 32$	1,0								

Anchorage length for characteristic steel strength $f_{yk}=500 \text{ N/mm}^2$ for good conditions
All allowed drilling methods

Rebar-size	Concrete class	Yielding load [kN]	$l_{b,min}^{1)}$ [mm]	$l_{0,min}^{1)}$ [mm]	$l_{bd,y}^{2)}$ ($\alpha 2=1$) [mm]	$l_{bd,y}^{3)}$ ($\alpha 2=0.7$) [mm]	$l_{bd,y,HRM}^{4)}$ ($\alpha 2<0.7$) [mm]	$l_{max}^{5)}$ $-10^{\circ}\text{C} \leq C_t \leq 0^{\circ}\text{C}$ [mm]	$l_{max}^{6)}$ $C_t > 0^{\circ}\text{C}$ [mm]
$\phi 8$	C20/25	21,9	113	200	378	265	109	700	1000
$\phi 8$	C50/60	21,9	100	200	202	142	99	700	1000
$\phi 10$	C20/25	34,1	142	200	473	331	136	700	1000
$\phi 10$	C50/60	34,1	100	200	253	177	124	700	1000
$\phi 12$	C20/25	49,2	170	200	567	397	163	700	1000
$\phi 12$	C50/60	49,2	120	200	303	212	148	700	1000
$\phi 14$	C20/25	66,9	198	210	662	463	190	700	1000
$\phi 14$	C50/60	66,9	140	210	354	248	173	700	1000
$\phi 16$	C20/25	87,4	227	240	756	529	217	700	1000
$\phi 16$	C50/60	87,4	160	240	404	283	198	700	1000
$\phi 18$	C20/25	110,6	255	270	851	595	245	700	1000
$\phi 18$	C50/60	110,6	180	270	455	319	222	700	1000
$\phi 20$	C20/25	136,6	284	300	945	662	272	700	1000
$\phi 20$	C50/60	136,6	200	300	506	354	247	700	1000
$\phi 22$	C20/25	165,3	312	330	1040	728	299	700	1000
$\phi 22$	C50/60	165,3	220	330	556	389	272	700	1000
$\phi 24$	C20/25	196,7	340	360	1134	794	326	700	1000
$\phi 24$	C50/60	196,7	240	360	607	425	296	700	1000
$\phi 25$	C20/25	213,4	354	375	1181	827	340	700	1000
$\phi 25$	C50/60	213,4	250	375	632	442	309	700	1000
$\phi 26$	C20/25	230,8	369	390	1229	860	353	700	1000
$\phi 26$	C50/60	230,8	260	390	657	460	321	700	1000
$\phi 28$	C20/25	267,7	397	420	1323	926	380	700	1000
$\phi 28$	C50/60	267,7	280	420	708	495	346	700	1000
$\phi 30$	C20/25	307,3	425	450	1418	992	408	700	1000
$\phi 30$	C50/60	307,3	300	450	758	531	371	700	1000
$\phi 32$	C20/25	349,7	454	480	1512	1059	435	700	1000
$\phi 32$	C50/60	349,7	320	480	809	566	395	700	1000

- 1) According to EC2: EN 1992-1-1:2004 $l_{b,min}$ (8.6) and $l_{0,min}$ (8.11) are calculated for good bond conditions with characteristic yield strength $f_{yk} = 500 \text{ N/mm}^2$, $\gamma_M=1,15$ and $\alpha_6 = 1,0$
- 2) Embedment depth for yield of the rebar and for $c_d/\phi = 1$ (characteristic yield strength $f_{yk} = 500 \text{ N/mm}^2$)
- 3) Embedment depth for yield of the rebar and for $c_d/\phi = 3$ (characteristic yield strength $f_{yk} = 500 \text{ N/mm}^2$)
- 4) Embedment depth according to Hit Rebar design for yield of the rebar and for $c_d/\phi > 8$ (Temperature range I, characteristic yield strength $f_{yk} = 500 \text{ N/mm}^2$)
- 5) characteristic yield strength $f_{yk} = 500 \text{ N/mm}^2$
- 6) c_t =concrete temperature

Seismic data
Seismic reduction factor $k_{b,seis}$ for hammer drilling (HD) and (HDB) and compressed air drilling (CA)

Rebar - size	Reduction factor $k_{b,seis}$								
	Concrete class								
	C16/20	C20/25	C25/30	C30/37	C35/45	C40/50	C45/55	C50/60	
$\phi 10 - \phi 18$	1,0				0,90	0,82	0,76	0,71	
$\phi 20 - \phi 30$	1,0						0,92	0,86	
$\phi 32$	1,0								

For poor bond conditions multiply the values 0,7.



Design values for the ultimate bond resistance $f_{bd,seis}$ ¹⁾ in N/mm² for seismic loading for hammer drilling (HD) and (HDB) and compressed air drilling (CA)

Rebar - size	Bond resistance $f_{bd,seis}$							
	Concrete class							
	C16/20	C20/25	C25/30	C30/37	C35/45	C40/50	C45/55	C50/60
$\phi 10 - \phi 18$	2,0	2,3	2,7	3,0				
$\phi 20 - \phi 30$	2,0	2,3	2,7	3,0	3,4	3,7		
$\phi 32$	2,0	2,3	2,7	3,0	3,4	3,7	4,0	4,3

¹⁾ According to EN 1992-1-1:2004 for good bond conditions. For all other bond conditions multiply the values by 0.7.

Materials

Material quality

Part	Material
Rebar EN 1992-1-1	Bars and de-coiled rods class B or C with f_{yk} and k according to NDP or NCL of EN 1992-1-1 $f_{uk} = f_{tk} = k \cdot f_{yk}$

Fitness for use

Some creep tests have been conducted in accordance with ETAG guideline 001 part 5 and TR 023 in the following conditions: **in dry environment at 50 °C during 90 days.**

These tests show an excellent behaviour of the post-installed connection made with HIT-HY 200: low displacements with long term stability, failure load after exposure above reference load.

Resistance to chemical substances

Chemical	Resistance	Chemical	Resistance
Air	+	Gasoline	+
Acetic acid 10%	+	Glycole	o
Acetone	o	Hydrogen peroxide 10%	o
Ammonia 5%	+	Lactic acid 10%	+
Benzyl alcohol	-	Machinery oil	+
Chloric acid 10%	o	Methylethylketon	o
Chlorinated lime 10%	+	Nitric acid 10%	o
Citric acid 10%	+	Phosphoric acid 10%	+
Concrete plasticizer	+	Potassium Hydroxide pH 13,2	+
De-icing salt (Calcium chloride)	+	Sea water	+
Demineralized water	+	Sewage sludge	+
Diesel fuel	+	Sodium carbonate 10%	+
Drilling dust suspension pH 13,2	+	Sodium hypochlorite 2%	+
Ethanol 96%	-	Sulfuric acid 10%	+
Ethylacetate	-	Sulfuric acid 30%	+
Formic acid 10%	+	Toluene	o
Formwork oil	+	Xylene	o

- + resistant
- o resistant in short term (max. 48h) contact
- not resistant

Electrical Conductivity

HIT-HY 200 in the hardened state **is not conductive electrically**. Its electric resistivity is $15,5 \cdot 10^9 \Omega \cdot \text{cm}$ (DIN IEC 93 – 12.93). It is adapted well to realize electrically insulating anchoring (ex: railway applications, subway)

Setting information

Installation temperature range

-10°C to +40°C

Service temperature range

Hilti HIT-HY 200 injection mortar may be applied in the temperature ranges given below. An elevated base material temperature may lead to a reduction of the design bond resistance.

Temperature range	Base material temperature	Maximum long term base material temperature	Maximum short term base material temperature
Temperature range I	-40 °C to +80 °C	+50 °C	+80 °C

Max short term base material temperature

Short-term elevated base material temperatures are those that occur over brief intervals, e.g. as a result of diurnal cycling.

Max long term base material temperature

Long-term elevated base material temperatures are roughly constant over significant periods of time.

Curing and working time

Temperature of the base material	HIT-HY 200-R V3	
	Maximum working time t_{work}	Minimum curing time t_{cure}
$-10^{\circ}\text{C} < T_{BM} \leq -5^{\circ}\text{C}$	3 h	20 h
$-4^{\circ}\text{C} < T_{BM} \leq 0^{\circ}\text{C}$	1,5 h	8 h
$1^{\circ}\text{C} < T_{BM} \leq 5^{\circ}\text{C}$	45 min	4 h
$6^{\circ}\text{C} < T_{BM} \leq 10^{\circ}\text{C}$	30 min	2,5 h
$11^{\circ}\text{C} < T_{BM} \leq 20^{\circ}\text{C}$	15 min	1,5 h
$21^{\circ}\text{C} < T_{BM} \leq 30^{\circ}\text{C}$	9 min	1 h
$31^{\circ}\text{C} < T_{BM} \leq 40^{\circ}\text{C}$	6 min	1 h

Setting information

Installation equipment

Rebar – size	$\phi 8 - \phi 16$	$\phi 18 - \phi 32$
Rotary hammer	TE 2 (-A)– TE 40(-A)	TE40 – TE80
Other tools	Blow out pump ($h_{ef} \leq 10 \cdot d$)	-
	Compressed air gun ^{a)} Set of cleaning brushes ^{b)} , dispenser, piston plug	

a) Compressed air gun with extension hose for all drill holes deeper than 250 mm (for $\phi 8$ to $\phi 12$) or deeper than $20 \cdot \phi$ (for $\phi > 12$ mm)

b) Automatic brushing with round brush for all drill holes deeper than 250 mm (for $\phi 8$ to $\phi 12$) or deeper than $20 \cdot \phi$ (for $\phi > 12$ mm)

Minimum concrete cover c_{min} of the post-installed rebar

Drilling method	Bar diameter [mm]	Minimum concrete cover c_{min} [mm]	
		Without drilling aid	With drilling aid
Hammer drilling (HD) and (HDB)	$\phi < 25$	$30 + 0,06 \cdot l_v \geq 2 \cdot \phi$	$30 + 0,02 \cdot l_v \geq 2 \cdot \phi$
	$\phi \geq 25$	$40 + 0,06 \cdot l_v \geq 2 \cdot \phi$	$40 + 0,02 \cdot l_v \geq 2 \cdot \phi$
Compressed air drilling (CA)	$\phi < 25$	$50 + 0,08 \cdot l_v$	$50 + 0,02 \cdot l_v$
	$\phi \geq 25$	$60 + 0,08 \cdot l_v \geq 2 \cdot \phi$	$60 + 0,02 \cdot l_v \geq 2 \cdot \phi$
Diamond coring with roughening with Hilti Roughening tool TE-YRT (RT)	$\phi < 25$	$30 + 0,06 \cdot l_v \geq 2 \cdot \phi$	$30 + 0,02 \cdot l_v \geq 2 \cdot \phi$
	$\phi \geq 25$	$40 + 0,06 \cdot l_v \geq 2 \cdot \phi$	$40 + 0,02 \cdot l_v \geq 2 \cdot \phi$

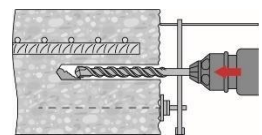

Drilling and cleaning diameters

Rebar [mm]	Hammer drill (HD)	Hollow Drill Bit (HDB) ^{b)}	Compressed air drill (CA)	Diamond coring with roughening tool (RT) ^{b)}	Brush HIT-RB	Air nozzle HIT-RB
	d ₀ [mm]				size [mm]	
φ8	12 / 10 ^{a)}	12	-	-	12 / 10 ^{a)}	12 / 10 ^{a)}
φ10	14 / 12 ^{a)}	14 / 12 ^{a)}	-	-	14 / 12 ^{a)}	14 / 12 ^{a)}
φ12	16 / 14 ^{a)}	16 / 14 ^{a)}	-	-	16 / 14 ^{a)}	16 / 14 ^{a)}
	-	-	17	-	18	16
φ14	18	18	17	18	18	18
φ16	20	20	-	-	20	20
	-	-	20	20	22	20
φ18	22	22	22	22	22	22
φ20	25	25	-	-	25	25
	-	-	26	25	28	25
φ22	28	28	28	28	28	28
φ24	32	32	32	32	32	32
φ25	32	32	32	32	32	
φ26	35	-	35	35	35	
φ28	35	-	35	35	35	
φ30	-	-	35	-	35	
	37	-	-	-	37	
φ32	40	-	40	-	40	

a) Both given values can be used / Maximum installation length l=250 mm.

Associated components for the use of Hilti Roughening tool TE-YRT

Diamond coring		Roughening tool TE-YRT	Wear gauge RTG...
d ₀ [mm]		d ₀ [mm]	size
Nominal	measured		
18	17,9 to 18,2	18	18
20	19,9 to 20,2	20	20
22	21,9 to 22,2	22	22
25	24,9 to 25,2	25	25
28	27,9 to 28,2	28	28
30	29,9 to 30,2	30	30
32	31,9 to 32,2	32	32
35	34,9 to 35,2	35	35

Installation parameters for use of the Hilti Roughening tool TE-YRT

h _{ef} [mm]	Minimum roughening time t _{roughen} [sec] (t _{roughen} [sec] = h _{ef} [mm] / 10)	Minimum blowing time t _{blowing} [sec] (t _{blowing} [sec] = t _{roughen} [sec] + 20)
0 to 100	10	30
101 to 200	20	40
201 to 300	30	50
301 to 400	40	60
401 to 500	50	70
501 to 600	60	80

Dispensers and corresponding maximum embedment depth $l_{v,max}$

Rebar	Dispenser	
	HDM 330, HDM 500	HDE 500
	Concrete temp. $\geq -10^{\circ}\text{C}$	Concrete temp. $\geq 0^{\circ}\text{C}$
	$l_{v,max}$ [mm]	$l_{v,max}$ [mm]
$\phi 8 - \phi 32$	700	1000

Setting instructions

*For detailed information on installation see instruction for use given with the package of the product.



Safety regulations.

Review the Material Safety Data Sheet (MSDS) before use for proper and safe handling! Wear well-fitting protective goggles and protective gloves when working with Hilti HIT-HY 200-R V3.

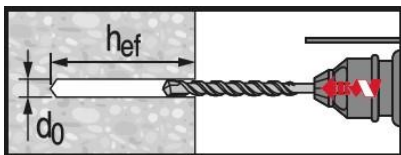

Hammer drilled hole (HD)

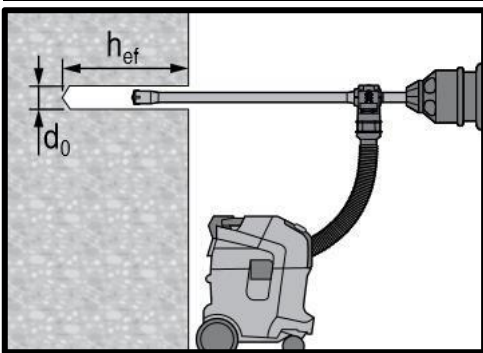

Hammer drilled hole with Hollow Drilled Bit (HDB)

No cleaning required

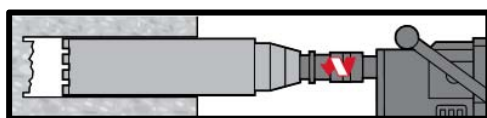

Diamond Drilling + Roughening Tool (DD+RT)

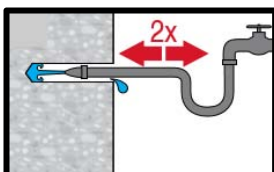
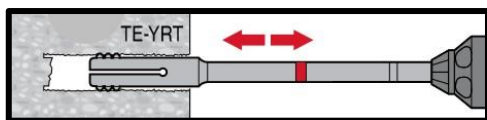

Flush 2 times by inserting a water hose (water-line pressure) to the back of the hole until water runs clear.

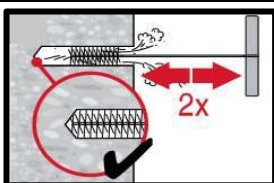

Brush 2 times with the specific brush by inserting the steel brush Hilti HIT-RB to the back of the hole in a twisting motion and removing it.

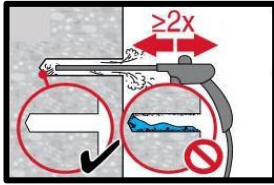

Blow 2 times from the back of the hole over the whole length with oil-free compressed air (min. 6 bar at 6 m³/h) until return air stream is free of noticeable dust and water. Remove all water from the drillhole until drillhole is completely dried before mortar injection.

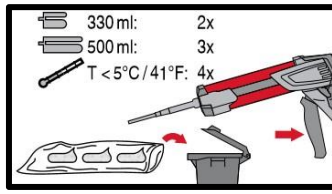
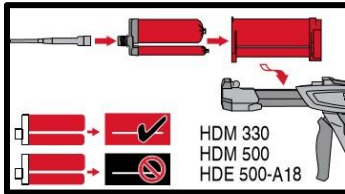

Injection system preparation.

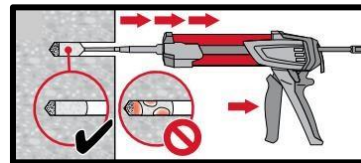
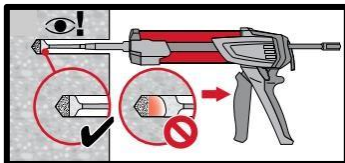

Injection method for drill hole depth
 $h_{ef} \leq 250 \text{ mm.}$

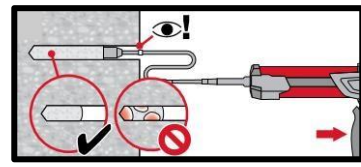
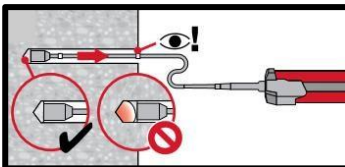

Injection method for drill hole depth
 $h_{ef} > 250 \text{ mm.}$

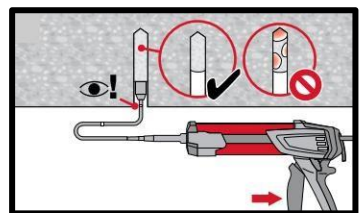
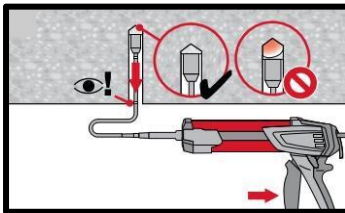

Injection method for overhead application.

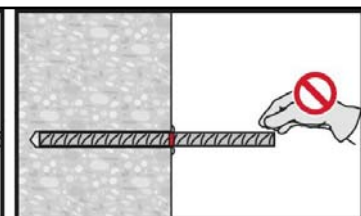
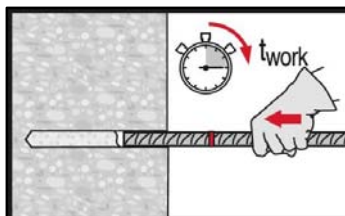

Setting element, observe working time
“ t_{work} ”.

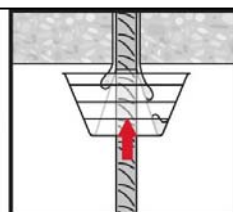
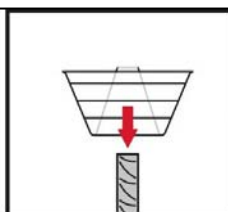
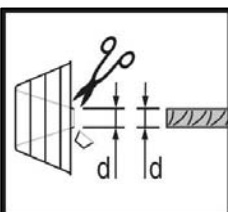

Setting element for overhead applications, observe working time
“ t_{work} ”.

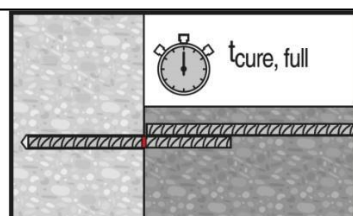
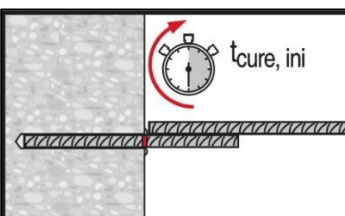
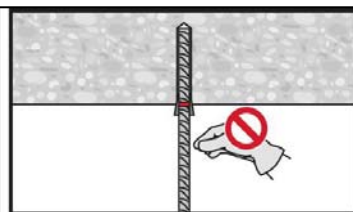
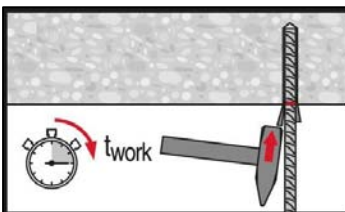

Apply full load only after curing time
“ t_{cure} ”.

