



# HILTI HST3 EXPANSION ANCHOR

ETA-98/0001 (13.07.2020)



[English](#) 2-64

[Deutsch](#) 66-128

[Polski](#) 130-194

Approval body for construction products  
and types of construction

Bautechnisches Prüfamt

An institution established by the Federal and  
Laender Governments



## European Technical Assessment

**ETA-98/0001**  
**of 13 July 2020**

English translation prepared by DIBt - Original version in German language

### General Part

Technical Assessment Body issuing the  
European Technical Assessment:

Deutsches Institut für Bautechnik

Trade name of the construction product

Hilti metal expansion anchor HST, HST-R, HST-HCR,  
HST3, HST3-R

Product family  
to which the construction product belongs

Mechanical fastener for use in concrete

Manufacturer

Hilti Aktiengesellschaft  
Business Unit Anchors  
9494 Schaan  
FÜRSTENTUM LIECHTENSTEIN

Manufacturing plant

Hilti Werke

This European Technical Assessment  
contains

63 pages including 3 annexes which form an integral part  
of this assessment

This European Technical Assessment is  
issued in accordance with Regulation (EU)  
No 305/2011, on the basis of

EAD 330232-01-0601 Edition 12/2019

This version replaces

ETA-98/0001 issued on 2 October 2019

The European Technical Assessment is issued by the Technical Assessment Body in its official language. Translations of this European Technical Assessment in other languages shall fully correspond to the original issued document and shall be identified as such.

Communication of this European Technical Assessment, including transmission by electronic means, shall be in full. However, partial reproduction may only be made with the written consent of the issuing Technical Assessment Body. Any partial reproduction shall be identified as such.

This European Technical Assessment may be withdrawn by the issuing Technical Assessment Body, in particular pursuant to information by the Commission in accordance with Article 25(3) of Regulation (EU) No 305/2011.

## Specific Part

### 1 Technical description of the product

The Hilti metal expansion anchor HST, HST-R, HST-HCR, HST3 and HST3-R is an anchor made of galvanized steel (HST, HST3), stainless steel (HST-R, HST3-R) or high corrosion resistant steel (HST-HCR) which is placed into a drilled hole and anchored by torque controlled expansion.

The product description is given in Annex A.

### 2 Specification of the intended use in accordance with the applicable European Assessment Document

The performances given in Section 3 are only valid if the anchor is used in compliance with the specifications and conditions given in Annex B.

The verifications and assessment methods on which this European Technical Assessment is based lead to the assumption of a working life of the anchor of at least 50 years. The indications given on the working life cannot be interpreted as a guarantee given by the producer, but are to be regarded only as a means for choosing the right products in relation to the expected economically reasonable working life of the works.

### 3 Performance of the product and references to the methods used for its assessment

#### 3.1 Mechanical resistance and stability (BWR 1)

Essential characteristic	Performance
Characteristic resistance to tension load (static and quasi-static loading) Method A	See Annex B8 to B13, C1 to C4
Characteristic resistance to shear load (static and quasi-static loading)	See Annex C5 to C8
Displacements and Durability	See Annex B1, C9 to C12
Characteristic resistance and displacements for seismic performance category C1 and C2	See Annex C13 to C23

#### 3.2 Safety in case of fire (BWR 2)

Essential characteristic	Performance
Reaction to fire	Class A1
Resistance to fire	See Annex C24 to C33



English translation prepared by DIBt

**4 Assessment and verification of constancy of performance (AVCP) system applied, with reference to its legal base**

In accordance with the European Assessment Document EAD 330232-01-0601 the applicable European legal act is: [96/582/EC].

The system to be applied is: 1

**5 Technical details necessary for the implementation of the AVCP system, as provided for in the applicable EAD**

Technical details necessary for the implementation of the AVCP system are laid down in the control plan deposited with Deutsches Institut für Bautechnik.

Issued in Berlin on 13 July 2020 by Deutsches Institut für Bautechnik

Dr.-Ing. Lars Eckfeldt  
p. p. Head of Department

*beglaubigt:*  
Lange

## Installed condition

**Figure A1:**

Hilti metal expansion anchor HST, HST-R and HST-HCR

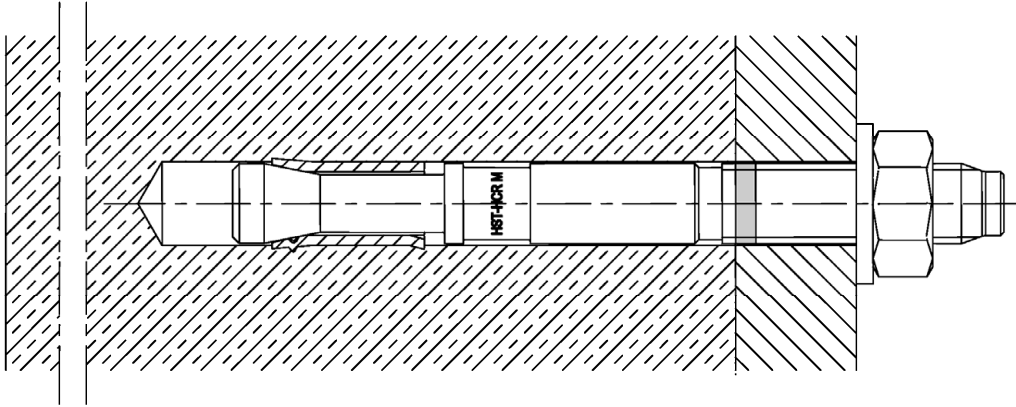

**Figure A2:**

Hilti metal expansion anchor HST3 and HST3-R with standard and shallow embedment depth

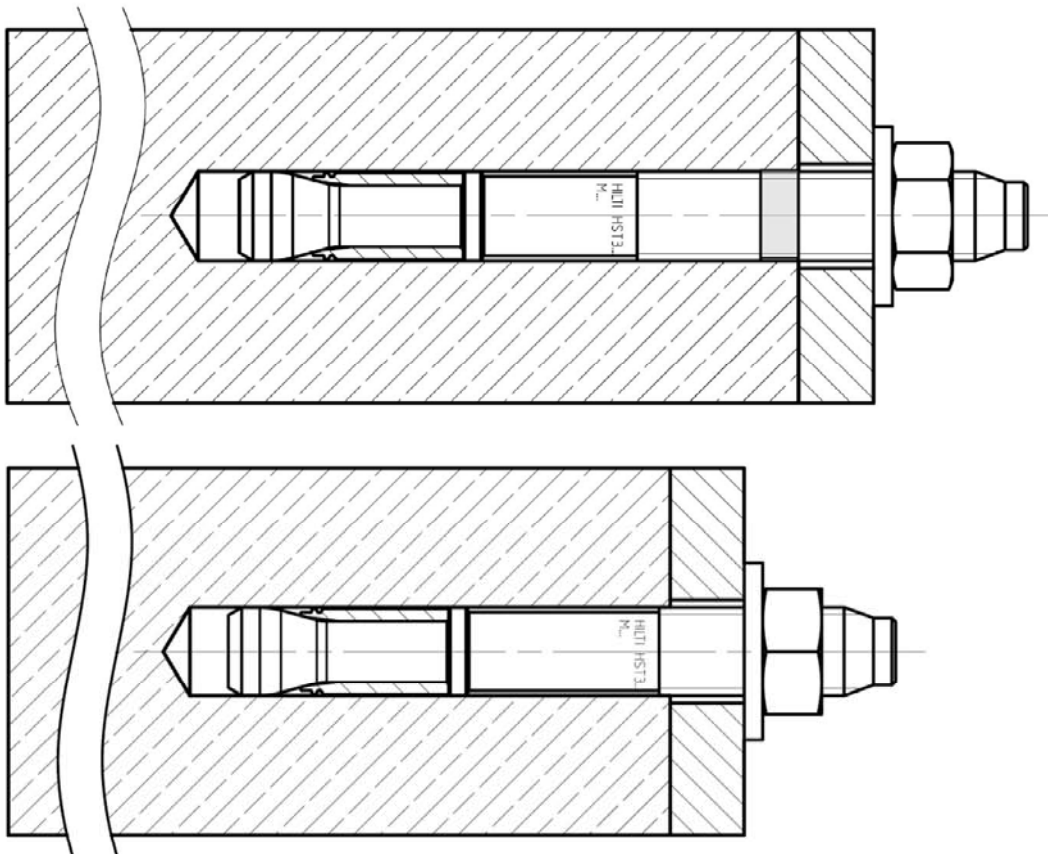

Hilti metal expansion anchor HST, HST-R, HST-HCR, HST3, HST3-R

**Product description**  
Installed condition

**Annex A1**

**Figure A3:**

Hilti metal expansion anchor HST3 and HST3-R with Filling Set

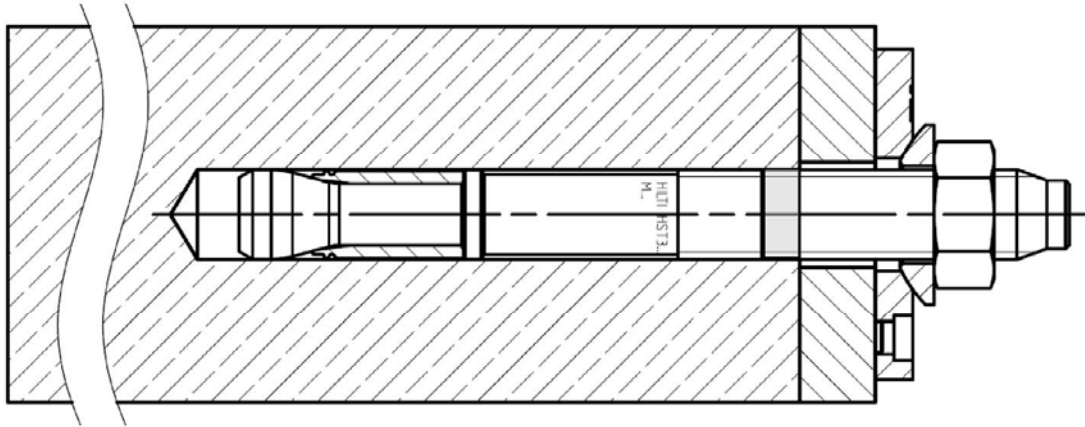

**Hilti metal expansion anchor HST, HST-R, HST-HCR, HST3, HST3-R**

**Product description**  
Installed condition

**Annex A2**

**Product description: Hilti metal expansion anchor HST, HST-R and HST-HCR**

**Cold-formed version**

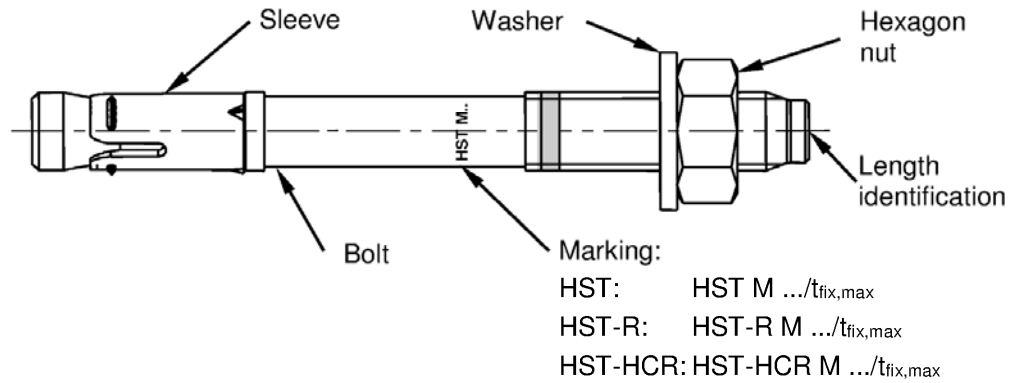

**Machined version**

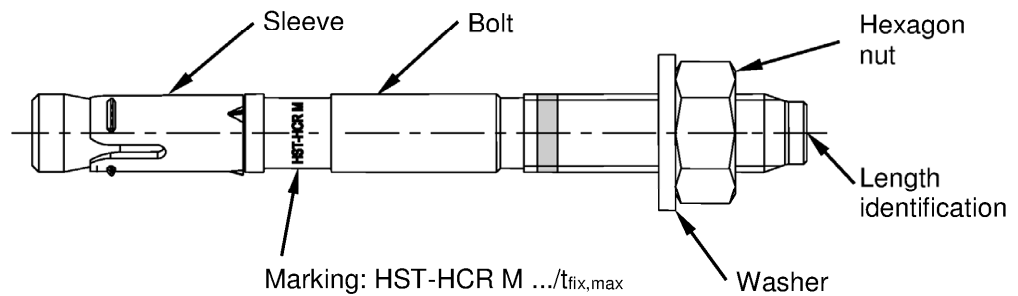

**Hilti metal expansion anchor HST, HST-R, HST-HCR, HST3, HST3-R**

**Product description**  
Anchor types, marking and identification

**Annex A3**

## Product description: Hilti metal expansion anchor HST3 and HST3-R

### Cold-formed version

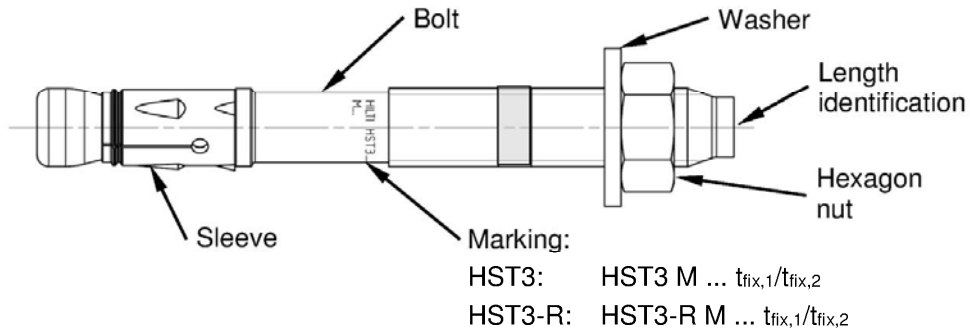

### Machined version M8 - M16

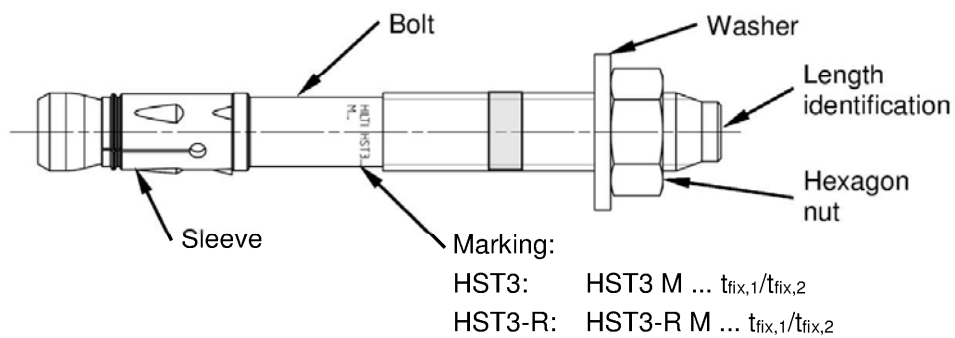

### Machined version M20 - M24

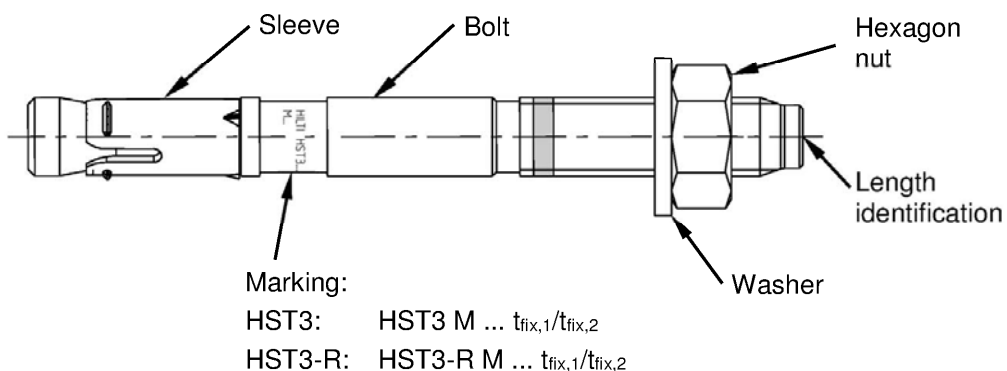

Hilti metal expansion anchor HST, HST-R, HST-HCR, HST3, HST3-R

Product description  
Anchor types, marking and identification

Annex A4

**Table A1: Length identification HST, HST3, HST-R, HST3-R, HST-HCR**

Letter		A	B	C	D	E	f	II
Anchor length	≥ [mm]	38,1	50,8	63,5	76,2	88,9	100,0	100,0
	< [mm]	50,8	63,5	76,2	88,9	101,6	100,0	100,0

Letter		F	G	Δ	H	I	J	K
Anchor length	≥ [mm]	101,6	114,3	125,0	127,0	139,7	152,4	165,1
	< [mm]	114,3	127,0	125,0	139,7	152,4	165,1	177,8

Letter		L	M	N	O	P	Q	R
Anchor length	≥ [mm]	177,8	190,5	203,2	215,9	228,6	241,3	254,0
	< [mm]	190,5	203,2	215,9	228,6	241,3	254,0	279,4

Letter		r	S	T	U	V	W	X
Anchor length	≥ [mm]	260,0	279,4	304,8	330,2	355,6	381,0	406,4
	< [mm]	260,0	304,8	330,2	355,6	381,0	406,4	431,8

Letter		Y	Z	AA	BB	CC	DD	EE
Anchor length	≥ [mm]	431,8	457,2	482,6	508,0	533,4	558,8	584,2
	< [mm]	457,2	482,6	508,0	533,4	558,8	584,2	609,6

Letter		FF	GG	HH	II	JJ	KK	LL
Anchor length	≥ [mm]	609,6	635,0	660,4	685,8	711,2	736,6	762,0
	< [mm]	635,0	660,4	685,8	711,2	736,6	762,0	787,4

Letter		MM	NN	OO	PP	QQ	RR	SS
Anchor length	≥ [mm]	787,4	812,8	838,2	863,6	889,0	914,4	939,8
	< [mm]	812,8	838,2	863,6	889,0	914,4	939,8	965,2

Letter		TT	UU	VV
Anchor length	≥ [mm]	965,2	990,6	1016,0
	< [mm]	990,6	1016,0	1041,4

**Hilti metal expansion anchor HST, HST-R, HST-HCR, HST3, HST3-R**

**Product description**  
Anchor types, marking and identification

**Annex A5**

**Table A2: Materials**

Designation	Material
<b>HST (Carbon steel)</b>	
Expansion sleeve	Stainless steel A4 according to EN 10088-1:2014
Bolt	Carbon steel, galvanized, coated (transparent), rupture elongation ( $l_0 = 5d$ ) > 8 %
Washer	Carbon steel, galvanized
Hexagon nut	Carbon steel, galvanized
<b>HST-R (Stainless steel)</b> <b>Corrosion resistance class III according EN 1993-1-4:2006+A1:2015</b>	
Expansion sleeve	Stainless steel A4 according to EN 10088-1:2014
Bolt	Stainless steel A4 according to EN 10088-1:2014, cone coated (red or transparent), rupture elongation ( $l_0 = 5d$ ) > 8 %
Washer	Stainless steel A4 according to DIN EN ISO 3506-1:2010
Hexagon nut	Stainless steel A4 according to DIN EN ISO 3506-2:2010, coated
<b>HST-HCR (High corrosion resistance steel)</b> <b>Corrosion resistance class V according EN 1993-1-4:2006+A1:2015</b>	
Expansion sleeve	Stainless steel A4 according to EN 10088-1:2014
Bolt	High corrosion resistance steel according to EN 10088-1:2014, cone coated (red), rupture elongation ( $l_0 = 5d$ ) > 8 %
Washer	High corrosion resistance steel according to EN 10088-1:2014
Hexagon nut	High corrosion resistance steel according to EN 10088-1:2014, coated

Hilti metal expansion anchor HST, HST-R, HST-HCR, HST3, HST3-R

Product description  
Materials

**Annex A6**

**Table A2 continued**

Designation	Material
<b>HST3 (Carbon steel)</b>	
Expansion sleeve	M10, M16: Carbon steel, galvanized or stainless steel according to EN 10088-1:2014 M8, M12, M20, M24: Stainless steel according to EN 10088-1:2014
Bolt	Carbon steel, galvanized, coated (transparent), rupture elongation ( $l_0 = 5d$ ) > 8 %
Washer	Carbon steel, galvanized
Hexagon nut	Carbon steel, galvanized
<b>Filling Set (Carbon steel)</b>	
Sealing washer	Carbon steel, galvanized
Spherical washer	Carbon steel, galvanized
<b>HST3-R (Stainless steel)</b> <b>Corrosion resistance class III according EN 1993-1-4:2006+A1:2015</b>	
Expansion sleeve	Stainless steel A4 according to EN 10088-1:2014
Bolt	Stainless steel A4 according to EN 10088-1:2014, cone coated (transparent), rupture elongation ( $l_0 = 5d$ ) > 8 %
Washer	Stainless steel A4 according to DIN EN ISO 3506-1:2010
Hexagon nut	Stainless steel A4 according to DIN EN ISO 3506-2:2010, coated
<b>Filling Set (Stainless steel)</b> <b>Corrosion resistance class III according EN 1993-1-4:2006+A1:2015</b>	
Sealing washer	Stainless steel A4 according to ASTM A 240/A 240M:2019
Spherical washer	Stainless steel A4 according to EN 10088-1:2014

**Hilti metal expansion anchor HST, HST-R, HST-HCR, HST3, HST3-R**

**Product description**  
Materials

**Annex A7**



### Injection mortar Hilti HIT-HY 200-A

Hybrid system with resin, hardener, cement and water  
Foil pack 330 ml and 500 ml

Marking:  
HILTI HIT  
Production number and  
production line  
Expiry date mm/yyyy



Product name: "Hilti HIT-HY 200-A"

### Static mixer Hilti HIT-RE-M



### Dispensers



Hilti HDM 330



Hilti HDE 500

**Table A3: curing time Hilti HIT-HY 200-A**

Temperature of base material / environment	Curing time $t_{\text{cure}}$ Hilti HIT-HY 200-A
-10 °C to -5 °C	7 hours
-4 °C to 0 °C	4 hours
1 °C to 5 °C	2 hours
6 °C to 10 °C	75 minutes
11 °C to 20 °C	45 minutes
21 °C to 30 °C	30 minutes
31 °C to 40 °C	30 minutes

**Hilti metal expansion anchor HST, HST-R, HST-HCR, HST3, HST3-R**

**Product description**  
Injection mortar

**Annex A8**

**Table A4: Dimensions HST, HST-R and HST-HCR**

HST, HST-R, HST-HCR			M8	M10	M12	M16	M20 <sup>1)</sup>	M24 <sup>1)</sup>
Maximum length of anchor	$l_{\max} \leq$	[mm]	260	280	295	350	450	500
Shaft diameter at the cone	$d_R$	[mm]	5,5	7,2	8,5	11,6	14,6	17,4
Length of expansion sleeve	$l_S$	[mm]	14,8	18,2	22,7	24,3	28,3	36,0

<sup>1)</sup> Only HST and HST-R

**HST, HST-R and HST-HCR**

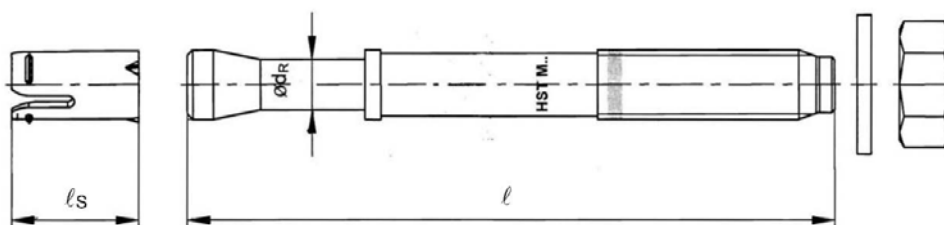

**Table A5: Dimensions HST3 and HST3-R**

HST3, HST3-R			M8	M10	M12	M16	M20	M24
Maximum length of anchor	$l_{\max} \leq$	[mm]	260	280	350	475	450	500
Shaft diameter at the cone	$d_R$	[mm]	5,60	6,94	8,22	11,00	14,62	17,4
Length of expansion sleeve	$l_S$	[mm]	13,6	16,0	20,0	25,0	28,3	36,0
Diameter of washer	$d_w \geq$	[mm]	15,57	19,48	23,48	29,48	36,38	43,38

**HST3 and HST3-R**

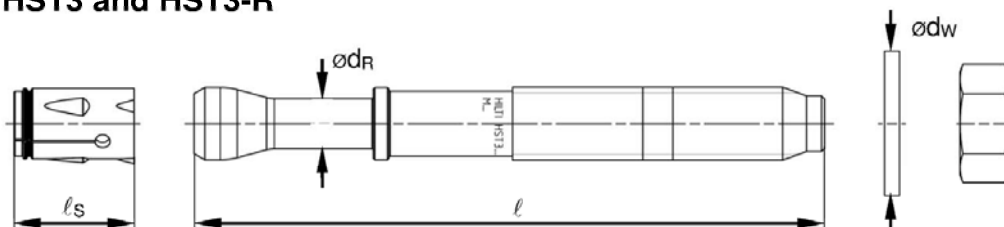

**Hilti metal expansion anchor HST, HST-R, HST-HCR, HST3, HST3-R**

**Product description**  
Dimensions

**Annex A9**

## Filling Set to fill the annular gap between anchor and fixture

**Table A6: Dimensions Filling Set**

Filling Set used for HST3, HST3-R			M8	M10	M12	M16	M20
Diameter of sealing washer	d <sub>vs</sub>	[mm]	38	42	44	52	60
Thickness of sealing washer	h <sub>vs</sub>	[mm]	5			6	

Sealing washer

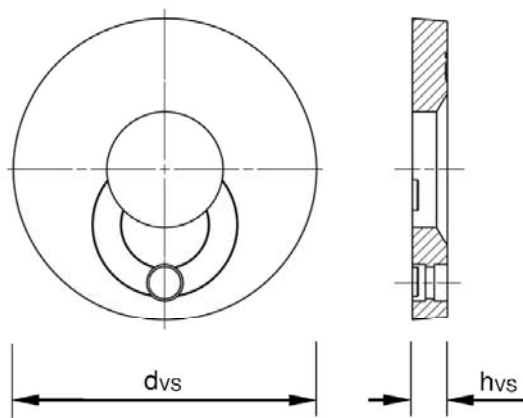

Spherical washer

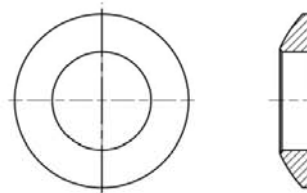

Hilti metal expansion anchor HST, HST-R, HST-HCR, HST3, HST3-R

Product description  
Dimensions

Annex A10

## Specifications of intended use

### Base materials:

- Compacted reinforced or unreinforced normal weight concrete without fibres according to EN 206-1:2013 + A1:2016.
- Strength classes C20/25 to C50/60 according to EN 206-1:2013 + A1:2016.
- Cracked and non-cracked concrete

### Use conditions (Environmental conditions):

- Structures subject to dry internal conditions (all materials)
- For all other conditions according EN 1993-1-4:2006 + A1:2015 corresponding to corrosion resistance classes Annex A6 Table A1 (stainless steels).

### Design:

- Anchorages are designed under the responsibility of an engineer experienced in anchorages and concrete work.
- Verifiable calculation notes and drawings are prepared taking account of the loads to be anchored. The position of the anchor is indicated on the design drawings (e. g. position of the anchor relative to reinforcement or to supports, etc.).
- Anchorages are designed in accordance with:  
EN 1992-4:2018 and EOTA Technical Report TR 055, 12/2016
- In case of requirements to resistance to fire local spalling of the concrete cover must be avoided.

Hilti metal expansion anchor HST, HST-R, HST-HCR, HST3, HST3-R

Specifications of intended use

Annex B1

**Installation:**



- Anchor installation carried out by appropriately qualified personnel and under the supervision of the person responsible for technical matters of the site.
- The anchor may only be set once.
- Overhead applications are permitted.

**Table B1: Drilling technique HST, HST-R and HST-HCR**



HST, HST-R and HST-HCR	M8	M10	M12	M16	M20 <sup>1)</sup>	M24 <sup>1)</sup>
Hammer drilling (HD) 	✓	✓	✓	✓	✓	✓

<sup>1)</sup> Only HST and HST-R

**Table B2: Drilling technique HST3 and HST3-R**

HST3, HST3-R	M8	M10	M12	M16	M20	M24
Hammer drilling (HD) 	✓	✓	✓	✓	✓	✓
Diamond coring (DD) with <ul style="list-style-type: none"> <li>• DD EC-1 coring tool and DD-C ... TS/TL core bits or DD-C ... T2/T4 core bits </li> <li>• DD 30-W coring tool and C+ ... SPX-T (abrasive) core bits</li> </ul>	✓	✓	✓	✓	✓	✓
Hammer drilling with Hilti hollow drill bit TE-CD/YD ... drilling system (HDB) 	-	-	✓	✓	✓	✓

**Table B3: Drill hole cleaning**

<b>Manual cleaning (MC):</b> Hilti hand pump for blowing out boreholes 	
<b>Compressed air cleaning (CAC):</b> Air nozzle with an orifice opening of 3,5 mm in diameter 	
<b>Automated cleaning (AC):</b> Cleaning is performed during drilling with Hilti TE-CD and TE-YD drilling system including vacuum cleaner 	

Hilti metal expansion anchor HST, HST-R, HST-HCR, HST3, HST3-R

Specifications of intended use



Annex B2

**Table B4: Methods for application of torque moment HST, HST-R and HST-HCR**

HST, HST-R and HST-HCR	M8	M10	M12	M16	M20 <sup>1)</sup>	M24 <sup>1)</sup>
Torque wrench 	✓	✓	✓	✓	✓	✓

<sup>1)</sup> Only HST and HST-R

**Table B5: Methods for application of torque moment HST3 and HST3-R**

HST3, HST3-R	M8	M10	M12	M16	M20	M24
Torque wrench 	✓	✓	✓	✓	✓	✓
Machine torquing with Hilti SIW 6AT-A22 impact wrench and SI-AT-A22 adaptive torque module 	✓	✓	✓	-	-	-

**Table B6: Overview use and performance categories HST, HST-R and HST-HCR**

Anchorage subject to:	HST, HST-R, HST-HCR
Static and quasi static loading	M8 to M24 (HST and HST-R) M8 to M16 (HST-HCR) Table : C1, C3, C5
Seismic performance category C1/C2	M10 to M16 (HST and HST-R) Table : C7, C9, C11, C12, C15, C16
Static and quasi static loading under fire exposure	M8 to M24 Table : C19, C21

**Table B7: Overview use and performance categories HST3 and HST3-R**

Anchorage subject to:	HST3, HST3-R
Static and quasi static loading	M10 to M16 (for $h_{ef,1}$ ) M8 to M24 (for $h_{ef,2}$ ) Table : C2, C4, C6
Seismic performance category C1/C2	M8 to M20 (for $h_{ef,2}$ ) M12 (for $h_{ef,1}$ ) Table : C8, C10, C13, C14, C17, C18
Static and quasi static loading under fire exposure	M10 to M16 (for $h_{ef,1}$ ) M8 to M24 (for $h_{ef,2}$ ) Table : C20, C22

Hilti metal expansion anchor HST, HST-R, HST-HCR, HST3, HST3-R

Specifications of intended use

Annex B3

**Table B8: Installation parameters for HST, HST-R and HST-HCR**

HST, HST-R, HST-HCR			M8	M10	M12	M16	M20 <sup>1)</sup>	M24 <sup>1)</sup>
Nominal diameter of drill bit	$d_0$	[mm]	8	10	12	16	20	24
Cutting diameter of drill bit	$d_{cut} \leq$	[mm]	8,45	10,45	12,50	16,50	20,55	24,55
Drill hole depth	$h_1 \geq$	[mm]	65	80	95	115	140	170
Effective embedment depth	$h_{ef}$	[mm]	47	60	70	82	101	125
Thread engagement length	$h_{nom}$	[mm]	55	69	80	95	117	143
Maximum diameter of clearance hole in the fixture <sup>2)</sup>	$d_f$	[mm]	9	12	14	18	22	26
Installation torque moment	$T_{inst}$	[Nm]	20	45	60	110	240	300
Maximum thickness of fixture	$t_{fix,max} \leq$	[mm]	195	200	200	235	305	330
Width across flats	SW	[mm]	13	17	19	24	30	36

<sup>1)</sup> Only HST and HST-R

<sup>2)</sup> For the design of bigger clearance holes in the fixture see EN 1992-4:2018.

**Hilti metal expansion anchor HST, HST-R, HST-HCR, HST3, HST3-R**

**Intended use**  
Installation parameters

**Annex B4**

**Table B9: Installation parameters for HST3 and HST3-R**

HST3, HST3-R			M8	M10	M12	M16	M20	M24
Nominal diameter of drill bit	$d_0$	[mm]	8	10	12	16	20	24
Cutting diameter of drill bit for hammer drilling	$d_{cut} \leq$	[mm]	8,45	10,45	12,50	16,50	20,55	24,55
Drill hole depth <sup>1)</sup>	$h_{1,1} \geq$	[mm]	-	53	68	86	-	-
Effective embedment depth	$h_{ef,1}$	[mm]	-	40	50	65	-	-
Thread engagement length	$h_{nom,1}$	[mm]	-	48	60	78	-	-
Drill hole depth <sup>1)</sup>	$h_{1,2} \geq$	[mm]	59	73	88	106	124	151
Effective embedment depth	$h_{ef,2}$	[mm]	47	60	70	85	101	125
Thread engagement length	$h_{nom,2}$	[mm]	54	68	80	98	116	143
Maximum diameter of clearance hole in the fixture <sup>2)</sup>	$d_f$	[mm]	9	12	14	18	22	26
Installation torque moment	$T_{inst}$	[Nm]	20	45	60	110	180	300
Maximum thickness of fixture	$t_{fix,max}$	[mm]	195	220	270	370	310	330
Width across flats	SW	[mm]	13	17	19	24	30	36

<sup>1)</sup> In case of diamond drilling + 5 mm for M8 to M10 and + 2 mm for M12 to M24

<sup>2)</sup> For the design of bigger clearance holes in the fixture see EN 1992-4:2018.

**Hilti metal expansion anchor HST, HST-R, HST-HCR, HST3, HST3-R**

**Intended use**  
Installation parameters

**Annex B5**



### HST, HST-R and HST-HCR

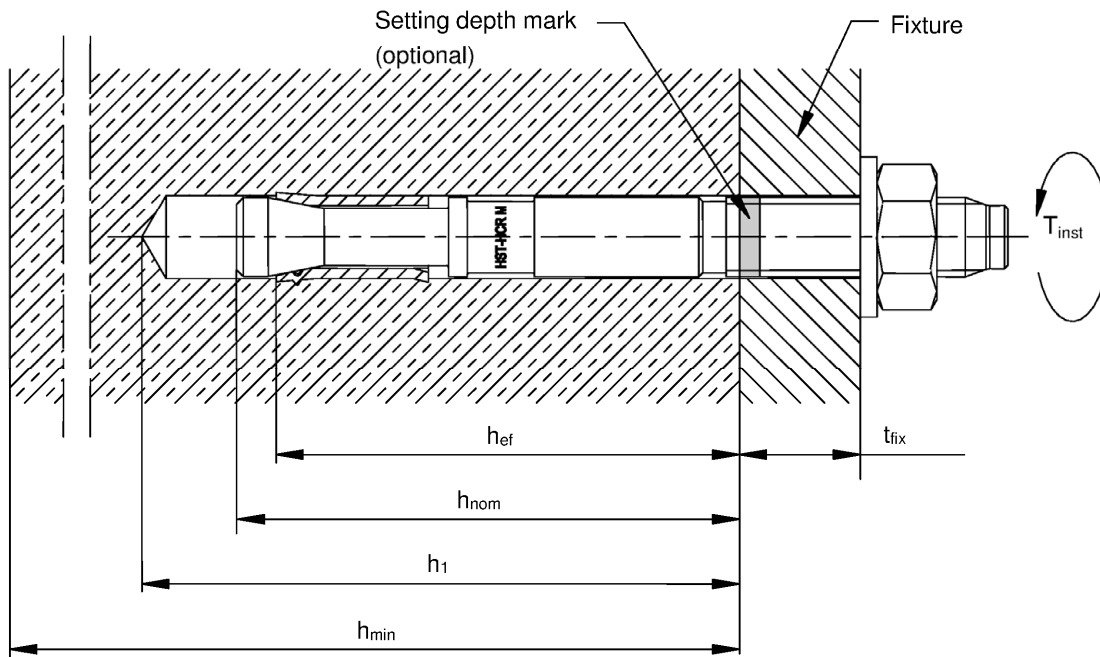

### HST3 and HST3-R (standard embedment depth)

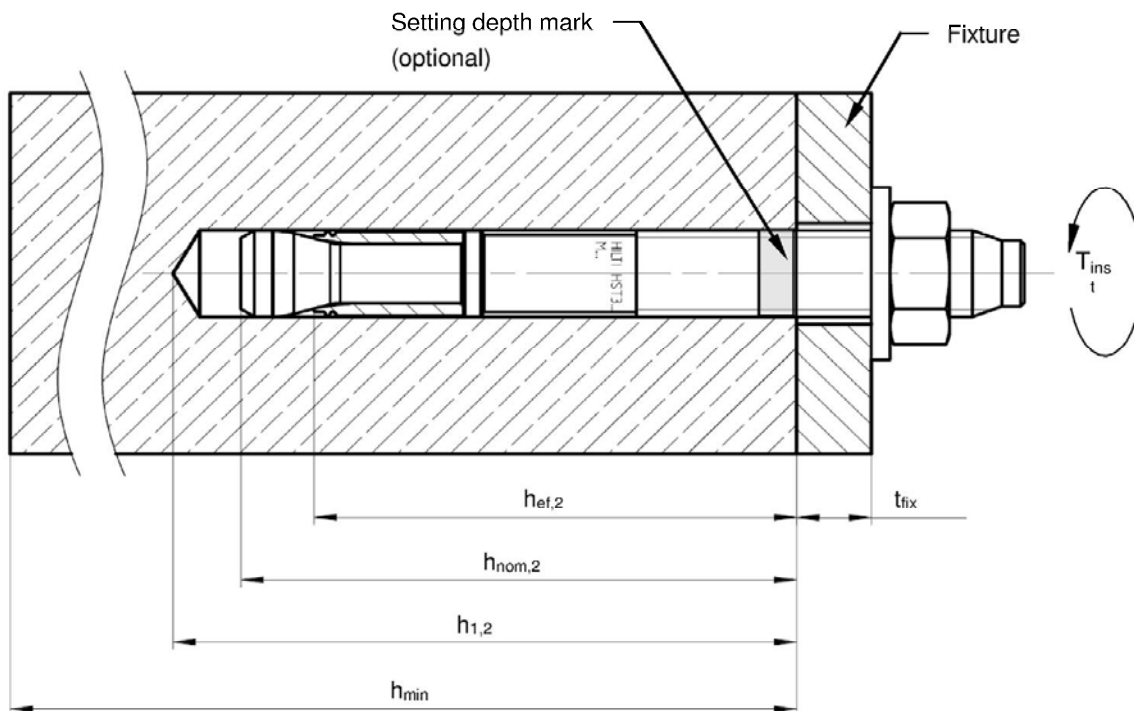

Hilti metal expansion anchor HST, HST-R, HST-HCR, HST3, HST3-R

Intended Use  
Installation parameters

Annex B6

### HST3 and HST3-R (shallow embedment depth)

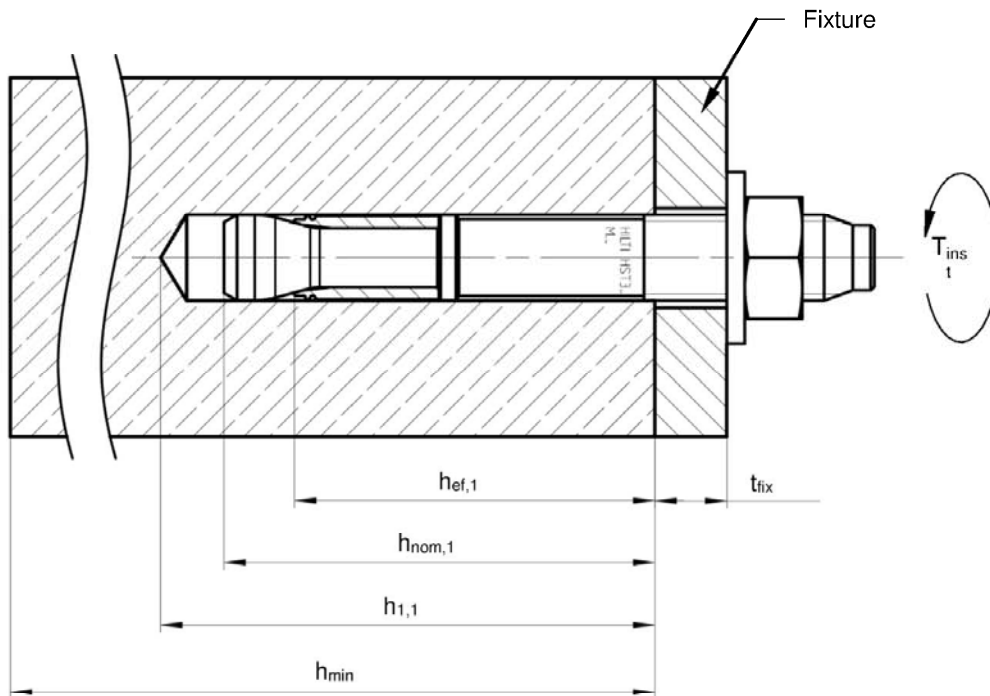

### HST3 and HST3-R with Filling Set to fill the annular gap between anchor and fixture

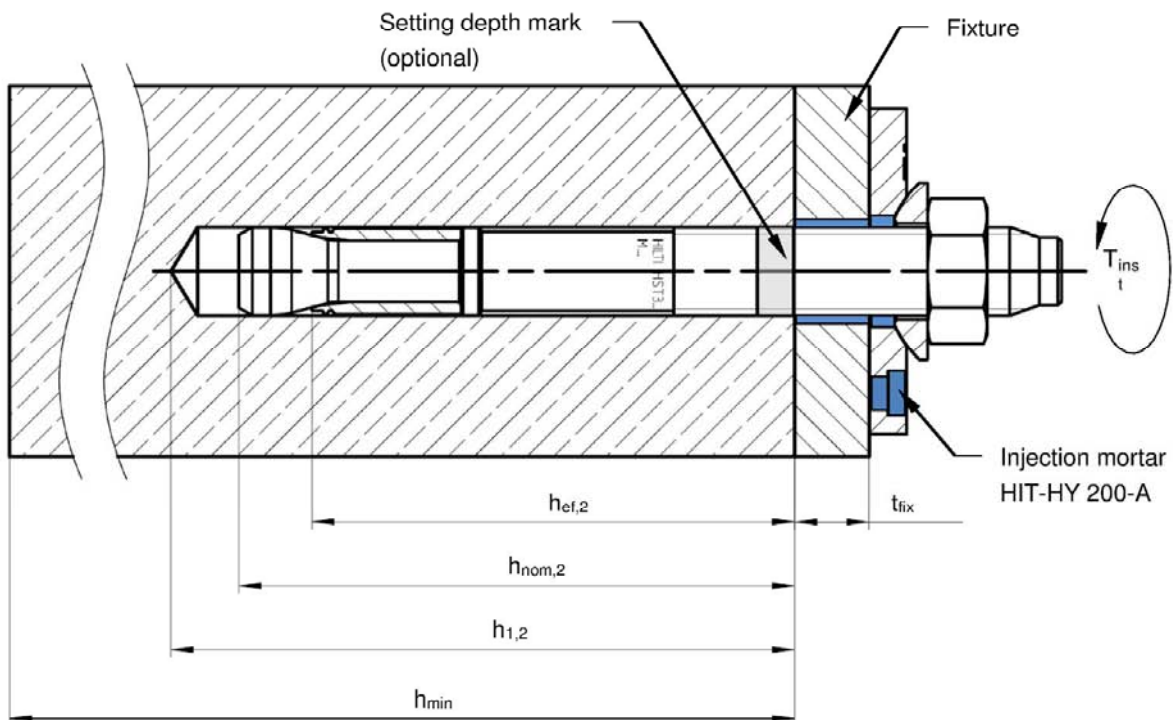

**Hilti metal expansion anchor HST, HST-R, HST-HCR, HST3, HST3-R**

**Intended Use**  
Installation parameters

**Annex B7**

**Table B10: Minimum spacing and edge distance for HST, HST-R and HST-HCR**

		M8	M10	M12	M16	M20 <sup>1)</sup>	M24 <sup>1)</sup>
Minimum thickness of concrete member	$h_{min}$ [mm]	100	120	140	160	200	250
Effective embedment depth	$h_{ef}$ [mm]	47	60	70	82	101	125
<b>Cracked concrete</b>							
<b>HST</b>							
Minimum spacing <sup>2)</sup>	$s_{min}$ [mm]	40	55	60	70	100	125
	for $c \geq$ [mm]	50	70	75	100	160	180
Minimum edge distance <sup>2)</sup>	$c_{min}$ [mm]	45	55	55	70	100	125
	for $s \geq$ [mm]	50	90	120	150	225	240
<b>HST-R</b>							
Minimum spacing <sup>2)</sup>	$s_{min}$ [mm]	40	55	60	70	100	125
	for $c \geq$ [mm]	50	65	75	100	130	130
Minimum edge distance <sup>2)</sup>	$c_{min}$ [mm]	45	50	55	60	100	125
	for $s \geq$ [mm]	50	90	110	160	160	140
<b>HST-HCR</b>							
Minimum spacing <sup>2)</sup>	$s_{min}$ [mm]	40	55	60	70	<sup>3)</sup>	<sup>3)</sup>
	for $c \geq$ [mm]	50	70	75	100	<sup>3)</sup>	<sup>3)</sup>
Minimum edge distance <sup>2)</sup>	$c_{min}$ [mm]	45	50	55	60	<sup>3)</sup>	<sup>3)</sup>
	for $s \geq$ [mm]	50	90	110	160	<sup>3)</sup>	<sup>3)</sup>

<sup>1)</sup> Only HST and HST-R

<sup>2)</sup> Linear interpolation for  $s_{min}$  and  $c_{min}$  allowed

<sup>3)</sup> No performance assessed

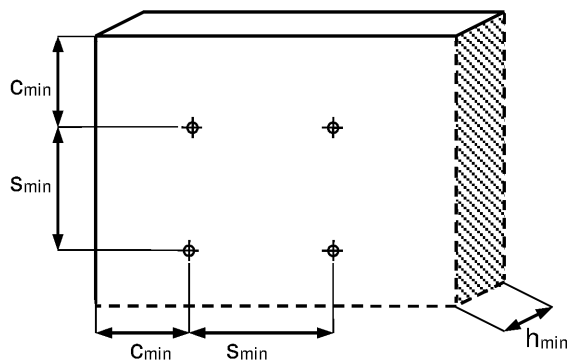

**Hilti metal expansion anchor HST, HST-R, HST-HCR, HST3, HST3-R**

**Intended Use**  
Minimum spacing and minimum edge distance

**Annex B8**

**Table B10 continued**

		M8	M10	M12	M16	M20 <sup>1)</sup>	M24 <sup>1)</sup>
Minimum thickness of concrete member	$h_{min}$ [mm]	100	120	140	160	200	250
Effective embedment depth	$h_{ef}$ [mm]	47	60	70	82	101	125
<b>Non-cracked concrete</b>							
<b>HST</b>							
Minimum spacing <sup>2)</sup>	$s_{min}$ [mm]	60	55	60	70	100	125
	for $c \geq$ [mm]	50	80	85	110	225	255
Minimum edge distance <sup>2)</sup>	$c_{min}$ [mm]	50	55	55	85	140	170
	for $s \geq$ [mm]	60	115	145	150	270	295
<b>HST-R</b>							
Minimum spacing <sup>2)</sup>	$s_{min}$ [mm]	60	55	60	70	100	125
	for $c \geq$ [mm]	60	70	80	110	195	205
Minimum edge distance <sup>2)</sup>	$c_{min}$ [mm]	60	50	55	70	140	150
	for $s \geq$ [mm]	60	115	145	160	210	235
<b>HST-HCR</b>							
Minimum spacing <sup>2)</sup>	$s_{min}$ [mm]	60	55	60	70	<sup>3)</sup>	<sup>3)</sup>
	for $c \geq$ [mm]	50	70	80	110	<sup>3)</sup>	<sup>3)</sup>
Minimum edge distance <sup>2)</sup>	$c_{min}$ [mm]	60	55	55	70	<sup>3)</sup>	<sup>3)</sup>
	for $s \geq$ [mm]	60	115	145	160	<sup>3)</sup>	<sup>3)</sup>

<sup>1)</sup> Only HST and HST-R

<sup>2)</sup> Linear interpolation for  $s_{min}$  and  $c_{min}$  allowed

<sup>3)</sup> No performance assessed

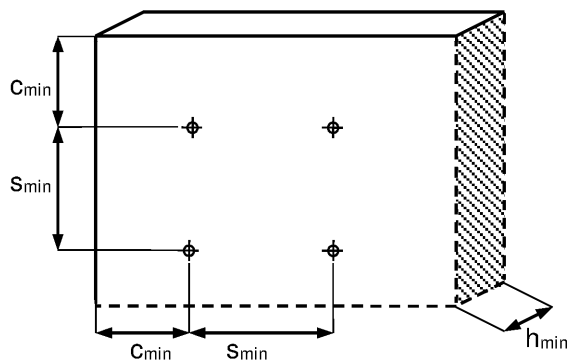

**Hilti metal expansion anchor HST, HST-R, HST-HCR, HST3, HST3-R**

**Intended Use**  
Minimum spacing and minimum edge distance

**Annex B9**

**Table B11: Minimum spacing and edge distance for HST3 and HST3-R**

		M8	M10	M12	M16	M20	M24
Minimum thickness of concrete member	$h_{min}$ [mm]	100	120	140	160	200	250
Effective embedment depth	$h_{ef,2}$ [mm]	47	60	70	85	101	125
<b>Cracked concrete</b>							
<b>HST3</b>							
Minimum spacing <sup>1)</sup>	$s_{min}$ [mm]	35	40	50	65	90	125
	for $c \geq$ [mm]	50	55	70	95	130	180
Minimum edge distance <sup>1)</sup>	$c_{min}$ [mm]	40	45	55	65	80	125
	for $s \geq$ [mm]	50	80	110	150	180	240
<b>HST3-R</b>							
Minimum spacing <sup>1)</sup>	$s_{min}$ [mm]	35	40	50	65	90	125
	for $c \geq$ [mm]	50	55	70	95	130	130
Minimum edge distance <sup>1)</sup>	$c_{min}$ [mm]	40	45	55	65	80	125
	for $s \geq$ [mm]	50	80	110	150	180	140

<sup>1)</sup> Linear interpolation for  $s_{min}$  and  $c_{min}$  allowed

<sup>2)</sup> No performance assessed

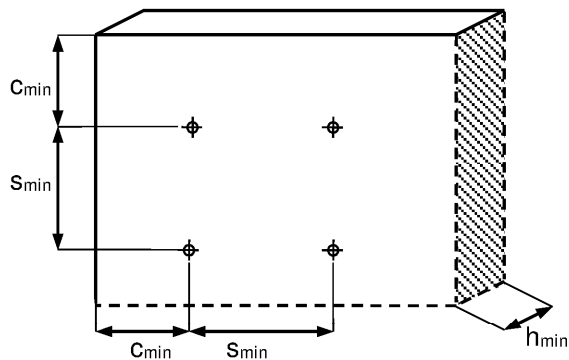

**Hilti metal expansion anchor HST, HST-R, HST-HCR, HST3, HST3-R**

**Intended Use**  
Minimum spacing and minimum edge distance

**Annex B10**

**Table B11 continued**

		M8	M10	M12	M16	M20	M24
Minimum thickness of concrete member	$h_{min}$ [mm]	100	120	140	160	200	250
Effective embedment depth	$h_{ef,2}$ [mm]	47	60	70	85	101	125
<b>Non-cracked concrete</b>							
<b>HST3</b>							
Minimum spacing <sup>1)</sup>	$s_{min}$ [mm]	35	40	60	65	90	125
	for $c \geq$ [mm]	50	60	70	95	130	255
Minimum edge distance <sup>1)</sup>	$c_{min}$ [mm]	40	50	55	65	80	170
	for $s \geq$ [mm]	50	90	110	150	180	295
<b>HST3-R</b>							
Minimum spacing <sup>1)</sup>	$s_{min}$ [mm]	35	40	60	65	90	125
	for $c \geq$ [mm]	50	60	70	95	130	205
Minimum edge distance <sup>1)</sup>	$c_{min}$ [mm]	40	50	55	65	80	150
	for $s \geq$ [mm]	50	90	110	150	180	235

<sup>1)</sup> Linear interpolation for  $s_{min}$  and  $c_{min}$  allowed

<sup>2)</sup> No performance assessed

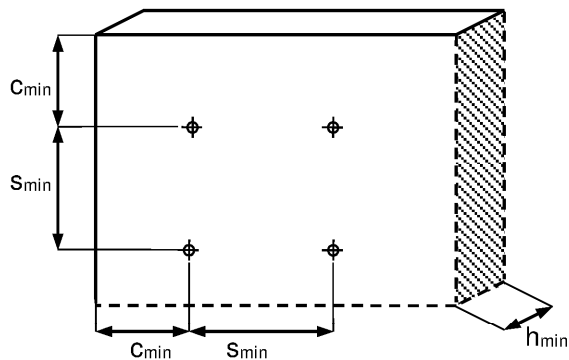

**Hilti metal expansion anchor HST, HST-R, HST-HCR, HST3, HST3-R**

**Intended Use**  
Minimum spacing and minimum edge distance

**Annex B11**

**Table B11 continued**

		M8	M10	M12	M16	M20	M24
Minimum thickness of concrete member	$h_{min}$ [mm]	80	100	120	140	160	2)
Effective embedment depth	$h_{ef,2}$ [mm]	47	60	70	85	101	2)
<b>Cracked concrete</b>							
<b>HST3 and HST3-R</b>							
Minimum spacing <sup>1)</sup>	$s_{min}$ [mm]	35	40	50	80	120	2)
	for $c \geq$ [mm]	50	100	90	130	180	2)
Minimum edge distance <sup>1)</sup>	$c_{min}$ [mm]	40	60	60	65	120	2)
	for $s \geq$ [mm]	50	90	120	180	180	2)
<b>Non-cracked concrete</b>							
<b>HST3 and HST3-R</b>							
Minimum spacing <sup>1)</sup>	$s_{min}$ [mm]	35	40	50	80	120	2)
	for $c \geq$ [mm]	55	100	100	130	180	2)
Minimum edge distance <sup>1)</sup>	$c_{min}$ [mm]	40	60	60	65	120	2)
	for $s \geq$ [mm]	60	90	120	180	180	2)

<sup>1)</sup> Linear interpolation for  $s_{min}$  and  $c_{min}$  allowed

<sup>2)</sup> No performance assessed

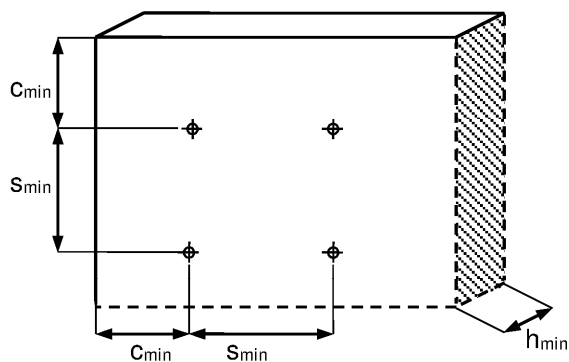

**Hilti metal expansion anchor HST, HST-R, HST-HCR, HST3, HST3-R**

**Intended Use**  
Minimum spacing and minimum edge distance

**Annex B12**

**Table B11 continued**

		M8	M10	M12	M16	M20	M24
Minimum thickness of concrete member	$h_{min}$ [mm]	2)	80	100	120	2)	2)
Effective embedment depth	$h_{ef,1}$ [mm]	2)	40	50	65	2)	2)
<b>Cracked concrete</b>							
<b>HST3 and HST3-R</b>							
Minimum spacing <sup>1)</sup>	$s_{min}$ [mm]	2)	40	50	65	2)	2)
	for $c \geq$ [mm]	2)	90	105	130	2)	2)
Minimum edge distance <sup>1)</sup>	$c_{min}$ [mm]	2)	45	55	65	2)	2)
	for $s \geq$ [mm]	2)	180	210	240	2)	2)
<b>Non-cracked concrete</b>							
<b>HST3 and HST3-R</b>							
Minimum spacing <sup>1)</sup>	$s_{min}$ [mm]	2)	50	55	75	2)	2)
	for $c \geq$ [mm]	2)	95	110	140	2)	2)
Minimum edge distance <sup>1)</sup>	$c_{min}$ [mm]	2)	50	60	65	2)	2)
	for $s \geq$ [mm]	2)	190	215	240	2)	2)

<sup>1)</sup> Linear interpolation for  $s_{min}$  and  $c_{min}$  allowed

<sup>2)</sup> No performance assessed

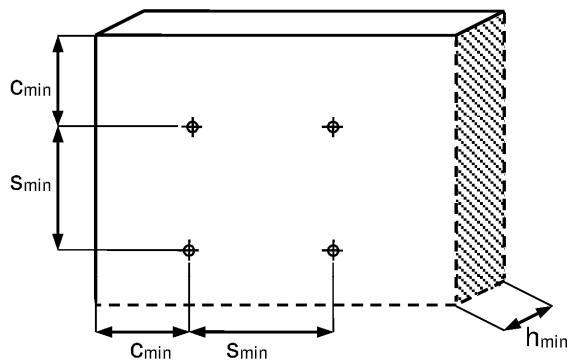

**Hilti metal expansion anchor HST, HST-R, HST-HCR, HST3, HST3-R**

**Intended Use**  
Minimum spacing and minimum edge distance

**Annex B13**



## Installation instruction HST, HST-R and HST-HCR

### Hole drilling and cleaning

- a) Hammer drilling (HD):  
M8 to M24

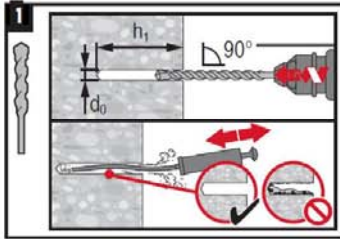

### Anchor setting

- a) Hammer setting:  
M8 to M24



- b) Machine setting (setting tool):  
M8 to M24

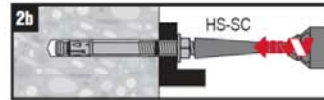

### Check setting

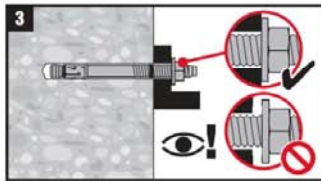

### Anchor torquing

- a) Torque wrench:  
M8 to M24

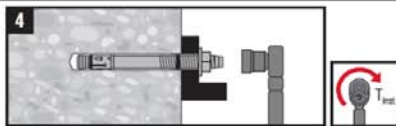

Hilti metal expansion anchor HST, HST-R, HST-HCR, HST3, HST3-R

Intended Use  
Installation instructions

Annex B14

## Installation instruction HST3 and HST3-R

### Hole drilling and cleaning

a) Hammer drilling (HD):  
M8 to M24

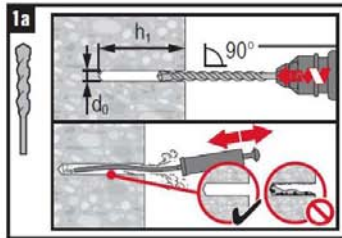

b) Diamond coring (DD):  
M8 to M24

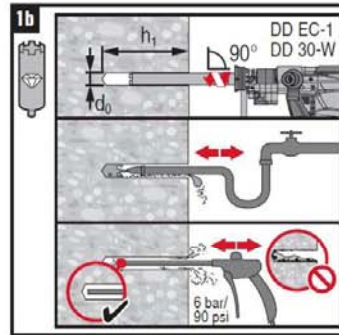

c) Hammer drilling with Hilti hollow drill bit (HDB):  
M12 to M24

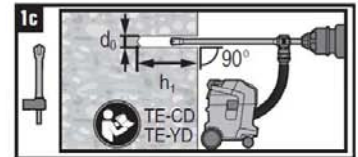

### Anchor setting

a) Hammer setting:



b) Machine setting (setting tool):

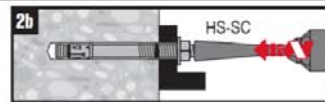

### Check setting

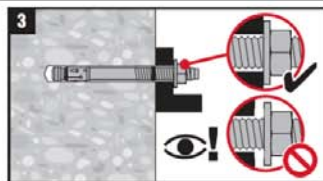

### Anchor torquing

a) Torque wrench:  
M8 to M24

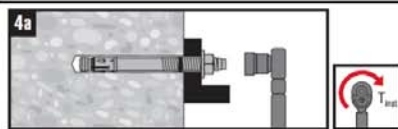

b) Machine torquing:  
M8 to M12

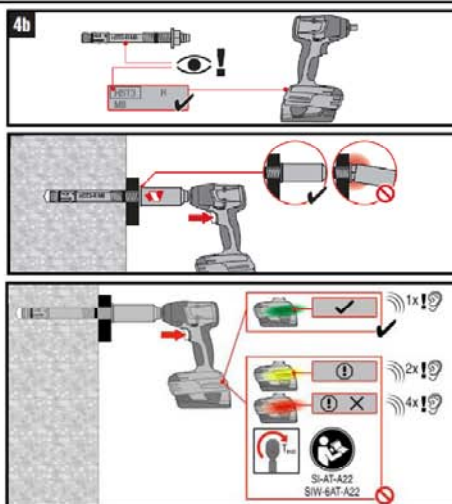

Hilti metal expansion anchor HST, HST-R, HST-HCR, HST3, HST3-R

Intended Use  
Installation instructions

Annex B15

## Installation instruction HST3 and HST3-R with Filling Set

### Installation of sealing washer

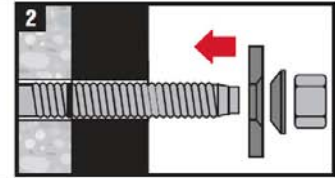
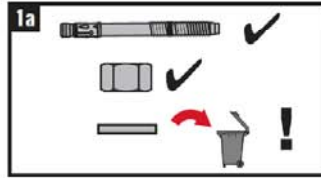
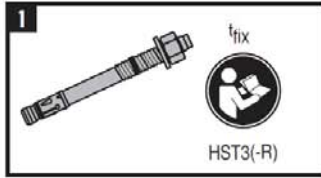

### Anchor torquing

a) Torque wrench:  
M8 to M20

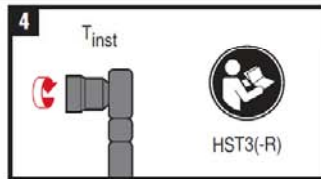
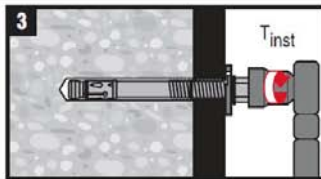

### Installation of counter nut

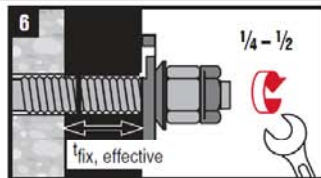
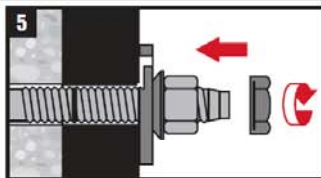

### Injection of mortar

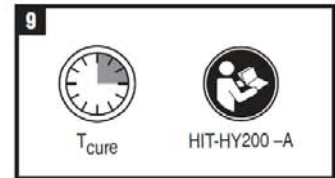
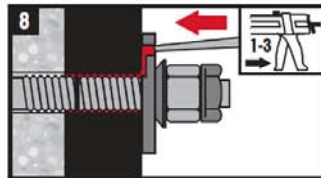

Hilti metal expansion anchor HST, HST-R, HST-HCR, HST3, HST3-R

Intended Use  
Installation instructions

Annex B16

**Table C1: Characteristic tension resistance for Hilti metal expansion anchor HST, HST-R and HST-HCR in cracked and non-cracked concrete**

			M8	M10	M12	M16	M20 <sup>1)</sup>	M24 <sup>1)</sup>	
<b>Steel failure</b>									
<b>HST</b>									
Characteristic resistance	$N_{Rk,s}$	[kN]	19,0	32,0	45,0	76,0	117,0	127,0	
Partial safety factor	$\gamma_{Ms}$ <sup>2)</sup>	[-]	1,50					1,41	
<b>HST-R</b>									
Characteristic resistance	$N_{Rk,s}$	[kN]	17,0	28,0	40,0	69,0	109,0	156,0	
Partial safety factor	$\gamma_{Ms}$ <sup>2)</sup>	[-]	1,50			1,56	1,73		
<b>HST-HCR</b>									
Characteristic resistance	$N_{Rk,s}$	[kN]	19,4	32,3	45,7	84,5	<sup>3)</sup>	<sup>3)</sup>	
Partial safety factor	$\gamma_{Ms}$ <sup>2)</sup>	[-]	1,50				<sup>3)</sup>	<sup>3)</sup>	
<b>Pullout failure</b>									
<b>HST</b>									
Characteristic resistance in cracked concrete C20/25	$N_{Rk,p}$	[kN]	5,0	9,0	12,0	20,0	30,0	40,0	
Characteristic resistance in non-cracked concrete C20/25	$N_{Rk,p}$	[kN]	9,0	16,0	20,0	35,0	50,0	60,0	
Installation safety factor	$\gamma_{inst}$	[-]	1,20	1,00					
<b>HST-R</b>									
Characteristic resistance in cracked concrete C20/25	$N_{Rk,p}$	[kN]	5,0	9,0	12,0	25,0	30,0	40,0	
Characteristic resistance in non-cracked concrete C20/25	$N_{Rk,p}$	[kN]	9,0	16,0	20,0	35,0	50,0	60,0	
Installation safety factor	$\gamma_{inst}$	[-]	1,00						
<b>HST-HCR</b>									
Characteristic resistance in cracked concrete C20/25	$N_{Rk,p}$	[kN]	5,0	9,0	12,0	25,0	<sup>3)</sup>	<sup>3)</sup>	
Characteristic resistance in non-cracked concrete C20/25	$N_{Rk,p}$	[kN]	9,0	16,0	20,0	35,0	<sup>3)</sup>	<sup>3)</sup>	
Installation safety factor	$\gamma_{inst}$	[-]	1,00				<sup>3)</sup>	<sup>3)</sup>	

<sup>1)</sup> Only HST and HST-R

<sup>2)</sup> In absence of other national regulations

<sup>3)</sup> No performance assessed

**Hilti metal expansion anchor HST, HST-R, HST-HCR, HST3, HST3-R**

**Performances**

Characteristic values of resistance under tension loading in cracked and non-cracked concrete

**Annex C1**

**Table C1 continued**

			M8	M10	M12	M16	M20 <sup>1)</sup>	M24 <sup>1)</sup>
<b>Pullout failure</b>								
<b>HST, HST-R and HST-HCR</b>								
Increasing factor for cracked and non-cracked concrete	$\psi_c$	C20/25	1,00					
	$\psi_c$	C30/37	1,22					
	$\psi_c$	C40/50	1,41					
	$\psi_c$	C50/60	1,55					
<b>Concrete cone and splitting failure</b>								
<b>HST, HST-R and HST-HCR</b>								
Effective embedment depth	$h_{ef}$	[mm]	47	60	70	82	101	125
Installation safety factor	$\gamma_{inst}$	[-]	1,20	1,00				
Factor for cracked concrete	$k_{cr,N}$	[-]	7,7					
Factor for non-cracked concrete	$k_{ucr,N}$	[-]	11,0					
Characteristic resistance in non-cracked concrete C20/25	$N^0_{Rk,sp}$	[kN]	9,0	16,0	20,0	35,0	50,0	60,0
Spacing	$s_{cr,N}$ $s_{cr,sp}$	[mm]	3 $h_{ef}$					
Edge distance	$c_{cr,N}$ $c_{cr,sp}$	[mm]	1,5 $h_{ef}$					

<sup>1)</sup> Only HST and HST-R

<sup>2)</sup> Sofern andere nationale Regelungen fehlen

<sup>3)</sup> Leistung nicht bewertet

**Hilti metal expansion anchor HST, HST-R, HST-HCR, HST3, HST3-R**

**Performances**

Characteristic values of resistance under tension loading in cracked and non-cracked concrete

**Annex C2**

**Table C2: Characteristic tension resistance for Hilti metal expansion anchor HST3 and HST3-R in cracked and non-cracked concrete**

			M8	M10	M12	M16	M20	M24
<b>Steel failure</b>								
<b>HST3</b>								
Characteristic resistance	$N_{Rk,s}$	[kN]	19,7	32,5	45,1	76,0	124,2	127,0
Partial safety factor	$\gamma_{Ms}^{1)}$	[-]	1,40					1,41
<b>HST3-R</b>								
Characteristic resistance	$N_{Rk,s}$	[kN]	17,7	28,7	42,5	69,4	115,8	156,0
Partial safety factor	$\gamma_{Ms}^{1)}$	[-]	1,40					1,56
<b>Pullout failure</b>								
<b>HST3</b>								
Effective embedment depth	$h_{ef,2}$	[mm]	47	60	70	85	101	125
Characteristic resistance in cracked concrete C20/25	$N_{Rk,p}$	[kN]	8,0	15,0	20,0	27,0	35,0	40,0
Characteristic resistance in non-cracked concrete C20/25	$N_{Rk,p}$	[kN]	12,0	22,0	25,0	38,6	49,9	60,0
Installation safety factor	$\gamma_{inst}$	[-]	1,00					
<b>HST3-R</b>								
Effective embedment depth	$h_{ef,2}$	[mm]	47	60	70	85	101	125
Characteristic resistance in cracked concrete C20/25	$N_{Rk,p}$	[kN]	8,5	15,0	20,0	27,0	35,0	40,0
Characteristic resistance in non-cracked concrete C20/25	$N_{Rk,p}$	[kN]	12,0	22,0	25,0	38,6	49,9	60,0
Installation safety factor	$\gamma_{inst}$	[-]	1,00					
<b>HST3 and HST3-R</b>								
Effective embedment depth	$h_{ef,1}$	[mm]	2)	40	50	65	2)	2)
Characteristic resistance in cracked concrete C20/25	$N_{Rk,p}$	[kN]	2)	8,7	12,2	18,0	2)	2)
Characteristic resistance in non-cracked concrete C20/25	$N_{Rk,p}$	[kN]	2)	12,4	17,4	25,8	2)	2)
Installation safety factor	$\gamma_{inst}$	[-]	1,00					

1) In absence of other national regulations

2) No performance assessed

**Hilti metal expansion anchor HST, HST-R, HST-HCR, HST3, HST3-R**

**Performances**

Characteristic values of resistance under tension loading in cracked and non-cracked concrete

**Annex C3**

**Table C2 continued**

			M8	M10	M12	M16	M20	M24
<b>Pullout Failure</b>								
<b>HST3 und HST3-R</b>								
Increasing factor for cracked and non-cracked concrete	$\psi_c$	C20/25	1,00					
	$\psi_c$	C30/37	1,22					
	$\psi_c$	C40/50	1,41					
	$\psi_c$	C50/60	1,55					
<b>Concrete cone and splitting failure</b>								
<b>HST3 und HST3-R</b>								
Effective embedment depth	$h_{ef,2}$	[mm]	47	60	70	85	101	125
Installation safety factor	$\gamma_{inst}$	[-]	1,00					
Factor for cracked concrete	$k_{cr,N}$	[-]	7,7					
Factor for non-cracked concrete	$k_{ucr,N}$	[-]	11,0					
Characteristic resistance in non-cracked concrete C20/25	$N^0_{RK,sp}$	[kN]	12,0	22,0	25,0	38,6	49,9	60,0
Spacing	$s_{cr,N}$	[mm]	3 $h_{ef}$					
Edge distance	$c_{cr,N}$	[mm]	1,5 $h_{ef}$					
Spacing	$s_{cr,sp}$	[mm]	3 $h_{ef}$				3,8 $h_{ef}$	3 $h_{ef}$
Edge distance	$c_{cr,sp}$	[mm]	1,5 $h_{ef}$				1,9 $h_{ef}$	1,5 $h_{ef}$
<b>HST3 und HST3-R</b>								
Effective embedment depth	$h_{ef,1}$	[mm]	2)	40	50	65	2)	2)
Installation safety factor	$\gamma_{inst}$	[-]	2)	1,00			2)	2)
Factor for cracked concrete	$k_{cr,N}$	[-]	2)	7,7			2)	2)
Factor for non-cracked concrete	$k_{ucr,N}$	[-]	2)	11,0			2)	2)
Characteristic resistance in non-cracked concrete C20/25	$N^0_{RK,sp}$	[kN]	2)	12,4	17,4	25,8	2)	2)
Spacing	$s_{cr,N}$	[mm]	2)	3 $h_{ef}$			2)	2)
Edge distance	$c_{cr,N}$	[mm]	2)	1,5 $h_{ef}$			2)	2)
Spacing	$s_{cr,sp}$	[mm]	2)	4,2 $h_{ef}$	3,6 $h_{ef}$	3,2 $h_{ef}$	2)	2)
Edge distance	$c_{cr,sp}$	[mm]	2)	2,1 $h_{ef}$	1,8 $h_{ef}$	1,6 $h_{ef}$	2)	2)

1) In absence of other national regulations

2) No performance assessed

**Hilti metal expansion anchor HST, HST-R, HST-HCR, HST3, HST3-R**

**Performances**

Characteristic values of resistance under tension loading in cracked and non-cracked concrete

**Annex C4**

**Table C3: Characteristic shear resistance for Hilti metal expansion anchor HST, HST-R and HST-HCR in cracked and non-cracked concrete**

			M8	M10	M12	M16	M20 <sup>1)</sup>	M24 <sup>1)</sup>	
<b>Steel failure, shear force without lever arm</b>									
<b>HST</b>									
Characteristic resistance	$V_{Rk,s}^0$	[kN]	14,0	23,5	35,0	55,0	84,0	94,0	
Partial safety factor	$\gamma_{Ms}^{2)}$	[-]	1,25					1,50	
Ductility factor	$k_7$	[-]	1,00						
<b>HST-R</b>									
Characteristic resistance	$V_{Rk,s}^0$	[kN]	13,0	20,0	30,0	50,0	80,0	115,0	
Partial safety factor	$\gamma_{Ms}^{2)}$	[-]	1,25			1,30	1,44		
Ductility factor	$k_7$	[-]	1,00						
<b>HST-HCR</b>									
Characteristic resistance	$V_{Rk,s}^0$	[kN]	13,0	20,0	30,0	55,0	3)	3)	
Partial safety factor	$\gamma_{Ms}^{2)}$	[-]	1,25				3)	3)	
Ductility factor	$k_7$	[-]	1,00				3)	3)	
<b>Steel failure, shear force with lever arm</b>									
<b>HST</b>									
Characteristic resistance	$M_{Rk,s}^0$	[Nm]	30	60	105	240	454	595	
Partial safety factor	$\gamma_{Ms}^{2)}$	[-]	1,25					1,50	
<b>HST-R</b>									
Characteristic resistance	$M_{Rk,s}^0$	[Nm]	27	53	92	216	422	730	
Partial safety factor	$\gamma_{Ms}^{2)}$	[-]	1,25			1,30	1,44		
<b>HST-HCR</b>									
Characteristic resistance	$M_{Rk,s}^0$	[Nm]	30	60	105	266	3)	3)	
Partial safety factor	$\gamma_{Ms}^{2)}$	[-]	1,25				3)	3)	

<sup>1)</sup> Only HST and HST-R

<sup>2)</sup> In absence of other national regulations

<sup>3)</sup> No performance assessed

**Hilti metal expansion anchor HST, HST-R, HST-HCR, HST3, HST3-R**

**Performances**

Characteristic values of resistance under shear loading in cracked and non-cracked concrete

**Annex C5**



**Table C3 continued**

			M8	M10	M12	M16	M20 <sup>1)</sup>	M24 <sup>1)</sup>
<b>Concrete pryout failure</b>								
<b>HST, HST-R and HST-HCR</b>								
Installation safety factor	$\gamma_{inst}$	[-]	1,00					
Pryout factor	$k_8$	[-]	2,0	2,0	2,2	2,5	2,5	2,5
<b>Concrete edge failure</b>								
<b>HST, HST-R and HST-HCR</b>								
Effective length of anchor in shear loading	$l_f$	[mm]	47	60	70	82	101	125
Diameter of anchor	$d_{nom}$	[mm]	8	10	12	16	20	24
Installation safety factor	$\gamma_{inst}$	[-]	1,00					

<sup>1)</sup> Only HST and HST-R

<sup>2)</sup> In absence of other national regulations

<sup>3)</sup> No performance assessed

**Hilti metal expansion anchor HST, HST-R, HST-HCR, HST3, HST3-R**

**Performances**

Characteristic values of resistance under shear loading in cracked and non-cracked concrete

**Annex C6**

**Table C4: Characteristic shear resistance for Hilti metal expansion anchor HST3 and HST3-R in cracked and non-cracked concrete**

			M8	M10	M12	M16	M20	M24	
<b>Steel failure, shear force without lever arm</b>									
<b>HST3</b>									
Effective embedment depth	$h_{ef,2}$	[mm]	47	60	70	85	101	125	
Characteristic resistance	$V_{Rk,s}^0$	[kN]	13,8	23,6	35,4	55,3	83,9	94,0	
Characteristic resistance using Filling Set	$V_{Rk,s}^0$	[kN]	16,6	25,8	39,0	60,9	100,4	2)	
Partial safety factor	$\gamma_{Ms}^{1)}$	[-]	1,25					1,50	
Ductility factor	$k_7$	[-]	1,00						
<b>HST3-R</b>									
Effective embedment depth	$h_{ef,2}$	[mm]	47	60	70	85	101	125	
Characteristic resistance	$V_{Rk,s}^0$	[kN]	15,7	25,3	36,7	63,6	97,2	115,0	
Characteristic resistance using Filling Set	$V_{Rk,s}^0$	[kN]	19,5	28,4	44,3	70,2	102,7	2)	
Partial safety factor	$\gamma_{Ms}^{1)}$	[-]	1,25					1,30	
Ductility factor	$k_7$	[-]	1,00						
<b>HST3</b>									
Effective embedment depth	$h_{ef,1}$	[mm]	2)	40	50	65	2)	2)	
Characteristic resistance	$V_{Rk,s}^0$	[kN]	2)	21,9	34,0	54,5	2)	2)	
Partial safety factor	$\gamma_{Ms}^{1)}$	[-]	2)	1,25			2)	2)	
Ductility factor	$k_7$	[-]	2)	1,00			2)	2)	
<b>HST3-R</b>									
Effective embedment depth	$h_{ef,1}$	[mm]	2)	40	50	65	2)	2)	
Characteristic resistance	$V_{Rk,s}^0$	[kN]	2)	25,6	31,1	48,6	2)	2)	
Partial safety factor	$\gamma_{Ms}^{1)}$	[-]	2)	1,25			2)	2)	
Ductility factor	$k_7$	[-]	2)	1,00			2)	2)	

<sup>1)</sup> In absence of other national regulations

<sup>2)</sup> No performance assessed

**Hilti metal expansion anchor HST, HST-R, HST-HCR, HST3, HST3-R**

**Performances**

Characteristic values of resistance under shear loading in cracked and non-cracked concrete

**Annex C7**

**Table C4 continued**

		M8	M10	M12	M16	M20	M24
<b>Steel failure, shear force with lever arm</b>							
<b>HST3</b>							
Characteristic resistance	$M^0_{Rk,s}$ [Nm]	30	60	105	240	457	595
Partial safety factor	$\gamma_{Ms}^{1)}$ [-]	1,25					1,50
<b>HST3-R</b>							
Characteristic resistance	$M^0_{Rk,s}$ [Nm]	27	53	93	216	425	730
Partial safety factor	$\gamma_{Ms}^{1)}$ [-]	1,25					1,30
<b>Concrete pryout failure</b>							
<b>HST3 and HST3-R</b>							
Effective embedment depth	$h_{ef,2}$ [mm]	47	60	70	85	101	125
Installation safety factor	$\gamma_{inst}$ [-]	1,00					
Pryout factor	$k_8$ [-]	2,62	2,67	2,78	3,41	3,20	2,50
<b>HST3 and HST3-R</b>							
Effective embedment depth	$h_{ef,1}$ [mm]	<sup>2)</sup>	40	50	65	<sup>2)</sup>	<sup>2)</sup>
Installation safety factor	$\gamma_{inst}$ [-]	1,00					
Pryout factor	$k_8$ [-]	<sup>2)</sup>	2,67	2,78	3,41	<sup>2)</sup>	<sup>2)</sup>
<b>Concrete edge failure</b>							
<b>HST3 and HST3-R</b>							
Effective length of anchor in shear loading	$l_{f,2}$ [mm]	47	60	70	85	101	125
Effective length of anchor in shear loading with shallow embedment depth	$l_{f,1}$ [mm]	<sup>2)</sup>	40	50	65	<sup>2)</sup>	<sup>2)</sup>
Diameter of anchor	$d_{nom}$ [mm]	8	10	12	16	20	24
Installation safety factor	$\gamma_{inst}$ [-]	1,00					

<sup>1)</sup> In absence of other national regulations

<sup>2)</sup> No performance assessed

**Hilti metal expansion anchor HST, HST-R, HST-HCR, HST3, HST3-R**

**Performances**

Characteristic values of resistance under shear loading in cracked and non-cracked concrete

**Annex C8**

**Table C5: Displacements under tension and shear loads for Hilti metal expansion anchor HST, HST-R and HST-HCR for static and quasi static loading**

			M8	M10	M12	M16	M20 <sup>1)</sup>	M24 <sup>1)</sup>
<b>Displacements under tension loading</b>								
<b>HST</b>								
Tension load in cracked concrete	N	[kN]	2,0	4,3	5,7	9,5	14,3	19,0
Corresponding displacement	$\delta_{N0}$	[mm]	1,3	0,2	0,1	0,5	1,9	2,2
	$\delta_{N\infty}$	[mm]	1,2	1,0	1,2	1,2	2,3	2,5
Tension load in non-cracked concrete	N	[kN]	3,6	7,6	9,5	16,7	23,8	28,6
Corresponding displacement	$\delta_{N0}$	[mm]	0,2	0,1	0,1	0,4	0,6	0,5
	$\delta_{N\infty}$	[mm]	1,1	1,1	1,1	1,1	1,4	1,4
<b>HST-R and HST-HCR</b>								
Tension load in cracked concrete	N	[kN]	2,4	4,3	5,7	11,9	14,3	19,0
Corresponding displacement	$\delta_{N0}$	[mm]	0,6	0,2	0,8	1,0	1,1	0,8
	$\delta_{N\infty}$	[mm]	1,5	1,2	1,4	1,2	1,2	1,7
Tension load in non-cracked concrete	N	[kN]	4,3	7,6	9,5	16,7	23,8	28,6
Corresponding displacement	$\delta_{N0}$	[mm]	0,1	0,1	0,1	0,1	0,5	0,8
	$\delta_{N\infty}$	[mm]	1,5	1,2	1,4	1,2	1,2	1,7
<b>Displacements under shear loading</b>								
<b>HST</b>								
Shear load in cracked and non-cracked concrete	V	[kN]	8,0	13,4	20,0	31,4	48,0	45,0
Corresponding displacement	$\delta_{V0}$	[mm]	2,5	2,5	3,7	4,0	2,7	2,0
	$\delta_{V\infty}$	[mm]	3,8	3,7	5,5	6,0	4,1	3,0
<b>HST-R and HST-HCR</b>								
Shear load in cracked and non-cracked concrete	V	[kN]	7,4	11,0	17,0	27,5	40,0	57,0
Corresponding displacement	$\delta_{V0}$	[mm]	1,6	3,3	4,9	2,2	2,5	2,5
	$\delta_{V\infty}$	[mm]	2,4	4,9	7,4	3,3	3,7	3,7

<sup>1)</sup> Only HST and HST-R

**Hilti metal expansion anchor HST, HST-R, HST-HCR, HST3, HST3-R**

**Performances**  
Displacements under tension and shear loading

**Annex C9**

**Table C6: Displacements under tension and shear loads for Hilti metal expansion anchor HST3 and HST3-R for static and quasi static loading**

			M8	M10	M12	M16	M20	M24
<b>Displacements under tension loading</b>								
<b>HST3</b>								
Effective embedment depth	$h_{ef,2}$	[mm]	47	60	70	85	101	125
Tension load in cracked concrete	N	[kN]	3,6	5,7	9,5	13,4	17,4	19,0
Corresponding displacement	$\delta_{N0}$	[mm]	0,6	0,6	0,8	1,8	1,3	2,2
	$\delta_{N\infty}$	[mm]	1,1	1,3	1,6	1,7	1,8	2,5
Tension load in non-cracked concrete	N	[kN]	5,7	9,5	11,9	18,9	24,4	28,6
Corresponding displacement	$\delta_{N0}$	[mm]	0,2	0,3	0,2	0,8	0,5	0,5
	$\delta_{N\infty}$	[mm]	0,4	0,5	0,4	1,5	0,9	1,4
<b>HST3-R</b>								
Effective embedment depth	$h_{ef,2}$	[mm]	47	60	70	85	101	125
Tension load in cracked concrete	N	[kN]	3,6	5,7	9,5	13,4	17,4	19,0
Corresponding displacement	$\delta_{N0}$	[mm]	0,6	0,6	0,8	1,8	1,3	0,8
	$\delta_{N\infty}$	[mm]	1,1	1,3	1,6	1,7	1,8	1,7
Tension load in non-cracked concrete	N	[kN]	5,7	9,5	11,9	18,9	24,4	28,6
Corresponding displacement	$\delta_{N0}$	[mm]	0,2	0,3	0,2	0,8	0,5	0,8
	$\delta_{N\infty}$	[mm]	0,4	0,5	0,4	1,5	0,9	1,7
<b>HST3 and HST3-R</b>								
Effective embedment depth	$h_{ef,1}$	[mm]	1)	40	50	65	1)	1)
Tension load in cracked concrete	N	[kN]	1)	4,3	6,1	9,0	1)	1)
Corresponding displacement	$\delta_{N0}$	[mm]	1)	0,6	0,4	0,6	1)	1)
	$\delta_{N\infty}$	[mm]	1)	1,3	1,6	1,7	1)	1)
Tension load in non-cracked concrete	N	[kN]	1)	6,1	8,5	12,6	1)	1)
Corresponding displacement	$\delta_{N0}$	[mm]	1)	0,2	0,7	0,8	1)	1)
	$\delta_{N\infty}$	[mm]	1)	0,4	1,2	1,5	1)	1)

1) No performance assessed

**Hilti metal expansion anchor HST, HST-R, HST-HCR, HST3, HST3-R**

**Performances**

Displacements under tension and shear loading

**Annex C10**

**Table C6 continued**

			M8	M10	M12	M16	M20	M24
<b>Displacements under shear loading</b>								
<b>HST3</b>								
Effective embedment depth	$h_{ef,2}$	[mm]	47	60	70	85	101	125
Shear load in cracked and non-cracked concrete	V	[kN]	7,9	13,5	20,2	31,6	47,9	45,0
Corresponding displacement	$\delta_{v0}$	[mm]	2,8	2,5	3,8	4,3	2,7	2,0
	$\delta_{v\infty}$	[mm]	4,2	3,7	5,6	6,4	4,1	3,0
Shear load in cracked and non-cracked concrete using Filling Set	V	[kN]	9,5	14,7	22,3	34,8	57,4	1)
Corresponding displacement	$\delta_{v0}$	[mm]	2,9	2,3	2,0	2,3	5,9	1)
	$\delta_{v\infty}$	[mm]	4,4	3,4	3,0	3,5	8,8	1)
<b>HST3-R</b>								
Effective embedment depth	$h_{ef,2}$	[mm]	47	60	70	85	101	125
Shear load in cracked and non-cracked concrete	V	[kN]	8,9	14,5	21,0	36,3	55,6	57,0
Corresponding displacement	$\delta_{v0}$	[mm]	7,1	2,3	3,3	5,7	3,2	2,5
	$\delta_{v\infty}$	[mm]	10,7	3,4	4,9	8,5	4,8	3,7
Shear load in cracked and non-cracked concrete using Filling Set	V	[kN]	11,1	16,2	25,3	40,1	58,7	1)
Corresponding displacement	$\delta_{v0}$	[mm]	1,9	2,0	2,3	3,4	4,9	1)
	$\delta_{v\infty}$	[mm]	2,9	3,0	3,4	5,0	7,3	1)

1) No performance assessed

**Hilti metal expansion anchor HST, HST-R, HST-HCR, HST3, HST3-R**

**Performances**  
Displacements under tension and shear loading

**Annex C11**

**Table C6 continued**

			M8	M10	M12	M16	M20	M24
<b>Displacements under shear loading</b>								
<b>HST3</b>								
Effective embedment depth	$h_{ef,1}$	[mm]	1)	40	50	65	1)	1)
Shear load in cracked and non-cracked concrete	V	[kN]	1)	12,5	19,4	31,1	1)	1)
Corresponding displacement	$\delta_{v0}$	[mm]	1)	4,2	3,1	4,4	1)	1)
	$\delta_{v\infty}$	[mm]	1)	6,3	4,7	6,6	1)	1)
<b>HST3-R</b>								
Effective embedment depth	$h_{ef,1}$	[mm]	1)	40	50	65	1)	1)
Shear load in cracked and non-cracked concrete	V	[kN]	1)	14,6	17,8	27,8	1)	1)
Corresponding displacement	$\delta_{v0}$	[mm]	1)	3,7	3,9	3,5	1)	1)
	$\delta_{v\infty}$	[mm]	1)	5,6	5,8	5,3	1)	1)

1) No performance assessed

**Hilti metal expansion anchor HST, HST-R, HST-HCR, HST3, HST3-R**

**Performances**

Displacements under tension and shear loading

**Annex C12**

**Table C7: Characteristic tension resistance for seismic loading for Hilti metal expansion anchor HST and HST-R, performance category C1**

			M8	M10	M12	M16	M20	M24
<b>Steel failure</b>								
<b>HST</b>								
Characteristic resistance	$N_{Rk,s,C1}$ [kN]		<sup>3)</sup>	32,0	45,0	76,0	<sup>3)</sup>	<sup>3)</sup>
Partial safety factor	$\gamma_{Ms,C1}$ <sup>1)</sup>	[-]	<sup>3)</sup>	1,50			<sup>3)</sup>	<sup>3)</sup>
<b>HST-R</b>								
Characteristic resistance	$N_{Rk,s,C1}$ [kN]		<sup>3)</sup>	28,0	40,0	69,0	<sup>3)</sup>	<sup>3)</sup>
Partial safety factor	$\gamma_{Ms,C1}$ <sup>1)</sup>	[-]	<sup>3)</sup>	1,50		1,56	<sup>3)</sup>	<sup>3)</sup>
<b>Pullout failure</b>								
<b>HST and HST-R</b>								
Characteristic resistance	$N_{Rk,p,C1}$ [kN]		<sup>3)</sup>	8,0	10,7	18,0	<sup>3)</sup>	<sup>3)</sup>
Installation safety factor	$\gamma_{inst}$	[-]	<sup>3)</sup>	1,00			<sup>3)</sup>	<sup>3)</sup>
<b>Concrete cone failure <sup>2)</sup></b>								
<b>HST and HST-R</b>								
Installation safety factor	$\gamma_{inst}$	[-]	<sup>3)</sup>	1,00			<sup>3)</sup>	<sup>3)</sup>
<b>Splitting failure <sup>2)</sup></b>								
<b>HST and HST-R</b>								
Installation safety factor	$\gamma_{inst}$	[-]	<sup>3)</sup>	1,00			<sup>3)</sup>	<sup>3)</sup>

<sup>1)</sup> In absence of other national regulations

<sup>2)</sup> For concrete cone failure and splitting failure see EN 1992-4:2018

<sup>3)</sup> No performance assessed

**Hilti metal expansion anchor HST, HST-R, HST-HCR, HST3, HST3-R**

**Performances**

Characteristic tension resistance for performance category C1

**Annex C13**



**Table C8: Characteristic tension resistance for seismic loading for Hilti metal expansion anchor HST3 and HST3-R, performance category C1**

		M8	M10	M12	M16	M20	M24
<b>Steel failure</b>							
<b>HST3</b>							
Effective embedment depth	$h_{ef,2}$ [mm]	47	60	70	85	101	3)
Characteristic resistance	$N_{Rk,s,C1}$ [kN]	19,7	32,5	45,1	76,0	124,2	3)
Partial safety factor	$\gamma_{Ms,C1}^{1)}$ [-]	1,40					3)
<b>HST3-R</b>							
Effective embedment depth	$h_{ef,2}$ [mm]	47	60	70	85	101	3)
Characteristic resistance	$N_{Rk,s,C1}$ [kN]	17,7	28,7	42,5	69,4	115,8	3)
Partial safety factor	$\gamma_{Ms,C1}^{1)}$ [-]	1,40					3)
<b>Pullout failure</b>							
<b>HST3</b>							
Effective embedment depth	$h_{ef,2}$ [mm]	47	60	70	85	101	3)
Characteristic resistance	$N_{Rk,p,C1}$ [kN]	8,0	15,0	20,0	27,0	35,0	3)
Installation safety factor	$\gamma_{inst}$ [-]	1,00					3)
Effective embedment depth	$h_{ef,1}$ [mm]	3)	3)	50	3)	3)	3)
Characteristic resistance	$N_{Rk,p,C1}$ [kN]	3)	3)	12,2	3)	3)	3)
Installation safety factor	$\gamma_{inst}$ [-]	1,00					3)
<b>HST3-R</b>							
Effective embedment depth	$h_{ef,2}$ [mm]	47	60	70	85	101	3)
Characteristic resistance	$N_{Rk,p,C1}$ [kN]	8,5	15,0	20,0	27,0	35,0	3)
Installation safety factor	$\gamma_{inst}$ [-]	1,00					3)

1) In absence of other national regulations

2) For concrete cone failure and splitting failure see EN 1992-4:2018

3) No performance assessed

**Hilti metal expansion anchor HST, HST-R, HST-HCR, HST3, HST3-R**

**Performances**

Characteristic tension resistance for performance category C1

**Annex C14**

**Table C8 continued**

			M8	M10	M12	M16	M20	M24
<b>Concrete cone failure</b> <sup>2)</sup>								
<b>HST3 and HST3-R</b>								
Effective embedment depth	$h_{ef,2}$	[mm]	47	60	70	85	101	<sup>3)</sup>
Installation safety factor	$\gamma_{inst}$	[-]	1,00					<sup>3)</sup>
<b>Splitting failure</b> <sup>2)</sup>								
<b>HST3 and HST3-R</b>								
Effective embedment depth	$h_{ef,2}$	[mm]	47	60	70	85	101	<sup>3)</sup>
Installation safety factor	$\gamma_{inst}$	[-]	1,00					<sup>3)</sup>

<sup>1)</sup> In absence of other national regulations

<sup>2)</sup> For concrete cone failure and splitting failure see EN 1992-4:2018

<sup>3)</sup> No performance assessed

**Hilti metal expansion anchor HST, HST-R, HST-HCR, HST3, HST3-R**

**Performances**

Characteristic tension resistance for performance category C1

**Annex C15**

**Table C9: Characteristic shear resistance for seismic loading for Hilti metal expansion anchor HST and HST-R, performance category C1**

			M8	M10	M12	M16	M20	M24
<b>Steel failure</b>								
<b>HST</b>								
Characteristic resistance	$V_{Rk,s,C1}$ [kN]		3)	16,0	27,0	41,3	3)	3)
Partial safety factor	$\gamma_{Ms,C1}$ 1)	[-]	3)	1,25			3)	3)
<b>HST-R</b>								
Characteristic resistance	$V_{Rk,s,C1}$ [kN]		3)	13,6	23,1	37,5	3)	3)
Partial safety factor	$\gamma_{Ms,C1}$ 1)	[-]	3)	1,25		1,30	3)	3)
<b>Concrete pryout failure 2)</b>								
<b>HST and HST-R</b>								
Installation safety factor	$\gamma_{inst}$ [-]		3)	1,00			3)	3)
<b>Concrete edge failure 2)</b>								
<b>HST and HST-R</b>								
Installation safety factor	$\gamma_{inst}$ [-]		3)	1,00			3)	3)

1) In absence of other national regulations

2) For concrete pryout failure and concrete edge failure see EN 1992-4:2018

3) No performance assessed

**Hilti metal expansion anchor HST, HST-R, HST-HCR, HST3, HST3-R**

**Performances**

Characteristic shear resistance for performance category C1

**Annex C16**

**Table C10: Characteristic shear resistance for seismic loading for Hilti metal expansion anchor HST3 and HST3-R, performance category C1**

			M8	M10	M12	M16	M20	M24
<b>Steel failure</b>								
<b>HST3</b>								
Effective embedment depth	$h_{ef,2}$	[mm]	47	60	70	85	101	3)
Characteristic resistance	$V_{Rk,s,C1}$	[kN]	12,5	21,4	32,2	48,7	77,6	3)
Characteristic resistance using Filling Set	$V_{Rk,s,C1}$	[kN]	16,6	25,8	39,0	60,9	100,4	3)
Partial safety factor	$\gamma_{Ms,C1}^{1)}$	[-]	1,25					3)
Effective embedment depth	$h_{ef,1}$	[mm]	3)	3)	50	3)	3)	3)
Characteristic resistance	$V_{Rk,s,C1}$	[kN]	3)	3)	32,3	3)	3)	3)
Partial safety factor	$\gamma_{Ms,C1}^{1)}$	[-]	1,25					3)
<b>HST3-R</b>								
Effective embedment depth	$h_{ef,2}$	[mm]	47	60	70	85	101	3)
Characteristic resistance	$V_{Rk,s,C1}$	[kN]	15,0	22,8	36,6	60,4	56,7	3)
Characteristic resistance using Filling Set	$V_{Rk,s,C1}$	[kN]	19,5	28,4	44,3	70,2	102,7	3)
Partial safety factor	$\gamma_{Ms,C1}^{1)}$	[-]	1,25					3)
<b>Concrete pryout failure <sup>2)</sup></b>								
<b>HST3 and HST3-R</b>								
Effective embedment depth	$h_{ef,2}$	[mm]	47	60	70	85	101	3)
Installation safety factor	$\gamma_{inst}$	[-]	1,00					3)
<b>Concrete edge failure <sup>2)</sup></b>								
<b>HST3 and HST3-R</b>								
Effective embedment depth	$h_{ef,2}$	[mm]	47	60	70	85	101	3)
Installation safety factor	$\gamma_{inst}$	[-]	1,00					3)

<sup>1)</sup> In absence of other national regulations

<sup>2)</sup> For concrete pryout failure and concrete edge failure see EN 1992-4:2018

<sup>3)</sup> No performance assessed

**Hilti metal expansion anchor HST, HST-R, HST-HCR, HST3, HST3-R**

**Performances**

Characteristic shear resistance for performance category C1

**Annex C17**

**Table C11: Characteristic tension resistance for seismic loading for Hilti metal expansion anchor HST and HST-R, performance category C2**

			M8	M10	M12	M16	M20	M24
<b>Steel failure</b>								
<b>HST</b>								
Characteristic resistance	$N_{Rk,s,C2}$ [kN]		<sup>3)</sup>	32,0	45,0	76,0	<sup>3)</sup>	<sup>3)</sup>
Partial safety factor	$\gamma_{Ms,C2}$ <sup>1)</sup>	[-]	<sup>3)</sup>	1,50			<sup>3)</sup>	<sup>3)</sup>
<b>HST-R</b>								
Characteristic resistance	$N_{Rk,s,C2}$ [kN]		<sup>3)</sup>	28,0	40,0	69,0	<sup>3)</sup>	<sup>3)</sup>
Partial safety factor	$\gamma_{Ms,C2}$ <sup>1)</sup>	[-]	<sup>3)</sup>	1,50		1,56	<sup>3)</sup>	<sup>3)</sup>
<b>Pullout failure</b>								
<b>HST and HST-R</b>								
Characteristic resistance	$N_{Rk,p,C2}$ [kN]		<sup>3)</sup>	3,3	10,0	12,8	<sup>3)</sup>	<sup>3)</sup>
Installation safety factor	$\gamma_{inst}$	[-]	<sup>3)</sup>	1,00			<sup>3)</sup>	<sup>3)</sup>
<b>Concrete cone failure <sup>2)</sup></b>								
<b>HST and HST-R</b>								
Installation safety factor	$\gamma_{inst}$	[-]	<sup>3)</sup>	1,00			<sup>3)</sup>	<sup>3)</sup>
<b>Splitting failure <sup>2)</sup></b>								
<b>HST and HST-R</b>								
Installation safety factor	$\gamma_{inst}$	[-]	<sup>3)</sup>	1,00			<sup>3)</sup>	<sup>3)</sup>

<sup>1)</sup> In absence of other national regulations

<sup>2)</sup> For concrete cone failure and splitting failure see EN 1992-4:2018

<sup>3)</sup> No performance assessed

**Table C12: Displacements under tension loads for seismic loading for Hilti metal expansion anchor HST and HST-R, performance category C2**

			M8	M10	M12	M16	M20	M24
<b>HST and HST-R</b>								
Displacement DLS	$\delta_{N,C2(DLS)}$ [mm]		<sup>1)</sup>	1,4	6,7	4,0	<sup>1)</sup>	<sup>1)</sup>
Displacement ULS	$\delta_{N,C2(ULS)}$ [mm]		<sup>1)</sup>	8,6	15,9	13,3	<sup>1)</sup>	<sup>1)</sup>

<sup>1)</sup> No performance assessed

**Hilti metal expansion anchor HST, HST-R, HST-HCR, HST3, HST3-R**

**Performances**

Characteristic tension resistance and displacements under tension loads for performance category C2

**Annex C18**

**Table C13: Characteristic tension resistance for seismic loading for Hilti metal expansion anchor HST3 and HST3-R, performance category C2**

		M8	M10	M12	M16	M20	M24
<b>Steel failure</b>							
<b>HST3</b>							
Effective embedment depth	$h_{ef,2}$ [mm]	47	60	70	85	101	3)
Effective embedment depth	$h_{ef,1}$ [mm]	3)	3)	50	3)	3)	3)
Characteristic resistance	$N_{Rk,s,C2}$ [kN]	19,7	32,5	45,1	76,0	124,2	3)
Partial safety factor	$\gamma_{Ms,C2}^{1)}$ [-]	1,40					3)
<b>HST3-R</b>							
Effective embedment depth	$h_{ef,2}$ [mm]	47	60	70	85	101	3)
Characteristic resistance	$N_{Rk,s,C2}$ [kN]	17,7	28,7	42,5	69,4	115,8	3)
Partial safety factor	$\gamma_{Ms,C2}^{1)}$ [-]	1,40					3)
<b>Pullout failure</b>							
<b>HST3</b>							
Effective embedment depth	$h_{ef,2}$ [mm]	47	60	70	85	101	3)
Characteristic resistance	$N_{Rk,p,C2}$ [kN]	3,0	10,4	19,5	27,0	35,0	3)
Installation safety factor	$\gamma_{inst}$ [-]	1,00					3)
Effective embedment depth	$h_{ef,1}$ [mm]	3)	3)	50	3)	3)	3)
Characteristic resistance	$N_{Rk,p,C2}$ [kN]	3)	3)	11,4	3)	3)	3)
Installation safety factor	$\gamma_{inst}$ [-]	1,00					3)
<b>HST3-R</b>							
Effective embedment depth	$h_{ef,2}$ [mm]	47	60	70	85	101	3)
Characteristic resistance	$N_{Rk,p,C2}$ [kN]	3,4	10,4	19,5	27,0	35,0	3)
Installation safety factor	$\gamma_{inst}$ [-]	1,00					3)
<b>Concrete cone failure <sup>2)</sup></b>							
<b>HST3 and HST3-R</b>							
Effective embedment depth	$h_{ef,2}$ [mm]	47	60	70	85	101	3)
Effective embedment depth	$h_{ef,1}$ [mm]	3)	3)	50	3)	3)	3)
Installation safety factor	$\gamma_{inst}$ [-]	1,00					3)

<sup>1)</sup> In absence of other national regulations

<sup>2)</sup> For concrete cone failure and splitting failure see EN 1992-4:2018

<sup>3)</sup> No performance assessed

**Hilti metal expansion anchor HST, HST-R, HST-HCR, HST3, HST3-R**

**Performances**

Characteristic tension resistance for performance category C2

**Annex C19**

**Table C13 continued**

			M8	M10	M12	M16	M20	M24
<b>Splitting failure</b> <sup>2)</sup>								
<b>HST3 and HST3-R</b>								
Effective embedment depth	$h_{ef,2}$	[mm]	47	60	70	85	101	<sup>3)</sup>
Effective embedment depth	$h_{ef,1}$	[mm]	<sup>3)</sup>	<sup>3)</sup>	50	<sup>3)</sup>	<sup>3)</sup>	<sup>3)</sup>
Installation safety factor	$\gamma_{inst}$	[-]	1,00					<sup>3)</sup>

<sup>1)</sup> In absence of other national regulations

<sup>2)</sup> For concrete cone failure and splitting failure see EN 1992-4:2018

<sup>3)</sup> No performance assessed

**Table C14: Displacements under tension loads for seismic loading for Hilti metal expansion anchor HST3 and HST3-R, performance category C2**

			M8	M10	M12	M16	M20	M24
<b>HST3 and HST3-R</b>								
Effective embedment depth	$h_{ef,2}$	[mm]	47	60	70	85	101	<sup>1)</sup>
Displacement DLS	$\delta_{N,C2(DLS)}$	[mm]	2,7	3,9	5,2	5,2	6,9	<sup>1)</sup>
Displacement ULS	$\delta_{N,C2(ULS)}$	[mm]	10,5	13,7	13,9	11,9	18,4	<sup>1)</sup>
<b>HST3</b>								
Effective embedment depth	$h_{ef,1}$	[mm]	<sup>1)</sup>	<sup>1)</sup>	50	<sup>1)</sup>	<sup>1)</sup>	<sup>1)</sup>
Displacement DLS	$\delta_{N,C2(DLS)}$	[mm]	<sup>1)</sup>	<sup>1)</sup>	1,2	<sup>1)</sup>	<sup>1)</sup>	<sup>1)</sup>
Displacement ULS	$\delta_{N,C2(ULS)}$	[mm]	<sup>1)</sup>	<sup>1)</sup>	2,5	<sup>1)</sup>	<sup>1)</sup>	<sup>1)</sup>

<sup>1)</sup> No performance assessed

**Hilti metal expansion anchor HST, HST-R, HST-HCR, HST3, HST3-R**

**Performances**

Characteristic tension resistance and displacements under tension loads for performance category C2

**Annex C20**

**Table C15: Characteristic shear resistance for seismic loading for Hilti metal expansion anchor HST and HST-R, performance category C2**

			M8	M10	M12	M16	M20	M24
<b>Steel failure</b>								
<b>HST</b>								
Characteristic resistance	$V_{Rk,s,C2}$ [kN]		3)	14,3	21,0	41,3	3)	3)
Partial safety factor	$\gamma_{Ms,C2}^{1)}$ [-]		3)	1,25			3)	3)
<b>HST-R</b>								
Characteristic resistance	$V_{Rk,s,C2}$ [kN]		3)	12,0	18,0	37,5	3)	3)
Partial safety factor	$\gamma_{Ms,C2}^{1)}$ [-]		3)	1,25		1,30	3)	3)
<b>Concrete pryout failure <sup>2)</sup></b>								
<b>HST and HST-R</b>								
Installation safety factor	$\gamma_{inst}$ [-]		3)	1,00			3)	3)
<b>Concrete edge failure <sup>2)</sup></b>								
<b>HST and HST-R</b>								
Installation safety factor	$\gamma_{inst}$ [-]		3)	1,00			3)	3)

<sup>1)</sup> In absence of other national regulations

<sup>2)</sup> For concrete pryout failure and concrete edge failure see EN 1992-4:2018

<sup>3)</sup> No performance assessed

**Table C16: Displacements under shear loads for seismic loading for Hilti metal expansion anchor HST and HST-R, performance category C2**

			M8	M10	M12	M16	M20	M24
<b>HST and HST-R</b>								
Displacement DLS	$\delta_{V,C2(DLS)}$ [mm]		1)	4,2	5,3	5,7	1)	1)
Displacement ULS	$\delta_{V,C2(ULS)}$ [mm]		1)	7,5	7,9	8,9	1)	1)

<sup>1)</sup> No performance assessed

**Hilti metal expansion anchor HST, HST-R, HST-HCR, HST3, HST3-R**

**Performances**

Characteristic shear resistance and displacements under shear loads for performance category C2

**Annex C21**



**Table C17: Characteristic shear resistance for seismic loading for Hilti metal expansion anchor HST3 and HST3-R, performance category C2**

			M8	M10	M12	M16	M20	M24
<b>Steel failure</b>								
<b>HST3</b>								
Effective embedment depth	$h_{ef,2}$	[mm]	47	60	70	85	101	3)
Characteristic resistance	$V_{Rk,s,C2}$	[kN]	9,5	16,1	26,1	42,4	66,9	3)
Characteristic resistance using Filling Set	$V_{Rk,s,C2}$	[kN]	9,9	19,0	28,6	48,5	84,3	3)
Partial safety factor	$\gamma_{Ms,C2}^{1)}$	[-]	1,25					3)
Effective embedment depth	$h_{ef,1}$	[mm]	3)	3)	50	3)	3)	3)
Characteristic resistance	$V_{Rk,s,C2}$	[kN]	3)	3)	15,6	3)	3)	3)
Partial safety factor	$\gamma_{Ms,C2}^{1)}$	[-]	1,25					3)
<b>HST3-R</b>								
Effective embedment depth	$h_{ef,2}$	[mm]	47	60	70	85	101	3)
Characteristic resistance	$V_{Rk,s,C2}$	[kN]	8,1	15,7	22,4	42,6	49,5	3)
Characteristic resistance using Filling Set	$V_{Rk,s,C2}$	[kN]	9,9	17,2	27,6	42,5	67,4	3)
Partial safety factor	$\gamma_{Ms,C2}^{1)}$	[-]	1,25					3)
<b>Concrete pryout failure <sup>2)</sup></b>								
<b>HST3 and HST3-R</b>								
Effective embedment depth	$h_{ef,2}$	[mm]	47	60	70	85	101	3)
Effective embedment depth	$h_{ef,1}$	[mm]	3)	3)	50	3)	3)	3)
Installation safety factor	$\gamma_{inst}$	[-]	1,00					3)
<b>Concrete edge failure <sup>2)</sup></b>								
<b>HST3 and HST3-R</b>								
Effective embedment depth	$h_{ef,2}$	[mm]	47	60	70	85	101	3)
Effective embedment depth	$h_{ef,1}$	[mm]	3)	3)	50	3)	3)	3)
Installation safety factor	$\gamma_{inst}$	[-]	1,00					3)

<sup>1)</sup> In absence of other national regulations

<sup>2)</sup> For concrete cone failure and splitting failure see EN 1992-4:2018

<sup>3)</sup> No performance assessed

**Hilti metal expansion anchor HST, HST-R, HST-HCR, HST3, HST3-R**

**Performances**

Characteristic shear resistance for performance category C2

**Annex C22**

**Table C18: Displacements under shear loads for seismic loading for Hilti metal expansion anchor HST3 and HST3-R, performance category C2**

			M8	M10	M12	M16	M20	M24
<b>HST3</b>								
Effective embedment depth	$h_{ef,2}$	[mm]	47	60	70	85	101	1)
Displacement DLS	$\delta_{V,C2(DLS)}$	[mm]	3,4	4,0	4,6	4,8	5,2	1)
Displacement DLS using Filling Set	$\delta_{V,C2(DLS)}$	[mm]	1,4	1,6	2,5	1,7	1,9	1)
Displacement ULS	$\delta_{V,C2(ULS)}$	[mm]	4,9	6,2	8,1	8,2	10,0	1)
Displacement ULS using Filling Set	$\delta_{V,C2(ULS)}$	[mm]	4,3	4,4	7,2	3,9	5,3	1)
Effective embedment depth	$h_{ef,1}$	[mm]	1)	1)	50	1)	1)	1)
Displacement DLS	$\delta_{V,C2(DLS)}$	[mm]	1)	1)	5,2	1)	1)	1)
Displacement ULS	$\delta_{V,C2(ULS)}$	[mm]	1)	1)	8,4	1)	1)	1)
<b>HST3-R</b>								
Effective embedment depth	$h_{ef,2}$	[mm]	47	60	70	85	101	1)
Displacement DLS	$\delta_{V,C2(DLS)}$	[mm]	3,5	5,0	6,0	5,8	3,9	1)
Displacement DLS using Filling Set	$\delta_{V,C2(DLS)}$	[mm]	1,6	1,6	2,0	1,9	2,2	1)
Displacement ULS	$\delta_{V,C2(ULS)}$	[mm]	7,5	9,1	10,1	12,3	7,0	1)
Displacement ULS using Filling Set	$\delta_{V,C2(ULS)}$	[mm]	5,0	7,6	6,8	4,7	5,8	1)

1) No performance assessed

**Hilti metal expansion anchor HST, HST-R, HST-HCR, HST3, HST3-R**

**Performances**

Displacements under shear loads for performance category C2

**Annex C23**

**Table C19: Characteristic tension resistance under fire exposure for Hilti metal expansion anchor HST, HST-R and HST-HCR in cracked and non-cracked concrete**

				M8	M10	M12	M16	M20 <sup>1)</sup>	M24 <sup>1)</sup>
<b>Steel failure</b>									
<b>HST</b>									
Characteristic resistance	R30	$N_{Rk,s,fi}$	[kN]	0,9	2,5	5,0	9,0	15,0	20,0
	R60	$N_{Rk,s,fi}$	[kN]	0,7	1,5	3,5	6,0	10,0	15,0
	R90	$N_{Rk,s,fi}$	[kN]	0,6	1,0	2,0	3,5	6,0	8,0
	R120	$N_{Rk,s,fi}$	[kN]	0,5	0,7	1,0	2,0	3,5	5,0
<b>HST-R and HST HCR</b>									
Characteristic resistance	R30	$N_{Rk,s,fi}$	[kN]	4,9	11,8	17,2	32,0	49,9	71,9
	R60	$N_{Rk,s,fi}$	[kN]	3,6	8,4	12,2	22,8	35,5	51,2
	R90	$N_{Rk,s,fi}$	[kN]	2,4	5,0	7,3	13,5	21,1	30,4
	R120	$N_{Rk,s,fi}$	[kN]	1,7	3,3	4,8	8,9	13,9	20,0
<b>Pullout failure</b>									
<b>HST</b>									
Characteristic resistance in concrete $\geq$ C20/25	R30	$N_{Rk,p,fi}$	[kN]	1,3	2,3	3,0	5,0	7,5	10,0
	R60	$N_{Rk,p,fi}$	[kN]						
	R90	$N_{Rk,p,fi}$	[kN]						
	R120	$N_{Rk,p,fi}$	[kN]	1,0	1,8	2,4	4,0	6,0	8,0
<b>HST-R and HST-HCR</b>									
Characteristic resistance in concrete $\geq$ C20/25	R30	$N_{Rk,p,fi}$	[kN]	1,3	2,3	3,0	6,3	7,5	10,0
	R60	$N_{Rk,p,fi}$	[kN]						
	R90	$N_{Rk,p,fi}$	[kN]						
	R120	$N_{Rk,p,fi}$	[kN]	1,0	1,8	2,4	5,0	6,0	8,0

<sup>1)</sup> Only HST and HST-R

In absence of other national regulations the partial safety factor for resistance under fire exposure  $\gamma_{M,fi} = 1,0$  is recommended.

**Hilti metal expansion anchor HST, HST-R, HST-HCR, HST3, HST3-R**

**Performances**

Characteristic values of resistance under tension loading under fire exposure in cracked and non-cracked concrete

**Annex C24**

**Table C19 continued**

				M8	M10	M12	M16	M20 <sup>1)</sup>	M24 <sup>1)</sup>
<b>Concrete cone failure</b>									
<b>HST, HST-R and HST-HCR</b>									
Characteristic resistance in concrete $\geq$ C20/25	R30	$N^0_{Rk,c,fi}$	[kN]	2,7	5,0	7,4	11,0	18,5	31,4
	R60	$N^0_{Rk,c,fi}$	[kN]						
	R90	$N^0_{Rk,c,fi}$	[kN]						
	R120	$N^0_{Rk,c,fi}$	[kN]						
Spacing	Scr,N	[mm]	4 h <sub>ef</sub>						
	s <sub>min</sub>	[mm]	40	55	60	70	100	125	
Edge distance	C <sub>cr,N</sub>	[mm]	2 h <sub>ef</sub>						
	C <sub>min</sub>	[mm]	Fire attack from one side: 2 h <sub>ef</sub> Fire attack from more than one side: $\geq$ 300						

<sup>1)</sup> Only HST and HST-R

In absence of other national regulations the partial safety factor for resistance under fire exposure  $\gamma_{M,fi} = 1,0$  is recommended.

**Hilti metal expansion anchor HST, HST-R, HST-HCR, HST3, HST3-R**

**Performances**

Characteristic values of resistance under tension loading under fire exposure in cracked and non-cracked concrete

**Annex C25**

**Table C20: Characteristic tension resistance under fire exposure for Hilti metal expansion anchor HST3 and HST3-R in cracked and non-cracked concrete**

			M8	M10	M12	M16	M20	M24
<b>Steel failure</b>								
<b>HST3</b>								
Effective embedment depth	$h_{ef,2}$	[mm]	47	60	70	85	101	125
Characteristic resistance	R30	$N_{Rk,s,fi}$ [kN]	0,9	2,4	5,2	9,7	15,2	21,9
	R60	$N_{Rk,s,fi}$ [kN]	0,8	1,8	3,7	6,8	10,6	15,3
	R90	$N_{Rk,s,fi}$ [kN]	0,7	1,2	2,1	3,9	6,0	8,7
	R120	$N_{Rk,s,fi}$ [kN]	0,6	0,9	1,3	2,4	3,8	5,4
<b>HST3-R</b>								
Effective embedment depth	$h_{ef,2}$	[mm]	47	60	70	85	101	125
Characteristic resistance	R30	$N_{Rk,s,fi}$ [kN]	4,9	11,8	17,1	31,9	49,8	71,8
	R60	$N_{Rk,s,fi}$ [kN]	3,6	8,4	12,2	22,8	35,5	51,2
	R90	$N_{Rk,s,fi}$ [kN]	2,4	5,0	7,3	13,6	21,2	30,6
	R120	$N_{Rk,s,fi}$ [kN]	1,7	3,3	4,8	9,0	14,1	20,3
<b>HST3</b>								
Effective embedment depth	$h_{ef,1}$	[mm]	1) <sup>1)</sup>	40	50	65	1) <sup>1)</sup>	1) <sup>1)</sup>
Characteristic resistance	R30	$N_{Rk,s,fi}$ [kN]	1) <sup>1)</sup>	1,5	2,3	4,4	1) <sup>1)</sup>	1) <sup>1)</sup>
	R60	$N_{Rk,s,fi}$ [kN]	1) <sup>1)</sup>	1,2	1,7	3,2	1) <sup>1)</sup>	1) <sup>1)</sup>
	R90	$N_{Rk,s,fi}$ [kN]	1) <sup>1)</sup>	0,9	1,1	2,1	1) <sup>1)</sup>	1) <sup>1)</sup>
	R120	$N_{Rk,s,fi}$ [kN]	1) <sup>1)</sup>	0,8	0,8	1,5	1) <sup>1)</sup>	1) <sup>1)</sup>
<b>HST3-R</b>								
Effective embedment depth	$h_{ef,1}$	[mm]	1) <sup>1)</sup>	40	50	65	1) <sup>1)</sup>	1) <sup>1)</sup>
Characteristic resistance	R30	$N_{Rk,s,fi}$ [kN]	1) <sup>1)</sup>	5,2	9,1	16,9	1) <sup>1)</sup>	1) <sup>1)</sup>
	R60	$N_{Rk,s,fi}$ [kN]	1) <sup>1)</sup>	3,7	6,8	12,6	1) <sup>1)</sup>	1) <sup>1)</sup>
	R90	$N_{Rk,s,fi}$ [kN]	1) <sup>1)</sup>	2,5	4,5	8,4	1) <sup>1)</sup>	1) <sup>1)</sup>
	R120	$N_{Rk,s,fi}$ [kN]	1) <sup>1)</sup>	2,0	3,3	6,2	1) <sup>1)</sup>	1) <sup>1)</sup>

<sup>1)</sup> No performance assessed

In absence of other national regulations the partial safety factor for resistance under fire exposure  $\gamma_{M,fi} = 1,0$  is recommended.

**Hilti metal expansion anchor HST, HST-R, HST-HCR, HST3, HST3-R**

**Performances**

Characteristic values of resistance under tension loading under fire exposure in cracked and non-cracked concrete

**Annex C26**

**Table C20 continued**

			M8	M10	M12	M16	M20	M24
<b>Pullout failure</b>								
<b>HST3 and HST3-R</b>								
Effective embedment depth	$h_{ef,2}$	[mm]	47	60	70	85	101	125
Characteristic resistance in concrete $\geq C20/25$	R30	$N_{Rk,p,fi}$ [kN]	1,9	3,0	5,0	7,1	9,1	12,6
	R60	$N_{Rk,p,fi}$ [kN]						
	R90	$N_{Rk,p,fi}$ [kN]						
	R120	$N_{Rk,p,fi}$ [kN]						
<b>HST3 and HST3-R</b>								
Effective embedment depth	$h_{ef,1}$	[mm]	1) <sup>1)</sup>	40	50	65	1) <sup>1)</sup>	1) <sup>1)</sup>
Characteristic resistance in concrete $\geq C20/25$	R30	$N_{Rk,p,fi}$ [kN]	1) <sup>1)</sup>	2,3	3,2	4,7	1) <sup>1)</sup>	1) <sup>1)</sup>
	R60	$N_{Rk,p,fi}$ [kN]						
	R90	$N_{Rk,p,fi}$ [kN]						
	R120	$N_{Rk,p,fi}$ [kN]						

<sup>1)</sup> No performance assessed

In absence of other national regulations the partial safety factor for resistance under fire exposure  $\gamma_{M,fi} = 1,0$  is recommended.

**Hilti metal expansion anchor HST, HST-R, HST-HCR, HST3, HST3-R**

**Performances**

Characteristic values of resistance under tension loading under fire exposure in cracked and non-cracked concrete

**Annex C27**

**Table C20 continued**

			M8	M10	M12	M16	M20	M24
<b>Concrete cone failure</b>								
<b>HST3 and HST3-R</b>								
Effective embedment depth	$h_{ef,2}$	[mm]	47	60	70	85	101	125
Characteristic resistance in concrete $\geq$ C20/25	R30	$N^0_{RK,c,fi}$ [kN]	2,7	5,0	7,4	12,0	18,5	31,4
	R60	$N^0_{RK,c,fi}$ [kN]						
	R90	$N^0_{RK,c,fi}$ [kN]						
	R120	$N^0_{RK,c,fi}$ [kN]						
Spacing	$s_{cr,N}$	[mm]	4 $h_{ef}$					
	$s_{min}$	[mm]	35	40	50	65	90	125
Edge distance	$c_{cr,N}$	[mm]	2 $h_{ef}$					
	$c_{min}$	[mm]	Fire attack from one side: 2 $h_{ef}$ Fire attack from more than one side: $\geq$ 300					
<b>HST3 and HST3-R</b>								
Effective embedment depth	$h_{ef,1}$	[mm]	1)	40	50	65	1)	1)
Characteristic resistance in concrete $\geq$ C20/25	R30	$N^0_{RK,c,fi}$ [kN]	1)	1,8	3,2	6,1	1)	1)
	R60	$N^0_{RK,c,fi}$ [kN]						
	R90	$N^0_{RK,c,fi}$ [kN]						
	R120	$N^0_{RK,c,fi}$ [kN]						
Spacing	$s_{cr,N}$	[mm]	1)	4 $h_{ef}$			1)	1)
	$s_{min}$	[mm]	1)	40	50	65	1)	1)
Edge distance	$c_{cr,N}$	[mm]	1)	2 $h_{ef}$			1)	1)
	$c_{min}$	[mm]	Fire attack from one side: 2 $h_{ef}$ Fire attack from more than one side: $\geq$ 300					

1) No performance assessed

In absence of other national regulations the partial safety factor for resistance under fire exposure  $\gamma_{M,fi} = 1,0$  is recommended.

**Hilti metal expansion anchor HST, HST-R, HST-HCR, HST3, HST3-R**

**Performances**

Characteristic values of resistance under tension loading under fire exposure in cracked and non-cracked concrete

**Annex C28**

**Table C21: Characteristic shear resistance under fire exposure for Hilti metal expansion anchor HST, HST-R and HST-HCR in cracked and non-cracked concrete**

				M8	M10	M12	M16	M20 <sup>1)</sup>	M24 <sup>1)</sup>
<b>Steel failure without lever arm</b>									
<b>HST</b>									
Characteristic resistance	R30	$V_{Rk,s,fi}$	[kN]	0,9	2,5	5,0	9,0	15,0	20,0
	R60	$V_{Rk,s,fi}$	[kN]	0,7	1,5	3,5	6,0	10,0	15,0
	R90	$V_{Rk,s,fi}$	[kN]	0,6	1,0	2,0	3,5	6,0	8,0
	R120	$V_{Rk,s,fi}$	[kN]	0,5	0,7	1,0	2,0	3,5	5,0
<b>HST-R and HST HCR</b>									
Characteristic resistance	R30	$V_{Rk,s,fi}$	[kN]	4,9	11,8	17,2	32,0	49,9	71,9
	R60	$V_{Rk,s,fi}$	[kN]	3,6	8,4	12,2	22,8	35,5	51,2
	R90	$V_{Rk,s,fi}$	[kN]	2,4	5,0	7,3	13,5	21,1	30,4
	R120	$V_{Rk,s,fi}$	[kN]	1,7	3,3	4,8	8,9	13,9	20,0
<b>Steel failure with lever arm</b>									
<b>HST</b>									
Characteristic resistance	R30	$M^0_{Rk,s,fi}$	[Nm]	1,0	3,3	8,1	20,6	40,2	69,5
	R60	$M^0_{Rk,s,fi}$	[Nm]	0,8	2,4	5,7	14,4	28,1	48,6
	R90	$M^0_{Rk,s,fi}$	[Nm]	0,7	1,6	3,2	8,2	16,0	27,7
	R120	$M^0_{Rk,s,fi}$	[Nm]	0,6	1,2	2,0	5,1	9,9	17,2
<b>HST-R and HST HCR</b>									
Characteristic resistance	R30	$M^0_{Rk,s,fi}$	[Nm]	5,0	15,2	26,6	67,7	132,3	228,6
	R60	$M^0_{Rk,s,fi}$	[Nm]	3,7	10,8	19,0	48,2	94,1	162,6
	R90	$M^0_{Rk,s,fi}$	[Nm]	2,4	6,4	11,3	28,6	55,9	96,6
	R120	$M^0_{Rk,s,fi}$	[Nm]	1,8	4,2	7,4	18,9	36,8	63,7

<sup>1)</sup> Only HST and HST-R

<sup>1)</sup> No performance assessed

In absence of other national regulations the partial safety factor for resistance under fire exposure  $\gamma_{M,fi} = 1,0$  is recommended.

**Hilti metal expansion anchor HST, HST-R, HST-HCR, HST3, HST3-R**

**Performances**

Characteristic values of resistance under shear loading under fire exposure in cracked and non-cracked concrete

**Annex C29**



**Table C21 continued**

			M8	M10	M12	M16	M20 <sup>1)</sup>	M24 <sup>1)</sup>
<b>Concrete pryout failure</b>								
<b>HST, HST-R and HST-HCR</b>								
Pryout factor	$k_8$	[-]	2,00	2,00	2,20	2,50	2,50	2,50
Characteristic resistance in concrete $\geq$ C20/25	R30	$V^0_{Rk,cp,fi}$ [kN]	5,4	10,0	16,0	27,2	49,4	84,5
	R60	$V^0_{Rk,cp,fi}$ [kN]						
	R90	$V^0_{Rk,cp,fi}$ [kN]						
	R120	$V^0_{Rk,cp,fi}$ [kN]						
<b>Concrete edge failure</b>								
<b>HST, HST-R and HST-HCR</b>								
The initial value $V^0_{Rk,c,fi}$ of the characteristic resistance in concrete C20/25 to C50/60 under fire exposure may be determined by: $V^0_{Rk,c,fi} = 0,25 \times V^0_{Rk,c}$ ( $\leq$ R90) $V^0_{Rk,c,fi} = 0,20 \times V^0_{Rk,c}$ (R120) with $V^0_{Rk,c}$ initial value of the characteristic resistance in cracked concrete C20/25 under normal temperature.								

<sup>1)</sup> Only HST and HST-R

<sup>1)</sup> No performance assessed

In absence of other national regulations the partial safety factor for resistance under fire exposure  $\gamma_{M,fi} = 1,0$  is recommended.

**Hilti metal expansion anchor HST, HST-R, HST-HCR, HST3, HST3-R**

**Performances**

Characteristic values of resistance under shear loading under fire exposure in cracked and non-cracked concrete

**Annex C30**

**Table C22: Characteristic shear resistance under fire exposure for Hilti metal expansion anchor HST3 and HST3-R in cracked and non-cracked concrete**

			M8	M10	M12	M16	M20	M24
<b>Steel failure without lever arm</b>								
<b>HST3</b>								
Effective embedment depth	$h_{ef,2}$	[mm]	47	60	70	85	101	125
Characteristic resistance	R30	$V_{Rk,s,fi}$ [kN]	0,9	2,4	5,2	9,7	15,2	21,9
	R60	$V_{Rk,s,fi}$ [kN]	0,8	1,8	3,7	6,8	10,6	15,3
	R90	$V_{Rk,s,fi}$ [kN]	0,7	1,2	2,1	3,9	6,0	8,7
	R120	$V_{Rk,s,fi}$ [kN]	0,6	0,9	1,3	2,4	3,8	5,4
<b>HST3-R</b>								
Effective embedment depth	$h_{ef,2}$	[mm]	47	60	70	85	101	125
Characteristic resistance	R30	$V_{Rk,s,fi}$ [kN]	4,9	11,8	17,1	31,9	49,8	71,8
	R60	$V_{Rk,s,fi}$ [kN]	3,6	8,4	12,2	22,8	35,5	51,2
	R90	$V_{Rk,s,fi}$ [kN]	2,4	5,0	7,3	13,6	21,2	30,6
	R120	$V_{Rk,s,fi}$ [kN]	1,7	3,3	4,8	9,0	14,1	20,3
<b>HST3</b>								
Effective embedment depth	$h_{ef,1}$	[mm]	1) <sup>1)</sup>	40	50	65	1) <sup>1)</sup>	1) <sup>1)</sup>
Characteristic resistance	R30	$V_{Rk,s,fi}$ [kN]	1) <sup>1)</sup>	1,5	2,3	4,4	1) <sup>1)</sup>	1) <sup>1)</sup>
	R60	$V_{Rk,s,fi}$ [kN]	1) <sup>1)</sup>	1,2	1,7	3,2	1) <sup>1)</sup>	1) <sup>1)</sup>
	R90	$V_{Rk,s,fi}$ [kN]	1) <sup>1)</sup>	0,9	1,1	2,1	1) <sup>1)</sup>	1) <sup>1)</sup>
	R120	$V_{Rk,s,fi}$ [kN]	1) <sup>1)</sup>	0,8	0,8	1,5	1) <sup>1)</sup>	1) <sup>1)</sup>
<b>HST3-R</b>								
Effective embedment depth	$h_{ef,1}$	[mm]	1) <sup>1)</sup>	40	50	65	1) <sup>1)</sup>	1) <sup>1)</sup>
Characteristic resistance	R30	$V_{Rk,s,fi}$ [kN]	1) <sup>1)</sup>	5,2	9,1	16,9	1) <sup>1)</sup>	1) <sup>1)</sup>
	R60	$V_{Rk,s,fi}$ [kN]	1) <sup>1)</sup>	3,7	6,8	12,6	1) <sup>1)</sup>	1) <sup>1)</sup>
	R90	$V_{Rk,s,fi}$ [kN]	1) <sup>1)</sup>	2,5	4,5	8,4	1) <sup>1)</sup>	1) <sup>1)</sup>
	R120	$V_{Rk,s,fi}$ [kN]	1) <sup>1)</sup>	2,0	3,3	6,2	1) <sup>1)</sup>	1) <sup>1)</sup>

<sup>1)</sup> No performance assessed

In absence of other national regulations the partial safety factor for resistance under fire exposure  $\gamma_{M,fi} = 1,0$  is recommended.

**Hilti metal expansion anchor HST, HST-R, HST-HCR, HST3, HST3-R**

**Performances**

Characteristic values of resistance under shear loading under fire exposure in cracked and non-cracked concrete

**Annex C31**

**Table C22 continued**

			M8	M10	M12	M16	M20	M24
<b>Steel failure with lever arm</b>								
<b>HST3</b>								
Effective embedment depth	$h_{ef,2}$	[mm]	47	60	70	85	101	125
Characteristic resistance	R30	$M^0_{Rk,s,fi}$ [Nm]	0,9	3,1	8,1	20,6	40,2	69,5
	R60	$M^0_{Rk,s,fi}$ [Nm]	0,8	2,4	5,7	14,4	28,1	48,6
	R90	$M^0_{Rk,s,fi}$ [Nm]	0,7	1,6	3,2	8,2	16,0	27,7
	R120	$M^0_{Rk,s,fi}$ [Nm]	0,6	1,2	2,0	5,1	10,0	17,2
<b>HST3-R</b>								
Effective embedment depth	$h_{ef,2}$	[mm]	47	60	70	85	101	125
Characteristic resistance	R30	$M^0_{Rk,s,fi}$ [Nm]	5,0	15,2	26,6	67,6	132,0	228,2
	R60	$M^0_{Rk,s,fi}$ [Nm]	3,7	10,8	19,0	48,2	94,1	162,7
	R90	$M^0_{Rk,s,fi}$ [Nm]	2,4	6,5	11,3	28,8	56,3	97,2
	R120	$M^0_{Rk,s,fi}$ [Nm]	1,8	4,3	7,5	19,1	37,3	64,5
<b>HST3</b>								
Effective embedment depth	$h_{ef,1}$	[mm]	1) <sup>1)</sup>	40	50	65	1) <sup>1)</sup>	1) <sup>1)</sup>
Characteristic resistance	R30	$M^0_{Rk,s,fi}$ [Nm]	1) <sup>1)</sup>	2,0	3,6	9,3	1) <sup>1)</sup>	1) <sup>1)</sup>
	R60	$M^0_{Rk,s,fi}$ [Nm]	1) <sup>1)</sup>	1,6	2,7	6,9	1) <sup>1)</sup>	1) <sup>1)</sup>
	R90	$M^0_{Rk,s,fi}$ [Nm]	1) <sup>1)</sup>	1,2	1,8	4,5	1) <sup>1)</sup>	1) <sup>1)</sup>
	R120	$M^0_{Rk,s,fi}$ [Nm]	1) <sup>1)</sup>	1,0	1,3	3,3	1) <sup>1)</sup>	1) <sup>1)</sup>
<b>HST3-R</b>								
Effective embedment depth	$h_{ef,1}$	[mm]	1) <sup>1)</sup>	40	50	65	1) <sup>1)</sup>	1) <sup>1)</sup>
Characteristic resistance	R30	$M^0_{Rk,s,fi}$ [Nm]	1) <sup>1)</sup>	6,7	14,1	35,9	1) <sup>1)</sup>	1) <sup>1)</sup>
	R60	$M^0_{Rk,s,fi}$ [Nm]	1) <sup>1)</sup>	4,8	10,5	26,8	1) <sup>1)</sup>	1) <sup>1)</sup>
	R90	$M^0_{Rk,s,fi}$ [Nm]	1) <sup>1)</sup>	3,2	7,0	17,7	1) <sup>1)</sup>	1) <sup>1)</sup>
	R120	$M^0_{Rk,s,fi}$ [Nm]	1) <sup>1)</sup>	2,6	5,2	13,2	1) <sup>1)</sup>	1) <sup>1)</sup>

<sup>1)</sup> No performance assessed

In absence of other national regulations the partial safety factor for resistance under fire exposure  $\gamma_{M,fi} = 1,0$  is recommended.

**Hilti metal expansion anchor HST, HST-R, HST-HCR, HST3, HST3-R**

**Performances**

Characteristic values of resistance under shear loading under fire exposure in cracked and non-cracked concrete

**Annex C32**

**Table C22 continued**

			M8	M10	M12	M16	M20	M24
<b>Concrete pryout failure</b>								
<b>HST3 and HST3-R</b>								
Effective embedment depth	$h_{ef,2}$	[mm]	47	60	70	85	101	125
Pryout factor	$k_8$	[-]	2,62	2,67	2,78	3,41	3,20	2,50
Characteristic resistance in concrete $\geq$ C20/25	R30	$V^0_{Rk,cp,fi}$ [kN]	7,0	13,0	20,7	40,8	37,0	62,8
	R60	$V^0_{Rk,cp,fi}$ [kN]						
	R90	$V^0_{Rk,cp,fi}$ [kN]						
	R120	$V^0_{Rk,cp,fi}$ [kN]						
<b>HST3 and HST3-R</b>								
Effective embedment depth	$h_{ef,1}$	[mm]	1)	40	50	65	1)	1)
Pryout factor	$k_8$	[-]	1)	2,67	2,78	3,41	1)	1)
Characteristic resistance in concrete $\geq$ C20/25	R30	$V^0_{Rk,cp,fi}$ [kN]	1)	4,7	8,9	20,8	1)	1)
	R60	$V^0_{Rk,cp,fi}$ [kN]						
	R90	$V^0_{Rk,cp,fi}$ [kN]						
	R120	$V^0_{Rk,cp,fi}$ [kN]						
<b>Concrete edge failure</b>								
<b>HST3 and HST3-R</b>								
The initial value $V^0_{Rk,c,fi}$ of the characteristic resistance in concrete C20/25 to C50/60 under fire exposure may be determined by: $V^0_{Rk,c,fi} = 0,25 \times V^0_{Rk,c}$ ( $\leq$ R90) $V^0_{Rk,c,fi} = 0,20 \times V^0_{Rk,c}$ (R120) with $V^0_{Rk,c}$ initial value of the characteristic resistance in cracked concrete C20/25 under normal temperature.								

1) No performance assessed

In absence of other national regulations the partial safety factor for resistance under fire exposure  $\gamma_{M,fi} = 1,0$  is recommended.

**Hilti metal expansion anchor HST, HST-R, HST-HCR, HST3, HST3-R**

**Performances**

Characteristic values of resistance under shear loading under fire exposure in cracked and non-cracked concrete

**Annex C33**



Zulassungsstelle für Bauprodukte und Bauarten

Bautechnisches Prüfamt

Eine vom Bund und den Ländern  
gemeinsam getragene Anstalt des öffentlichen Rechts



## Europäische Technische Bewertung

ETA-98/0001  
vom 13. Juli 2020

### Allgemeiner Teil

Technische Bewertungsstelle, die die Europäische Technische Bewertung ausstellt

Handelsname des Bauprodukts

Produktfamilie,  
zu der das Bauprodukt gehört

Hersteller

Herstellungsbetrieb

Diese Europäische Technische Bewertung enthält

Diese Europäische Technische Bewertung wird ausgestellt gemäß der Verordnung (EU) Nr. 305/2011, auf der Grundlage von

Diese Fassung ersetzt

Deutsches Institut für Bautechnik

Hilti Metallspreizanker HST, HST-R, HST-HCR, HST3, HST3-R

Mechanischer Dübel zur Verankerung im Beton

Hilti Aktiengesellschaft  
Business Unit Anchors  
9494 Schaan  
FÜRSTENTUM LIECHTENSTEIN

Hilti Werke

63 Seiten, davon 3 Anhänge, die fester Bestandteil dieser Bewertung sind.

EAD 330232-01-0601 Edition 12/2019

ETA-98/0001 vom 2. Oktober 2019

Die Europäische Technische Bewertung wird von der Technischen Bewertungsstelle in ihrer Amtssprache ausgestellt. Übersetzungen dieser Europäischen Technischen Bewertung in andere Sprachen müssen dem Original vollständig entsprechen und müssen als solche gekennzeichnet sein.

Diese Europäische Technische Bewertung darf, auch bei elektronischer Übermittlung, nur vollständig und ungekürzt wiedergegeben werden. Nur mit schriftlicher Zustimmung der ausstellenden Technischen Bewertungsstelle kann eine teilweise Wiedergabe erfolgen. Jede teilweise Wiedergabe ist als solche zu kennzeichnen.

Die ausstellende Technische Bewertungsstelle kann diese Europäische Technische Bewertung widerrufen, insbesondere nach Unterrichtung durch die Kommission gemäß Artikel 25 Absatz 3 der Verordnung (EU) Nr. 305/2011.

## Besonderer Teil

### 1 Technische Beschreibung des Produkts

Der Hilti Metallspreizanker HST, HST-R, HST-HCR, HST3 und HST3-R ist ein Dübel aus galvanisch verzinktem Stahl (HST, HST3), aus nichtrostendem Stahl (HST-R, HST3-R) oder hochkorrosionsbeständigem Stahl (HST-HCR) der in ein Bohrloch gesteckt und kraftkontrolliert verankert wird.

Die Produktbeschreibung ist in Anhang A angegeben.

### 2 Spezifizierung des Verwendungszwecks gemäß dem anwendbaren Europäischen Bewertungsdokument

Von den Leistungen in Abschnitt 3 kann nur ausgegangen werden, wenn der Dübel entsprechend den Angaben und Bedingungen nach Anhang B verwendet wird.

Die Prüf- und Bewertungsmethoden, die dieser Europäischen Technischen Bewertung zu Grunde liegen, führen zur Annahme einer Nutzungsdauer des Dübels von mindestens 50 Jahren. Die Angabe der Nutzungsdauer kann nicht als Garantie des Herstellers verstanden werden, sondern ist lediglich ein Hilfsmittel zur Auswahl des richtigen Produkts in Bezug auf die angenommene wirtschaftlich angemessene Nutzungsdauer des Bauwerks.

### 3 Leistung des Produkts und Angabe der Methoden ihrer Bewertung

#### 3.1 Mechanische Festigkeit und Standsicherheit (BWR 1)

Wesentliches Merkmal	Leistung
Charakteristische Widerstände unter Zugbeanspruchung (statische und quasi-statische Lasten) Methode A	Siehe Anhang B8 bis B13, C1 bis C4
Charakteristische Widerstände unter Querlast (statische und quasi-statische Lasten)	Siehe Anhang C5 bis C8
Verschiebungen und Dauerhaftigkeit	Siehe Anhang B1, C9 bis C12
Charakteristische Widerstände und Verschiebungen für die seismische Leistungskategorie C1 und C2	Siehe Anhang C13 bis C23

#### 3.2 Brandschutz (BWR 2)

Wesentliches Merkmal	Leistung
Brandverhalten	Klasse A1
Feuerwiderstand	Siehe Anhang C24 bis C33



**4 Angewandtes System zur Bewertung und Überprüfung der Leistungsbeständigkeit mit der Angabe der Rechtsgrundlage**

Gemäß dem Europäischen Bewertungsdokument EAD 330232-01-0601 gilt folgende Rechtsgrundlage: [96/582/EG].

Folgendes System ist anzuwenden: 1

**5 Für die Durchführung des Systems zur Bewertung und Überprüfung der Leistungsbeständigkeit erforderliche technische Einzelheiten gemäß anwendbarem Europäischen Bewertungsdokument**

Technische Einzelheiten, die für die Durchführung des Systems zur Bewertung und Überprüfung der Leistungsbeständigkeit notwendig sind, sind Bestandteil des Kontrollplans, der beim Deutschen Institut für Bautechnik hinterlegt ist.

Ausgestellt in Berlin am 13. Juli 2020 vom Deutschen Institut für Bautechnik

Dr.-Ing. Lars Eckfeldt  
i. V. Abteilungsleiter

Beglaubigt  
Lange

## Einbauzustand

### Bild A1:

Hilti Metallspreizanker HST, HST-R und HST-HCR

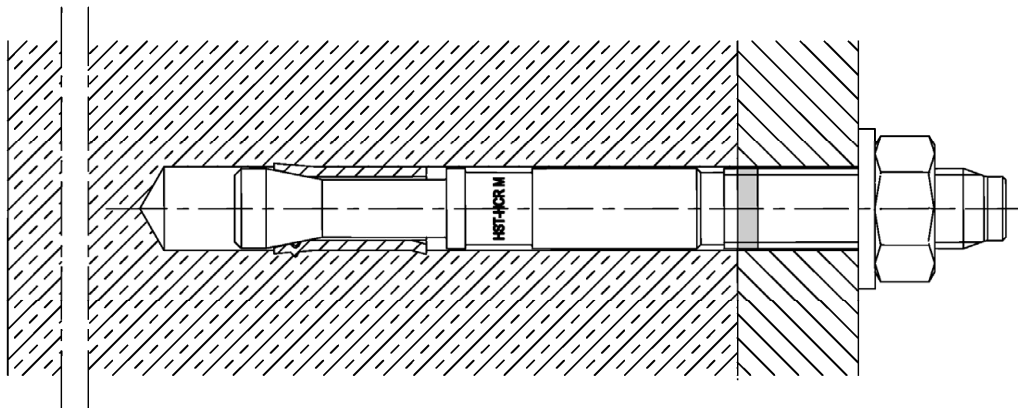

### Bild A2:

Hilti Metallspreizanker HST3 und HST3-R mit Standardeinbindetiefe und verkürzter Einbindetiefe

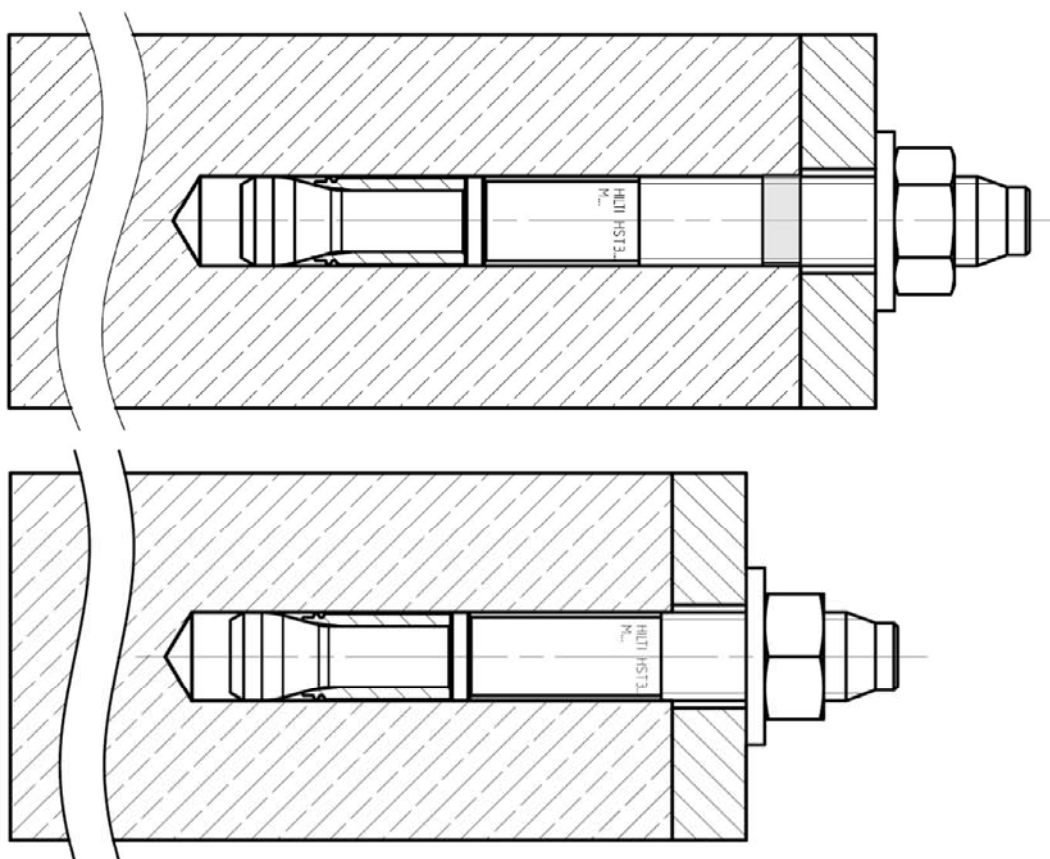

Hilti Metallspreizanker HST, HST-R, HST-HCR, HST3, HST3-R

Produktbeschreibung  
Einbauzustand

Anhang A1

**Bild A3:**

Hilti Metallspreizanker HST3 und HST3-R mit Verfüll-Set

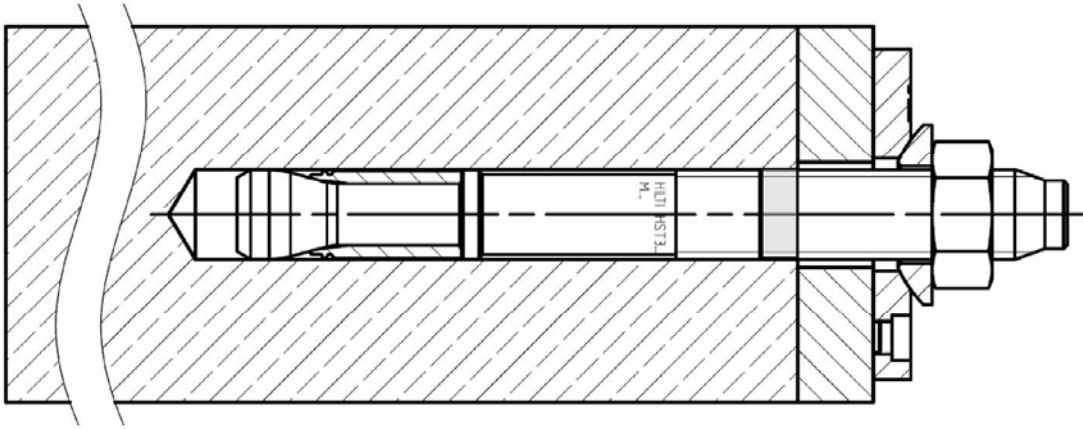

Hilti Metallspreizanker HST, HST-R, HST-HCR, HST3, HST3-R

Produktbeschreibung  
Einbauzustand

Anhang A2

## Produktbeschreibung: Hilti Metallspreizanker HST, HST-R und HST-HCR

### Kaltumgeformt hergestellte Variante

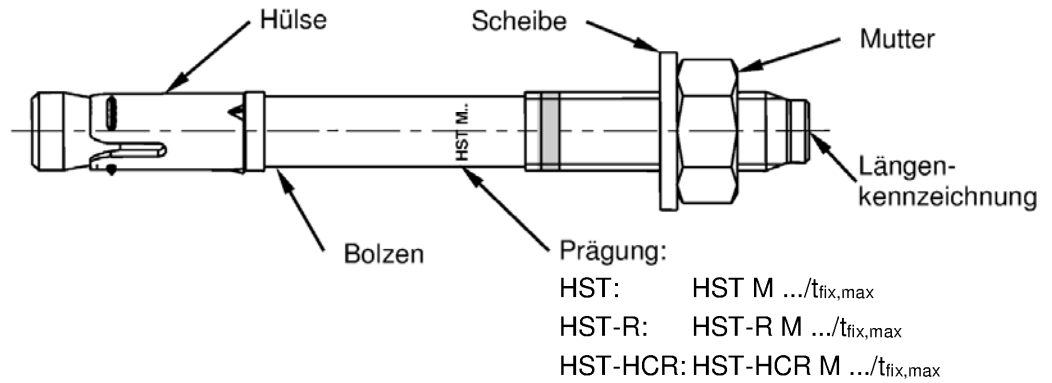

### Zerspant hergestellte Variante

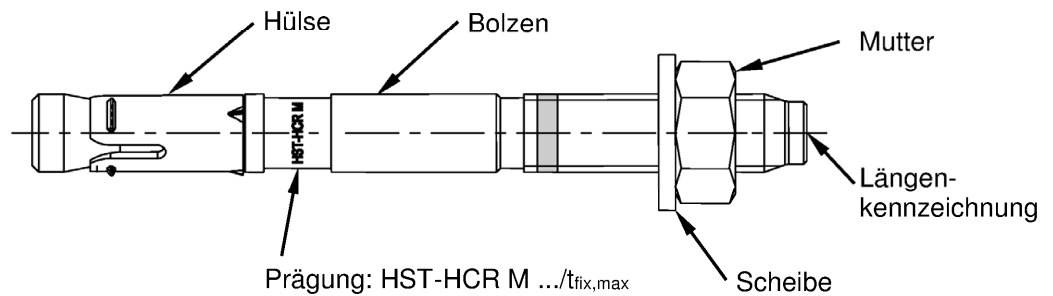

Hilti Metallspreizanker HST, HST-R, HST-HCR, HST3, HST3-R

**Produktbeschreibung**  
Varianten, Prägung und Kennzeichnung

**Anhang A3**

## Produktbeschreibung: Hilti Metallspreizanker HST3 und HST3-R

### Kaltumgeformt hergestellte Variante

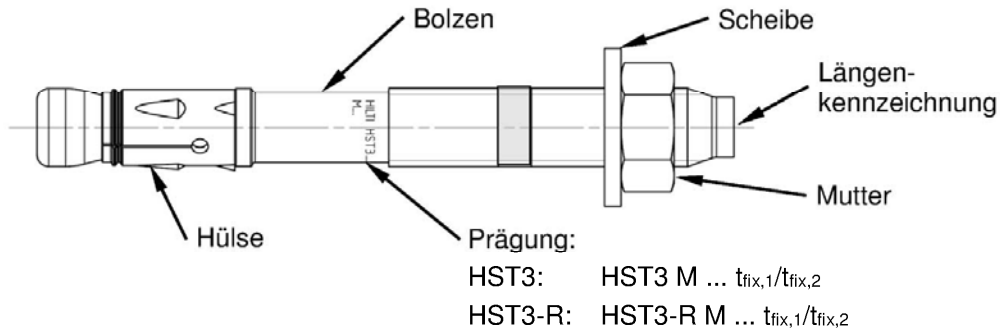

### Zerspant hergestellte Variante M8 – M16

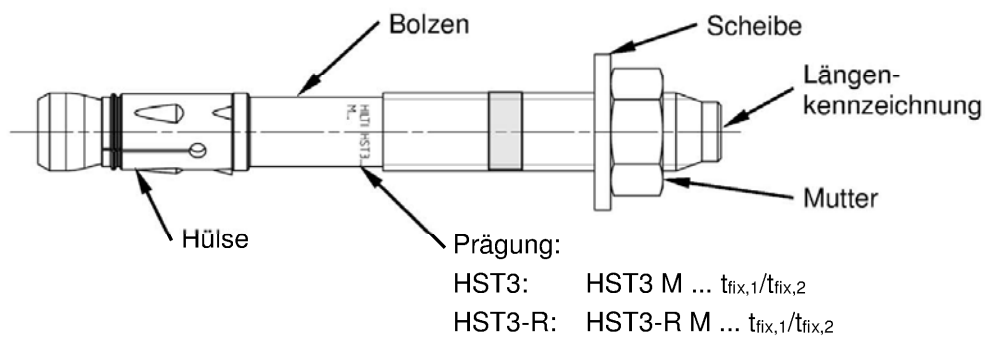

### Zerspant hergestellte Variante M20 - M24

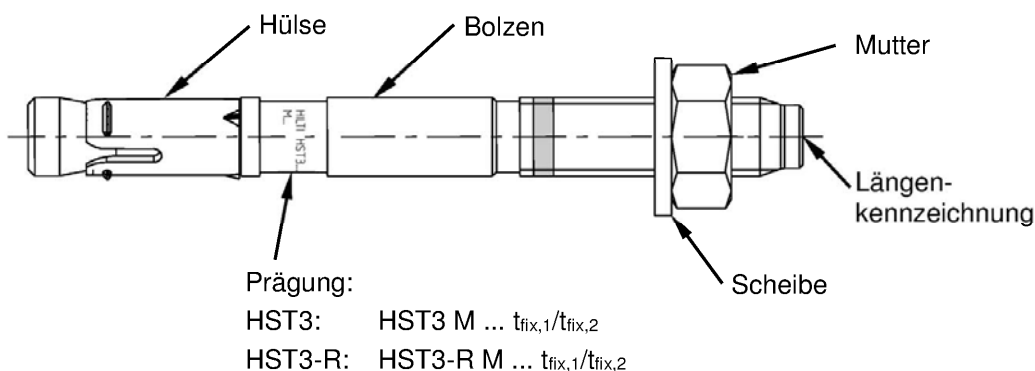

## Hilti Metallspreizanker HST, HST-R, HST-HCR, HST3, HST3-R

**Produktbeschreibung**  
Varianten, Prägung und Kennzeichnung

**Anhang A4**

**Tabelle A1: Längenkennzeichnung HST, HST3, HST-R, HST3-R, HST-HCR**

Buchstabe		A	B	C	D	E	f	II
Ankerlänge	≥ [mm]	38,1	50,8	63,5	76,2	88,9	100,0	100,0
	< [mm]	50,8	63,5	76,2	88,9	101,6	100,0	100,0

Buchstabe		F	G	Δ	H	I	J	K
Ankerlänge	≥ [mm]	101,6	114,3	125,0	127,0	139,7	152,4	165,1
	< [mm]	114,3	127,0	125,0	139,7	152,4	165,1	177,8

Buchstabe		L	M	N	O	P	Q	R
Ankerlänge	≥ [mm]	177,8	190,5	203,2	215,9	228,6	241,3	254,0
	< [mm]	190,5	203,2	215,9	228,6	241,3	254,0	279,4

Buchstabe		r	S	T	U	V	W	X
Ankerlänge	≥ [mm]	260,0	279,4	304,8	330,2	355,6	381,0	406,4
	< [mm]	260,0	304,8	330,2	355,6	381,0	406,4	431,8

Buchstabe		Y	Z	AA	BB	CC	DD	EE
Ankerlänge	≥ [mm]	431,8	457,2	482,6	508,0	533,4	558,8	584,2
	< [mm]	457,2	482,6	508,0	533,4	558,8	584,2	609,6

Buchstabe		FF	GG	HH	II	JJ	KK	LL
Ankerlänge	≥ [mm]	609,6	635,0	660,4	685,8	711,2	736,6	762,0
	< [mm]	635,0	660,4	685,8	711,2	736,6	762,0	787,4

Buchstabe		MM	NN	OO	PP	QQ	RR	SS
Ankerlänge	≥ [mm]	787,4	812,8	838,2	863,6	889,0	914,4	939,8
	< [mm]	812,8	838,2	863,6	889,0	914,4	939,8	965,2

Buchstabe		TT	UU	VV
Ankerlänge	≥ [mm]	965,2	990,6	1016,0
	< [mm]	990,6	1016,0	1041,4

**Hilti Metallspreizanker HST, HST-R, HST-HCR, HST3, HST3-R**

**Produktbeschreibung**  
Varianten, Prägung und Kennzeichnung

**Anhang A5**

**Tabelle A2: Werkstoffe**

Bezeichnung	Werkstoff
<b>HST</b>	
Spreizhülse	Nichtrostender Stahl A4 nach EN 10088-1-2014
Bolzen	C-Stahl, galvanisch verzinkt, beschichtet (transparent), Bruchdehnung ( $l_0 = 5d$ ) > 8 %
Scheibe	C-Stahl, galvanisch verzinkt
Sechskantmutter	C-Stahl, galvanisch verzinkt
<b>HST-R (nichtrostender Stahl) Korrosionswiderstandsklasse III nach EN 1993-1-4:2006+A1:2015</b>	
Spreizhülse	Nichtrostender Stahl A4 nach EN 10088-1:2014
Bolzen	Nichtrostender Stahl A4 nach EN 10088-1:2014, Konus beschichtet (rot oder transparent), Bruchdehnung ( $l_0 = 5d$ ) > 8 %
Scheibe	Nichtrostender Stahl A4 nach DIN EN ISO 3506-1:2010
Sechskantmutter	Nichtrostender Stahl A4 nach DIN EN ISO 3506-2:2010, beschichtet
<b>HST-HCR (hochkorrosionsbeständiger Stahl) Korrosionswiderstandsklasse V nach EN 1993-1-4:2006+A1:2015</b>	
Spreizhülse	Nichtrostender Stahl A4 nach EN 10088-1:2014
Bolzen	Hochkorrosionsbeständiger Stahl nach EN 10088-1:2014, Konus beschichtet (rot), Bruchdehnung ( $l_0 = 5d$ ) > 8 %
Scheibe	Hochkorrosionsbeständiger Stahl nach EN 10088-1:2014
Sechskantmutter	Hochkorrosionsbeständiger Stahl nach EN 10088-1:2014, beschichtet

Hilti Metallspreizanker HST, HST-R, HST-HCR, HST3, HST3-R

Produktbeschreibung  
Werkstoffe

Anhang A6

**Tabelle A2 fortgesetzt**

Bezeichnung	Werkstoff
<b>HST3</b>	
Spreizhülse	M10, M16: C-Stahl, galvanisch verzinkt oder nichtrostender Stahl nach EN 10088-1:2014 M8, M12, M20, M24: nichtrostender Stahl nach EN 10088-1:2014
Bolzen	C-Stahl, galvanisch verzinkt, beschichtet (transparent), Bruchdehnung ( $l_0 = 5d$ ) > 8 %
Scheibe	C-Stahl, galvanisch verzinkt
Sechskantmutter	C-Stahl, galvanisch verzinkt
<b>Verfüll-Set</b>	
Verschlussscheibe	C-Stahl, galvanisch verzinkt
Kugelscheibe	C-Stahl, galvanisch verzinkt
<b>HST3-R (nichtrostender Stahl)</b> <b>Korrosionswiderstandsklasse III nach EN 1993-1-4:2006+A1:2015</b>	
Spreizhülse	Nichtrostender Stahl A4 nach EN 10088-1:2014
Bolzen	Nichtrostender Stahl A4 nach EN 10088-1:2014, Konus beschichtet (transparent), Bruchdehnung ( $l_0 = 5d$ ) > 8 %
Scheibe	Nichtrostender Stahl A4 nach DIN EN ISO 3506-1:2010
Sechskantmutter	Nichtrostender Stahl A4 nach DIN EN ISO 3506-2:2010, beschichtet
<b>Verfüll-Set (nichtrostender Stahl)</b> <b>Korrosionswiderstandsklasse III nach EN 1993-1-4:2006+A1:2015</b>	
Verschlussscheibe	Nichtrostender Stahl A4 nach ASTM A 240/A 240M:2019
Kugelscheibe	Nichtrostender Stahl A4 nach EN 10088-1-2014

Hilti Metallpreisanker HST, HST-R, HST-HCR, HST3, HST3-R

Produktbeschreibung  
Werkstoffe

Anhang A7



### Injektionsmörtel Hilti HIT-HY 200-A

Hybridsystem mit Harz, Härter, Zement und Wasser  
Foliengebinde 330 ml und 500 ml

Kennzeichnung:  
HILTI HIT  
Chargennummer und  
Produktionslinie  
Verfallsdatum mm/jjjj



Produktname: "Hilti HIT-HY 200-A"

### Statikmischer Hilti HIT-RE-M



### Auspressgeräte



Hilti HDM 330



Hilti HDE 500

### Tabelle A3: Aushärtezeit Hilti HIT-HY 200-A

Untergrund- / Umgebungstemperatur	Aushärtezeit $t_{\text{cure}}$ Hilti HIT-HY 200-A
-10 °C bis -5 °C	7 Stunden
-4 °C bis 0 °C	4 Stunden
1 °C bis 5 °C	2 Stunden
6 °C bis 10 °C	75 Minuten
11 °C bis 20 °C	45 Minuten
21 °C bis 30 °C	30 Minuten
31 °C bis 40 °C	30 Minuten

Hilti Metallspreizanker HST, HST-R, HST-HCR, HST3, HST3-R

Produktbeschreibung  
Injektionsmörtel

Anhang A8

**Tabelle A4: Abmessungen HST, HST-R und HST-HCR**

HST, HST-R, HST-HCR			M8	M10	M12	M16	M20 <sup>1)</sup>	M24 <sup>1)</sup>
Maximale Ankerlänge	$l_{\max} \leq$	[mm]	260	280	295	350	450	500
Schaftdurchmesser am Konus	$d_R$	[mm]	5,5	7,2	8,5	11,6	14,6	17,4
Sprezhülsenlänge	$l_S$	[mm]	14,8	18,2	22,7	24,3	28,3	36,0

<sup>1)</sup> Nur HST und HST-R

**HST, HST-R und HST-HCR**

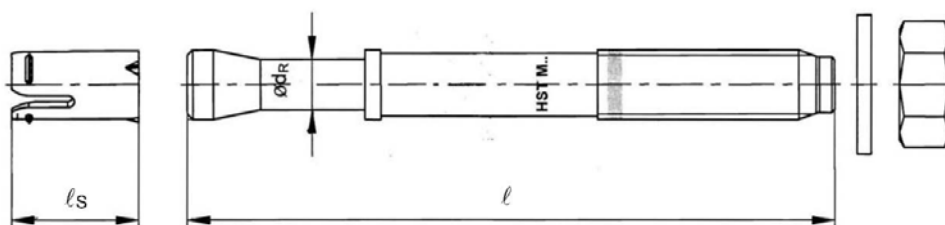

**Tabelle A5: Abmessungen HST3 und HST3-R**

HST3, HST3-R			M8	M10	M12	M16	M20	M24
Maximale Ankerlänge	$l_{\max} \leq$	[mm]	260	280	350	475	450	500
Schaftdurchmesser am Konus	$d_R$	[mm]	5,60	6,94	8,22	11,00	14,62	17,4
Sprezhülsenlänge	$l_S$	[mm]	13,6	16,0	20,0	25,0	28,3	36,0
Scheibendurchmesser	$d_w \geq$	[mm]	15,57	19,48	23,48	29,48	36,38	43,38

**HST3 und HST3-R**

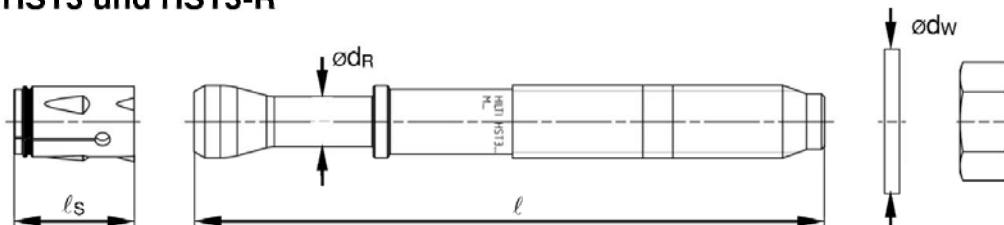

Hilti Metallspreizanker HST, HST-R, HST-HCR, HST3, HST3-R

Produktbeschreibung  
Abmessungen

Anhang A9

## Verfüll-Set zum Verfüllen des Ringspalts zwischen Anker und Anbauteil

**Tabelle A6: Abmessungen Verfüll-Set**

Verfüll-Set für HST3, HST3-R			M8	M10	M12	M16	M20
Durchmesser Verschluss Scheibe	dvs	[mm]	38	42	44	52	60
Verschluss Scheibenhöhe	hvs	[mm]	5			6	

Verschluss Scheibe

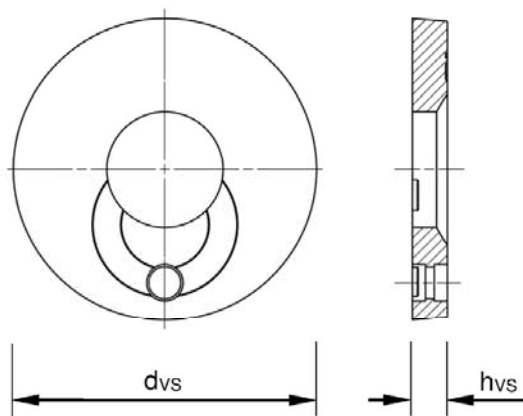

Kugelscheibe

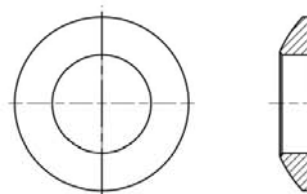

Hilti Metallspreizanker HST, HST-R, HST-HCR, HST3, HST3-R

Produktbeschreibung  
Abmessungen

Anhang A10

## Angaben zum Verwendungszweck

### Verankerungsgrund:

- Verdichteter bewehrter oder unbewehrter Normalbeton ohne Fasern nach EN 206-1:2013 + A1:2016.
- Festigkeitsklasse C20/25 bis C50/60 nach EN 206:2013 + A1:2016.
- Gerissener und ungerissener Beton.

### Anwendungsbedingungen (Umweltbedingungen):

- In Bauteilen unter den Bedingungen trockener Innenräume (alle Stahlsorten).
- Für alle anderen Bedingungen entsprechend EN 1993-1-4 + A1:2015 Korrosionsbeständigkeitsklasse nach Anhang A6 Tabelle A1 (nichtrostende Stähle).

### Bemessung:

- Die Befestigungen müssen unter der Verantwortung eines auf dem Gebiet der Verankerungen und des Betonbaus erfahrenen Ingenieurs bemessen werden.
- Unter Berücksichtigung der zu verankernden Lasten sind prüfbare Berechnungen und Konstruktionszeichnungen anzufertigen. Auf den Konstruktionszeichnungen ist die Lage des Dübels (z. B. Lage des Dübels zur Bewehrung oder zu den Auflagern usw.) anzugeben.
- Die Bemessung von Verankerungen erfolgt in Übereinstimmung mit:  
EN 1992-4:2018 und EOTA Technical Report TR 055, 12/2016
- Bei Anforderungen an den Brandschutz ist sicherzustellen, dass lokale Betonabplatzungen vermieden werden.

Hilti Metallspreizanker HST, HST-R, HST-HCR, HST3, HST3-R

Angaben zum Verwendungszweck

Anhang B1



- **Einbau:**
- Der Einbau erfolgt durch entsprechend geschultes Personal unter der Aufsicht des Bauleiters.
- Der Dübel darf nur einmal verwendet werden.
- Überkopfmontage ist zulässig.

**Tabelle B1: Bohrlocherstellung HST, HST-R und HST-HCR**



HST, HST-R und HST-HCR	M8	M10	M12	M16	M20 <sup>1)</sup>	M24 <sup>1)</sup>
Hammerbohren (HD) 	✓	✓	✓	✓	✓	✓

<sup>1)</sup> Nur HST und HST-R

**Tabelle B2: Bohrlocherstellung HST3 und HST3-R**

HST3 und HST3-R	M8	M10	M12	M16	M20	M24
Hammerbohren (HD) 	✓	✓	✓	✓	✓	✓
Diamantbohrverfahren (DD) mit <ul style="list-style-type: none"> <li>• DD EC-1 Diamantbohrgerät und DD-C ... TS/TL Bohrkronen oder DD-C ... T2/T4 Bohrkronen </li> <li>• DD 30-W Diamantbohrgerät und C+ ... SPX-T (abrasiv) Bohrkronen</li> </ul>	✓	✓	✓	✓	✓	✓
Hammerbohren mit Hohlbohrer (HDB) mit TE-CD/YD ... Hohlbohrern 	-	-	✓	✓	✓	✓

**Tabelle B3: Bohrloch Reinigung**

<b>Handreinigung (MC):</b> Zum Ausblasen von Bohrlöchern wird die Hilti-Handausblaspumpe empfohlen.	
<b>Druckluftreinigung (CAC):</b> Zum Ausblasen mit Druckluft wird die Verwendung einer Ausblasdüse mit einem Durchmesser von mindestens 3,5 mm empfohlen.	
<b>Automatische Bohrlochreinigung (AC):</b> Die Reinigung wird während des Bohrens mit dem Hilti-Hohlbohrer TE-CD und TE-YD Bohrsystem inklusive Staubsauger durchgeführt.	

Hilti Metallspreizanker HST, HST-R, HST-HCR, HST3, HST3-R

Angaben zum Verwendungszweck



Anhang B2

**Tabelle B4: Anziehen des Metallspreizankers HST, HST-R und HST-HCR**

HST, HST-R und HST-HCR	M8	M10	M12	M16	M20 <sup>1)</sup>	M24 <sup>1)</sup>
Drehmomentschlüssel 	✓	✓	✓	✓	✓	✓

<sup>1)</sup> Nur HST und HST-R

**Tabelle B5: Anziehen des Metallspreizankers HST3 und HST3-R**

HST3 und HST3-R	M8	M10	M12	M16	M20	M24
Drehmomentschlüssel 	✓	✓	✓	✓	✓	✓
Maschinensetzen mit Hilti SIW 6AT-A22 Schlagschrauber und SI-AT-A22 Anzugsmodul 	✓	✓	✓	-	-	-

**Tabelle B6: Übersicht der Leistungskategorien HST, HST-R und HST-HCR**

Beanspruchung:	HST, HST-R, HST-HCR
Statische und quasistatische Belastungen	M8 bis M24 (HST und HST-R) M8 bis M16 (HST-HCR) Tabelle : C1, C3, C5
Seismische Leistungskategorie C1/C2	M10 bis M16 (HST und HST-R) Tabelle : C7, C9, C11, C12, C15, C16
Statische und quasistatische Belastungen unter Brandbeanspruchung	M8 bis M24 Tabelle : C19, C21

**Tabelle B7: Übersicht der Leistungskategorien HST3 und HST3-R**

Beanspruchung:	HST3, HST3-R
Statische und quasistatische Belastungen	M10 bis M16 (für $h_{ef,1}$ ) M8 bis M24 (für $h_{ef,2}$ ) Tabelle : C2, C4, C6
Seismische Leistungskategorie C1/C2	M8 bis M20 (für $h_{ef,2}$ ) M12 (für $h_{ef,1}$ ) Tabelle : C8, C10, C13, C14, C17, C18
Statische und quasistatische Belastungen unter Brandbeanspruchung	M10 bis M16 (für $h_{ef,1}$ ) M8 bis M24 (für $h_{ef,2}$ ) Tabelle : C20, C22

Hilti Metallspreizanker HST, HST-R, HST-HCR, HST3, HST3-R

Angaben zum Verwendungszweck

Anhang B3

**Tabelle B8: Montagekennwerte für HST, HST-R und HST-HCR**

HST, HST-R, HST-HCR			M8	M10	M12	M16	M20 <sup>1)</sup>	M24 <sup>1)</sup>
Bohrernennendurchmesser	$d_0$	[mm]	8	10	12	16	20	24
Bohrschneidendurchmesser	$d_{cut} \leq$	[mm]	8,45	10,45	12,50	16,50	20,55	24,55
Bohrlochtiefe	$h_1 \geq$	[mm]	65	80	95	115	140	170
Effektive Verankerungstiefe	$h_{ef}$	[mm]	47	60	70	82	101	125
Nominelle Verankerungstiefe	$h_{nom}$	[mm]	55	69	80	95	117	143
Maximales Durchgangsloch im Anbauteil <sup>2)</sup>	$d_f$	[mm]	9	12	14	18	22	26
Installationsdrehmoment	$T_{inst}$	[Nm]	20	45	60	110	240	300
Maximale Anbauteilhöhe	$t_{fix,max} \leq$	[mm]	195	200	200	235	305	330
Schlüsselweite	SW	[mm]	13	17	19	24	30	36

<sup>1)</sup> Nur HST und HST-R

<sup>2)</sup> Für die Bemessung größerer Durchgangslöcher im anzuschließenden Bauteil siehe EN 1992-4:2018

**Hilti Metallspreizanker HST, HST-R, HST-HCR, HST3, HST3-R**

**Angaben zum Verwendungszweck**  
Montagekennwerte

**Anhang B4**

**Tabelle B9: Montagekennwerte für HST3 und HST3-R**

HST3, HST3-R			M8	M10	M12	M16	M20	M24
Bohrerinnendurchmesser	$d_0$	[mm]	8	10	12	16	20	24
Bohrschneidendurchmesser	$d_{cut} \leq$	[mm]	8,45	10,45	12,50	16,50	20,55	24,55
Bohrlochtiefe <sup>1)</sup>	$h_{1,1} \geq$	[mm]	-	53	68	86	-	-
Effektive Verankerungstiefe	$h_{ef,1}$	[mm]	-	40	50	65	-	-
Nominelle Verankerungstiefe	$h_{nom,1}$	[mm]	-	48	60	78	-	-
Bohrlochtiefe <sup>1)</sup>	$h_{1,2} \geq$	[mm]	59	73	88	106	124	151
Effektive Verankerungstiefe	$h_{ef,2}$	[mm]	47	60	70	85	101	125
Nominelle Verankerungstiefe	$h_{nom,2}$	[mm]	54	68	80	98	116	143
Maximales Durchgangsloch im Anbauteil <sup>2)</sup>	$d_f$	[mm]	9	12	14	18	22	26
Installationsdrehmoment	$T_{inst}$	[Nm]	20	45	60	110	180	300
Maximale Anbauteilhöhe	$t_{fix,max}$	[mm]	195	220	270	370	310	330
Schlüsselweite	SW	[mm]	13	17	19	24	30	36

<sup>1)</sup> Bei Verwendung des Diamantbohrverfahrens + 5 mm für M8 bis M10 und + 2 mm für M12 bis M24

<sup>2)</sup> Für die Bemessung größerer Durchgangslöcher im anzuschließenden Bauteil siehe EN 1992-4:2018

**Hilti Metallspreizanker HST, HST-R, HST-HCR, HST3, HST3-R**

**Angaben zum Verwendungszweck**  
Montagekennwerte

**Anhang B5**



### HST, HST-R und HST-HCR

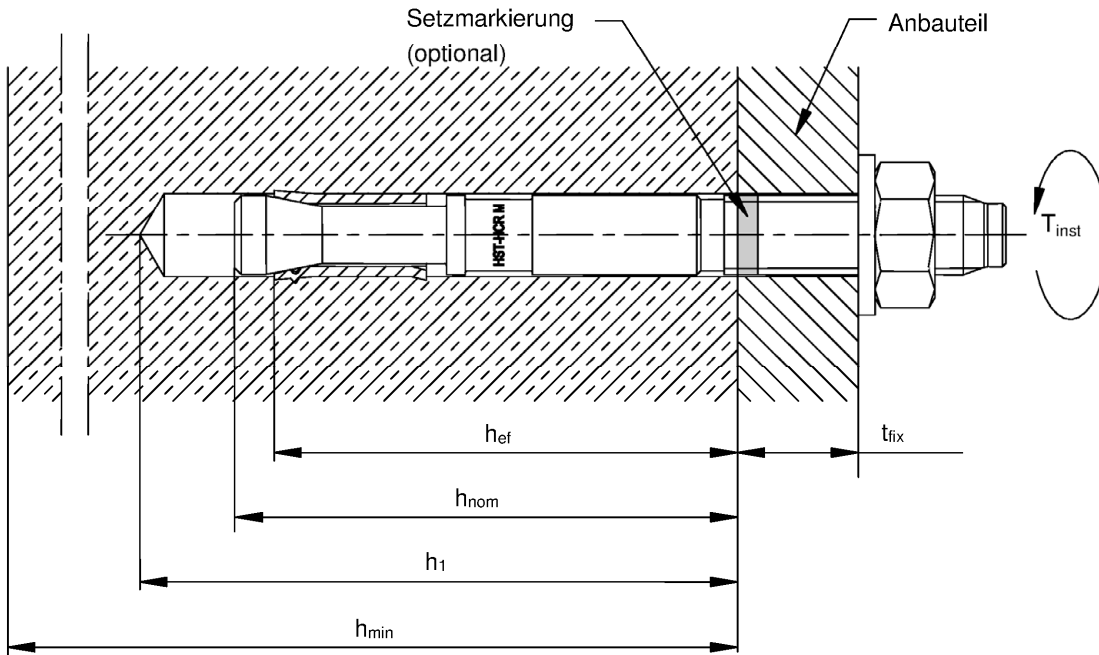

### HST3 und HST3-R (Standardeinbindetiefe)

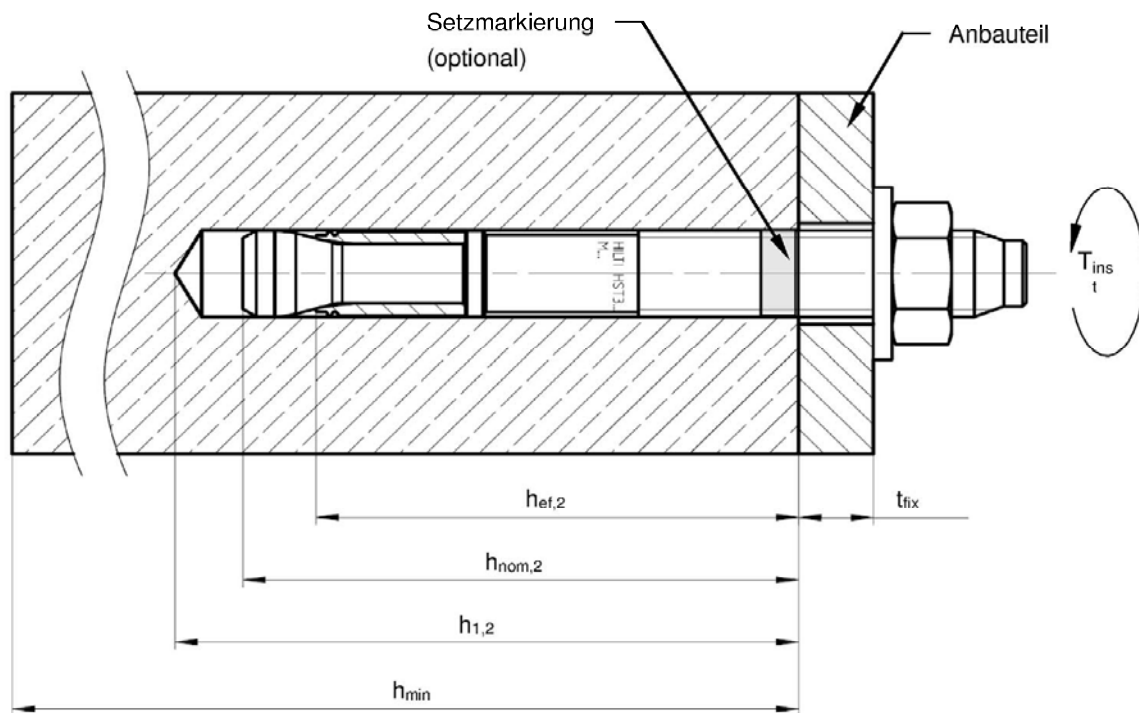

Hilti Metallspreizanker HST, HST-R, HST-HCR, HST3, HST3-R

Angaben zum Verwendungszweck  
Montagekennwerte

Anhang B6

### HST3 und HST3-R (verkürzte Einbindetiefe)

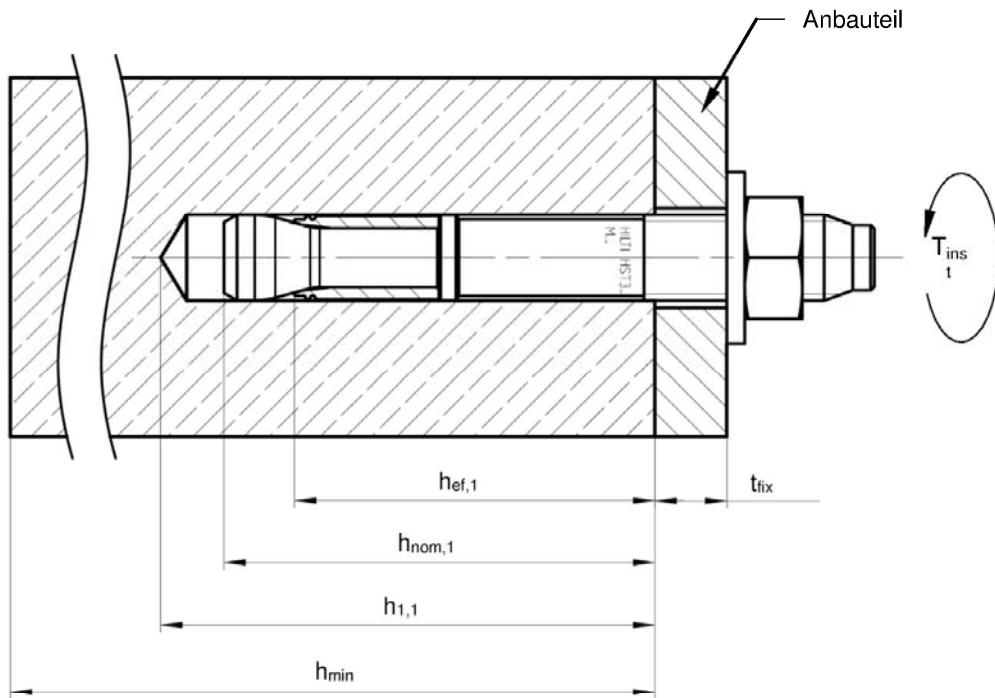

### HST3 und HST3-R mit Verfüll-Set zum Verfüllen des Ringspalts zwischen Anker und Anbauteil

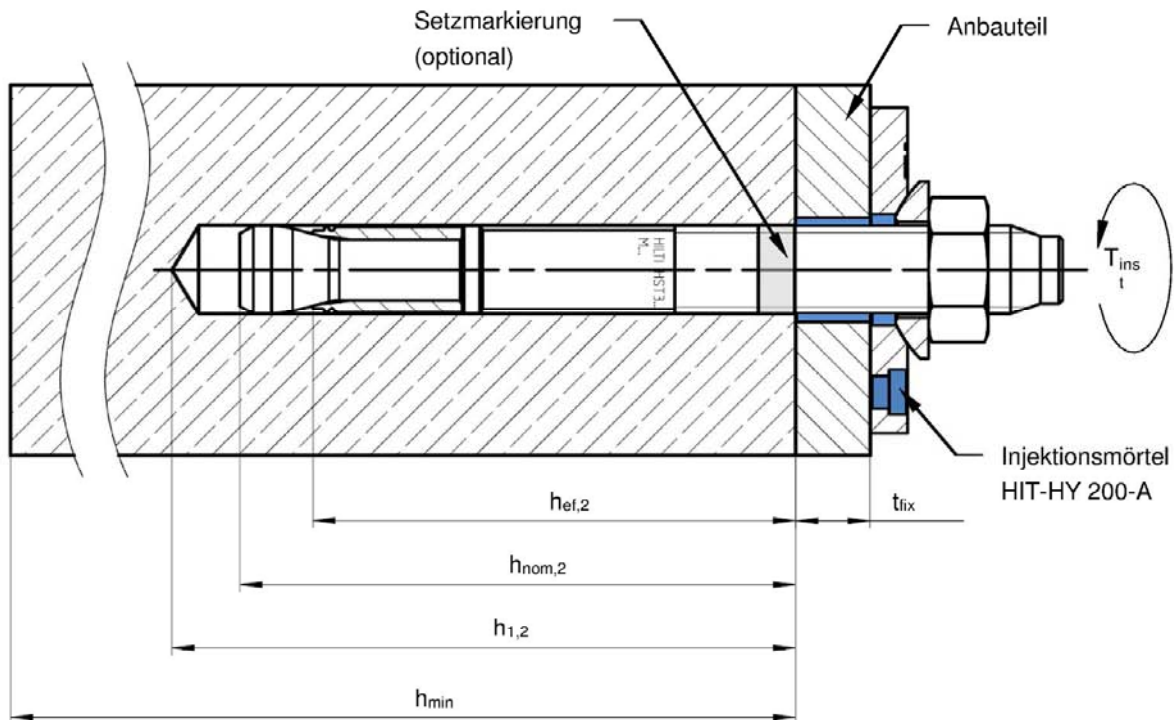

Hilti Metallspreizanker HST, HST-R, HST-HCR, HST3, HST3-R

Angaben zum Verwendungszweck  
Montagekennwerte

Anhang B7

**Tabelle B10: Minimale Achs- und Randabstände für HST, HST-R und HST-HCR**

		M8	M10	M12	M16	M20 <sup>1)</sup>	M24 <sup>1)</sup>
Mindestbauteildicke	$h_{min}$ [mm]	100	120	140	160	200	250
Effektive Verankerungstiefe	$h_{ef}$ [mm]	47	60	70	82	101	125
<b>Gerissener Beton</b>							
<b>HST</b>							
Mindestachsabstand <sup>2)</sup>	$s_{min}$ [mm]	40	55	60	70	100	125
	für $c \geq$ [mm]	50	70	75	100	160	180
Mindestrandabstand <sup>2)</sup>	$c_{min}$ [mm]	45	55	55	70	100	125
	für $s \geq$ [mm]	50	90	120	150	225	240
<b>HST-R</b>							
Mindestachsabstand <sup>2)</sup>	$s_{min}$ [mm]	40	55	60	70	100	125
	für $c \geq$ [mm]	50	65	75	100	130	130
Mindestrandabstand <sup>2)</sup>	$c_{min}$ [mm]	45	50	55	60	100	125
	für $s \geq$ [mm]	50	90	110	160	160	140
<b>HST-HCR</b>							
Mindestachsabstand <sup>2)</sup>	$s_{min}$ [mm]	40	55	60	70	<sup>3)</sup>	<sup>3)</sup>
	für $c \geq$ [mm]	50	70	75	100	<sup>3)</sup>	<sup>3)</sup>
Mindestrandabstand <sup>2)</sup>	$c_{min}$ [mm]	45	50	55	60	<sup>3)</sup>	<sup>3)</sup>
	für $s \geq$ [mm]	50	90	110	160	<sup>3)</sup>	<sup>3)</sup>

<sup>1)</sup> Nur HST und HST-R

<sup>2)</sup> Lineare Interpolation für  $s_{min}$  und  $c_{min}$  zulässig

<sup>3)</sup> Leistung nicht bewertet

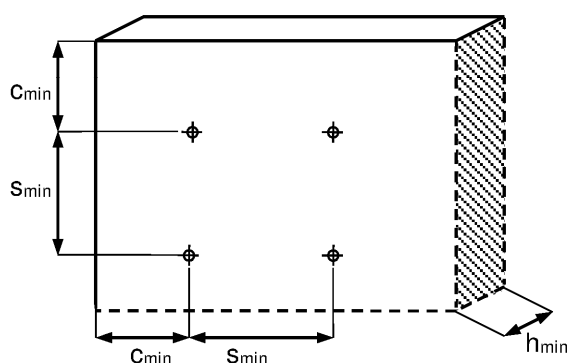

**Hilti Metallspreizanker HST, HST-R, HST-HCR, HST3, HST3-R**

**Angaben zum Verwendungszweck**  
Minimale Achs- und Randabstände

**Anhang B8**

**Tabelle B10 fortgesetzt**

		<b>M8</b>	<b>M10</b>	<b>M12</b>	<b>M16</b>	<b>M20 <sup>1)</sup></b>	<b>M24 <sup>1)</sup></b>
Mindestbauteildicke	$h_{min}$ [mm]	100	120	140	160	200	250
Effektive Verankerungstiefe	$h_{ef}$ [mm]	47	60	70	82	101	125
<b>Ungerissener Beton</b>							
<b>HST</b>							
Mindestachsabstand <sup>2)</sup>	$s_{min}$ [mm]	60	55	60	70	100	125
	für $c \geq$ [mm]	50	80	85	110	225	255
Mindestrandabstand <sup>2)</sup>	$c_{min}$ [mm]	50	55	55	85	140	170
	für $s \geq$ [mm]	60	115	145	150	270	295
<b>HST-R</b>							
Mindestachsabstand <sup>2)</sup>	$s_{min}$ [mm]	60	55	60	70	100	125
	für $c \geq$ [mm]	60	70	80	110	195	205
Mindestrandabstand <sup>2)</sup>	$c_{min}$ [mm]	60	50	55	70	140	150
	für $s \geq$ [mm]	60	115	145	160	210	235
<b>HST-HCR</b>							
Mindestachsabstand <sup>2)</sup>	$s_{min}$ [mm]	60	55	60	70	<sup>3)</sup>	<sup>3)</sup>
	für $c \geq$ [mm]	50	70	80	110	<sup>3)</sup>	<sup>3)</sup>
Mindestrandabstand <sup>2)</sup>	$c_{min}$ [mm]	60	55	55	70	<sup>3)</sup>	<sup>3)</sup>
	für $s \geq$ [mm]	60	115	145	160	<sup>3)</sup>	<sup>3)</sup>

<sup>1)</sup> Nur HST und HST-R

<sup>2)</sup> Lineare Interpolation für  $s_{min}$  und  $c_{min}$  zulässig

<sup>3)</sup> Leistung nicht bewertet

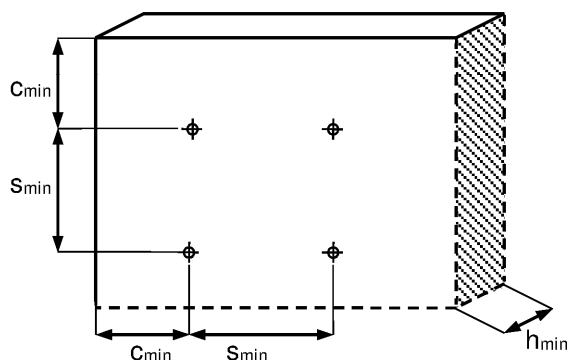

**Hilti Metallspreizanker HST, HST-R, HST-HCR, HST3, HST3-R**

**Angaben zum Verwendungszweck**  
Minimale Achs- und Randabstände

**Anhang B9**

**Tabelle B11: Minimale Achs- und Randabstände für HST3 und HST3-R**

		M8	M10	M12	M16	M20	M24
Mindestbauteildicke	$h_{min}$ [mm]	100	120	140	160	200	250
Effektive Verankerungstiefe	$h_{ef,2}$ [mm]	47	60	70	85	101	125
<b>Gerissener Beton</b>							
<b>HST3</b>							
Mindestachsabstand <sup>1)</sup>	$s_{min}$ [mm]	35	40	50	65	90	125
	für $c \geq$ [mm]	50	55	70	95	130	180
Mindestrandabstand <sup>1)</sup>	$c_{min}$ [mm]	40	45	55	65	80	125
	für $s \geq$ [mm]	50	80	110	150	180	240
<b>HST3-R</b>							
Mindestachsabstand <sup>1)</sup>	$s_{min}$ [mm]	35	40	50	65	90	125
	für $c \geq$ [mm]	50	55	70	95	130	130
Mindestrandabstand <sup>1)</sup>	$c_{min}$ [mm]	40	45	55	65	80	125
	für $s \geq$ [mm]	50	80	110	150	180	140

<sup>1)</sup> Lineare Interpolation für  $s_{min}$  und  $c_{min}$  zulässig

<sup>2)</sup> Leistung nicht bewertet

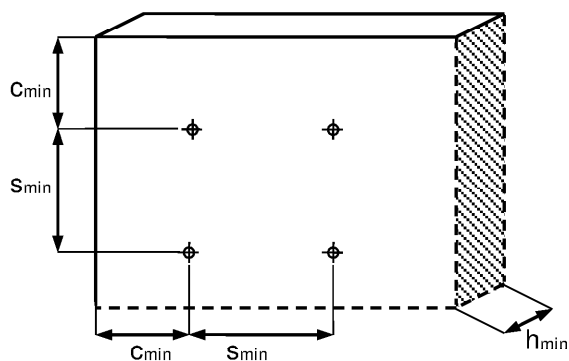

**Hilti Metallspreizanker HST, HST-R, HST-HCR, HST3, HST3-R**

**Angaben zum Verwendungszweck**  
Minimale Achs- und Randabstände

**Anhang B10**

**Tabelle B11 fortgesetzt**

		M8	M10	M12	M16	M20	M24
Mindestbauteildicke	$h_{min}$ [mm]	100	120	140	160	200	250
Effektive Verankerungstiefe	$h_{ef,2}$ [mm]	47	60	70	85	101	125
<b>Ungerissener Beton</b>							
<b>HST3</b>							
Mindestachsabstand <sup>1)</sup>	$s_{min}$ [mm]	35	40	60	65	90	125
	für $c \geq$ [mm]	50	60	70	95	130	255
Mindestrandabstand <sup>1)</sup>	$c_{min}$ [mm]	40	50	55	65	80	170
	für $s \geq$ [mm]	50	90	110	150	180	295
<b>HST3-R</b>							
Mindestachsabstand <sup>1)</sup>	$s_{min}$ [mm]	35	40	60	65	90	125
	für $c \geq$ [mm]	50	60	70	95	130	205
Mindestrandabstand <sup>1)</sup>	$c_{min}$ [mm]	40	50	55	65	80	150
	für $s \geq$ [mm]	50	90	110	150	180	235

<sup>1)</sup> Lineare Interpolation für  $s_{min}$  und  $c_{min}$  zulässig

<sup>2)</sup> Leistung nicht bewertet

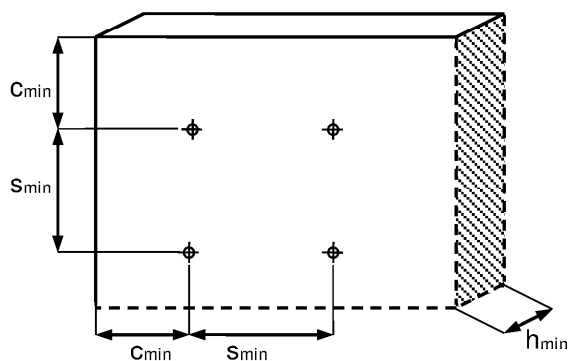

**Hilti Metallspreizanker HST, HST-R, HST-HCR, HST3, HST3-R**

**Angaben zum Verwendungszweck**  
Minimale Achs- und Randabstände

**Anhang B11**

**Tabelle B11 fortgesetzt**

		M8	M10	M12	M16	M20	M24
Mindestbauteildicke	$h_{min}$ [mm]	80	100	120	140	160	2)
Effektive Verankerungstiefe	$h_{ef,2}$ [mm]	47	60	70	85	101	2)
<b>Gerissener Beton</b>							
<b>HST3 und HST3-R</b>							
Mindestachsabstand <sup>1)</sup>	$s_{min}$ [mm]	35	40	50	80	120	2)
	für $c \geq$ [mm]	50	100	90	130	180	2)
Mindestrandabstand <sup>1)</sup>	$c_{min}$ [mm]	40	60	60	65	120	2)
	für $s \geq$ [mm]	50	90	120	180	180	2)
<b>Ungerissener Beton</b>							
<b>HST3 und HST3-R</b>							
Mindestachsabstand <sup>1)</sup>	$s_{min}$ [mm]	35	40	50	80	120	2)
	für $c \geq$ [mm]	55	100	100	130	180	2)
Mindestrandabstand <sup>1)</sup>	$c_{min}$ [mm]	40	60	60	65	120	2)
	für $s \geq$ [mm]	60	90	120	180	180	2)

<sup>1)</sup> Lineare Interpolation für  $s_{min}$  und  $c_{min}$  zulässig

<sup>2)</sup> Leistung nicht bewertet

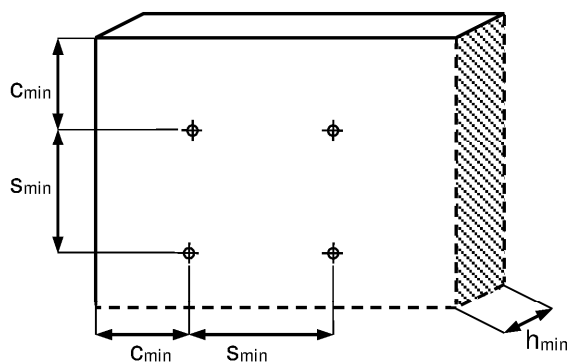

**Hilti Metallspreizanker HST, HST-R, HST-HCR, HST3, HST3-R**

**Angaben zum Verwendungszweck**  
Minimale Achs- und Randabstände

**Anhang B12**

**Tabelle B11 fortgesetzt**

		M8	M10	M12	M16	M20	M24
Mindestbauteildicke	$h_{min}$ [mm]	2)	80	100	120	2)	2)
Effektive Verankerungstiefe	$h_{ef,1}$ [mm]	2)	40	50	65	2)	2)
<b>Gerissener Beton</b>							
<b>HST3 und HST3-R</b>							
Mindestachsabstand <sup>1)</sup>	$s_{min}$ [mm]	2)	40	50	65	2)	2)
	für $c \geq$ [mm]	2)	90	105	130	2)	2)
Mindestrandabstand <sup>1)</sup>	$c_{min}$ [mm]	2)	45	55	65	2)	2)
	für $s \geq$ [mm]	2)	180	210	240	2)	2)
<b>Ungerissener Beton</b>							
<b>HST3 und HST3-R</b>							
Mindestachsabstand <sup>1)</sup>	$s_{min}$ [mm]	2)	50	55	75	2)	2)
	für $c \geq$ [mm]	2)	95	110	140	2)	2)
Mindestrandabstand <sup>1)</sup>	$c_{min}$ [mm]	2)	50	60	65	2)	2)
	für $s \geq$ [mm]	2)	190	215	240	2)	2)

<sup>1)</sup> Lineare Interpolation für  $s_{min}$  und  $c_{min}$  zulässig

<sup>2)</sup> Leistung nicht bewertet

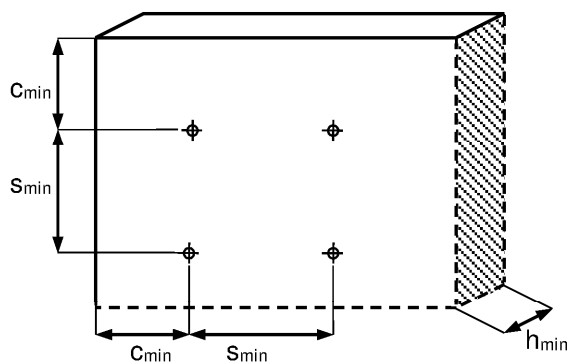

**Hilti Metallspreizanker HST, HST-R, HST-HCR, HST3, HST3-R**

**Angaben zum Verwendungszweck**  
Minimale Achs- und Randabstände

**Anhang B13**



## Montageanweisung HST, HST-R und HST-HCR

### Bohrlocherstellung und Bohrlochreinigung

- a) Hammerbohren (HD):  
M8 bis M24

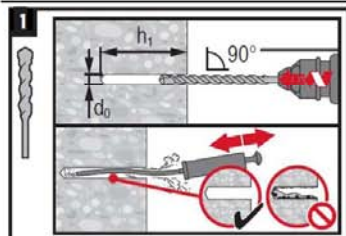

### Setzen des Metallspreizankers

- a) Hammersetzen:  
M8 bis M24



- b) Maschinensetzen (Setzwerkzeug):  
M8 bis M24

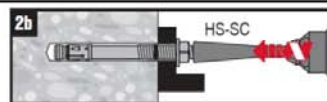

### Kontrolle der Setzung

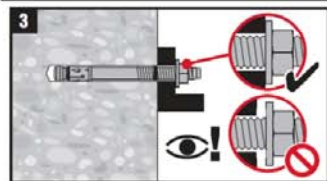

### Anziehen des Metallspreizankers

- a) Drehmomentschlüssel:  
M8 bis M24

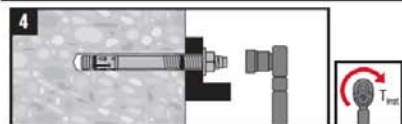

Hilti Metallspreizanker HST, HST-R, HST-HCR, HST3, HST3-R

Angaben zum Verwendungszweck  
Montageanweisung

Anhang B14

## Montageanweisung HST3 und HST3-R

### Bohrlocherstellung und Bohrlochreinigung

a) Hammerbohren (HD):  
M8 bis M24

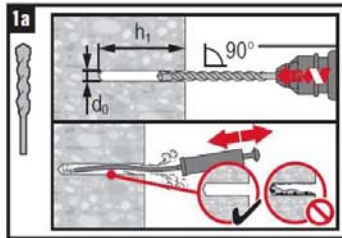

b) Diamantbohrverfahren (DD):  
M8 bis M24

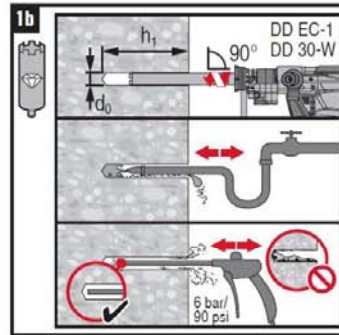

c) Hammerbohren mit Hilti  
Hohlbohrern (HDB):  
M12 bis M24

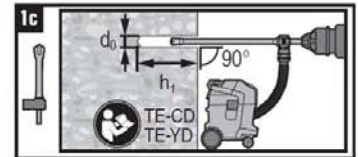

### Setzen des Metallspreizankers

a) Hammersetzen:



b) Maschinensetzen (Setzwerkzeug):

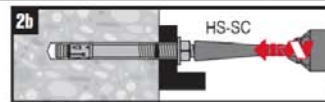

### Kontrolle der Setzung

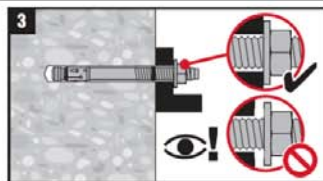

### Anziehen des Metallspreizankers

a) Drehmomentschlüssel:  
M8 bis M24

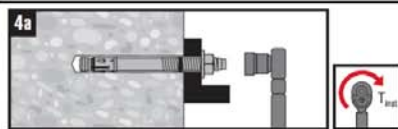

b) Maschinenanzug:  
M8 bis M12

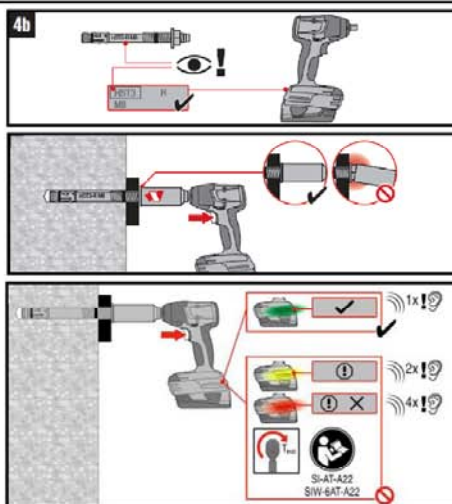

Hilti Metallspreizanker HST, HST-R, HST-HCR, HST3, HST3-R

Angaben zum Verwendungszweck  
Montageanweisung

Anhang B15

## Montageanweisung HST3 und HST3-R mit Verfüll-Set

### Montage Verfüll-Set

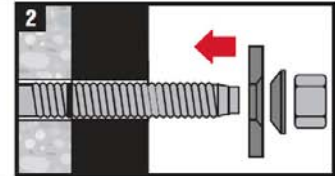
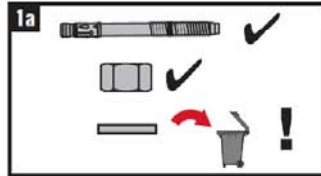

### Anziehen des Metallspreizankers

a) Drehmomentschlüssel:  
M8 bis M20

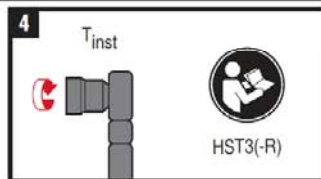
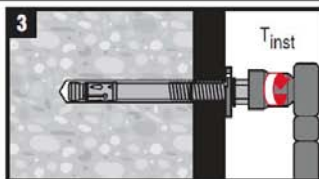

### Montage der Kontermutter

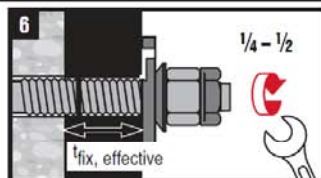
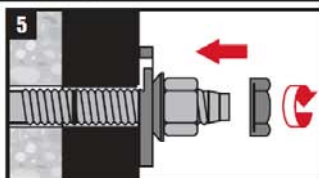

### Mörtelinjektion

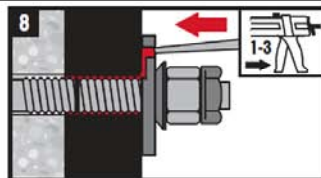

Hilti Metallspreizanker HST, HST-R, HST-HCR, HST3, HST3-R

Angaben zum Verwendungszweck  
Montageanweisung

Anhang B16

**Tabelle C1: Charakteristische Werte der Zugtragfähigkeit für Hilti Metallspreizanker HST, HST-R und HST-HCR im gerissenen und ungerissenen Beton**

			M8	M10	M12	M16	M20 <sup>1)</sup>	M24 <sup>1)</sup>
<b>Stahlversagen</b>								
<b>HST</b>								
Charakteristische Zugtragfähigkeit	$N_{Rk,s}$	[kN]	19,0	32,0	45,0	76,0	117,0	127,0
Teilsicherheitsbeiwert	$\gamma_{Ms}$ <sup>2)</sup>	[-]	1,50					1,41
<b>HST-R</b>								
Charakteristische Zugtragfähigkeit	$N_{Rk,s}$	[kN]	17,0	28,0	40,0	69,0	109,0	156,0
Teilsicherheitsbeiwert	$\gamma_{Ms}$ <sup>2)</sup>	[-]	1,50			1,56	1,73	
<b>HST-HCR</b>								
Charakteristische Zugtragfähigkeit	$N_{Rk,s}$	[kN]	19,4	32,3	45,7	84,5	3)	3)
Teilsicherheitsbeiwert	$\gamma_{Ms}$ <sup>2)</sup>	[-]	1,50				3)	3)
<b>Herausziehen</b>								
<b>HST</b>								
Charakteristische Zugtragfähigkeit im gerissenen Beton C20/25	$N_{Rk,p}$	[kN]	5,0	9,0	12,0	20,0	30,0	40,0
Charakteristische Zugtragfähigkeit im ungerissenen Beton C20/25	$N_{Rk,p}$	[kN]	9,0	16,0	20,0	35,0	50,0	60,0
Montagesicherheitsbeiwert	$\gamma_{inst}$	[-]	1,20	1,00				
<b>HST-R</b>								
Charakteristische Zugtragfähigkeit im gerissenen Beton C20/25	$N_{Rk,p}$	[kN]	5,0	9,0	12,0	25,0	30,0	40,0
Charakteristische Zugtragfähigkeit im ungerissenen Beton C20/25	$N_{Rk,p}$	[kN]	9,0	16,0	20,0	35,0	50,0	60,0
Montagesicherheitsbeiwert	$\gamma_{inst}$	[-]	1,00					
<b>HST-HCR</b>								
Charakteristische Zugtragfähigkeit im gerissenen Beton C20/25	$N_{Rk,p}$	[kN]	5,0	9,0	12,0	25,0	3)	3)
Charakteristische Zugtragfähigkeit im ungerissenen Beton C20/25	$N_{Rk,p}$	[kN]	9,0	16,0	20,0	35,0	3)	3)
Montagesicherheitsbeiwert	$\gamma_{inst}$	[-]	1,00				3)	3)

<sup>1)</sup> Nur HST und HST-R

<sup>2)</sup> Sofern andere nationale Regelungen fehlen

<sup>3)</sup> Leistung nicht bewertet

**Hilti Metallspreizanker HST, HST-R, HST-HCR, HST3, HST3-R**

**Leistungsfähigkeit**

Charakteristische Werte der Zugtragfähigkeit im gerissenen und ungerissenen Beton

**Anhang C1**

**Tabelle C1 fortgesetzt**

			M8	M10	M12	M16	M20 <sup>1)</sup>	M24 <sup>1)</sup>
<b>Herausziehen</b>								
<b>HST, HST-R und HST-HCR</b>								
Erhöhungsfaktoren für gerissenen und ungerissenen Beton	$\psi_c$	C20/25	1,00					
	$\psi_c$	C30/37	1,22					
	$\psi_c$	C40/50	1,41					
	$\psi_c$	C50/60	1,55					
<b>Betonausbruch und Spalten</b>								
<b>HST, HST-R und HST-HCR</b>								
Effektive Verankerungstiefe	$h_{ef}$	[mm]	47	60	70	82	101	125
Montagesicherheitsbeiwert	$\gamma_{inst}$	[-]	1,20	1,00				
Faktor für gerissenen Beton	$k_{cr,N}$	[-]	7,7					
Faktor für ungerissenen Beton	$k_{ucr,N}$	[-]	11,0					
Charakteristische Spalttragfähigkeit im ungerissenen Beton C20/25	$N^0_{Rk,sp}$	[kN]	9,0	16,0	20,0	35,0	50,0	60,0
Achsabstand	$s_{cr,N}$ $s_{cr,sp}$	[mm]	3 $h_{ef}$					
Randabstand	$c_{cr,N}$ $c_{cr,sp}$	[mm]	1,5 $h_{ef}$					

<sup>1)</sup> Nur HST und HST-R

<sup>2)</sup> Sofern andere nationale Regelungen fehlen

<sup>3)</sup> Leistung nicht bewertet

**Hilti Metallspreizanker HST, HST-R, HST-HCR, HST3, HST3-R**

**Leistungsfähigkeit**

Charakteristische Werte der Zugtragfähigkeit im gerissenen und ungerissenen Beton

**Anhang C2**

**Tabelle C2: Charakteristische Werte der Zugtragfähigkeit für Hilti Metallspreizanker HST3 und HST3-R im gerissenen und ungerissenen Beton**

			M8	M10	M12	M16	M20	M24
<b>Stahlversagen</b>								
<b>HST3</b>								
Charakteristische Zugtragfähigkeit	$N_{Rk,s}$	[kN]	19,7	32,5	45,1	76,0	124,2	127,0
Teilsicherheitsbeiwert	$\gamma_{Ms}^{1)}$	[-]	1,40					1,41
<b>HST3-R</b>								
Charakteristische Zugtragfähigkeit	$N_{Rk,s}$	[kN]	17,7	28,7	42,5	69,4	115,8	156,0
Teilsicherheitsbeiwert	$\gamma_{Ms}^{1)}$	[-]	1,40					1,56
<b>Herausziehen</b>								
<b>HST3</b>								
Effektive Verankerungstiefe	$h_{ef,2}$	[mm]	47	60	70	85	101	125
Charakteristische Zugtragfähigkeit im gerissenen Beton C20/25	$N_{Rk,p}$	[kN]	8,0	15,0	20,0	27,0	35,0	40,0
Charakteristische Zugtragfähigkeit im ungerissenen Beton C20/25	$N_{Rk,p}$	[kN]	12,0	22,0	25,0	38,6	49,9	60,0
Montagesicherheitsbeiwert	$\gamma_{inst}$	[-]	1,00					
<b>HST3-R</b>								
Effektive Verankerungstiefe	$h_{ef,2}$	[mm]	47	60	70	85	101	125
Charakteristische Zugtragfähigkeit im gerissenen Beton C20/25	$N_{Rk,p}$	[kN]	8,5	15,0	20,0	27,0	35,0	40,0
Charakteristische Zugtragfähigkeit im ungerissenen Beton C20/25	$N_{Rk,p}$	[kN]	12,0	22,0	25,0	38,6	49,9	60,0
Montagesicherheitsbeiwert	$\gamma_{inst}$	[-]	1,00					
<b>HST3 und HST3-R</b>								
Effektive Verankerungstiefe	$h_{ef,1}$	[mm]	2)	40	50	65	2)	2)
Charakteristische Zugtragfähigkeit im gerissenen Beton C20/25	$N_{Rk,p}$	[kN]	2)	8,7	12,2	18,0	2)	2)
Charakteristische Zugtragfähigkeit im ungerissenen Beton C20/25	$N_{Rk,p}$	[kN]	2)	12,4	17,4	25,8	2)	2)
Montagesicherheitsbeiwert	$\gamma_{inst}$	[-]	1,00					

1) Sofern andere nationale Regelungen fehlen

2) Leistung nicht bewertet

**Hilti Metallspreizanker HST, HST-R, HST-HCR, HST3, HST3-R**

**Leistungsfähigkeit**

Charakteristische Werte der Zugtragfähigkeit im gerissenen und ungerissenen Beton

**Anhang C3**

**Tabelle C2 fortgesetzt**

			M8	M10	M12	M16	M20	M24	
<b>Herausziehen</b>									
<b>HST3 und HST3-R</b>									
Erhöhungsfaktoren für gerissenen und ungerissenen Beton	$\Psi_c$	C20/25	1,00						
	$\Psi_c$	C30/37	1,22						
	$\Psi_c$	C40/50	1,41						
	$\Psi_c$	C50/60	1,55						
<b>Betonausbruch und Spalten</b>									
<b>HST3 und HST3-R</b>									
Effektive Verankerungstiefe	$h_{ef,2}$	[mm]	47	60	70	85	101	125	
Montagesicherheitsbeiwert	$\gamma_{inst}$	[-]	1,00						
Faktor für gerissenen Beton	$k_{cr,N}$	[-]	7,7						
Faktor für ungerissenen Beton	$k_{ucr,N}$	[-]	11,0						
Charakteristische Spalttragfähigkeit im ungerissenen Beton C20/25	$N^0_{RK,sp}$	[kN]	12,0	22,0	25,0	38,6	49,9	60,0	
Achsabstand	$s_{cr,N}$	[mm]	3 $h_{ef}$						
Randabstand	$c_{cr,N}$	[mm]	1,5 $h_{ef}$						
Achsabstand	$s_{cr,sp}$	[mm]	3 $h_{ef}$				3,8 $h_{ef}$	3 $h_{ef}$	
Randabstand	$c_{cr,sp}$	[mm]	1,5 $h_{ef}$				1,9 $h_{ef}$	1,5 $h_{ef}$	
<b>HST3 und HST3-R</b>									
Effektive Verankerungstiefe	$h_{ef,1}$	[mm]	2)	40	50	65	2)	2)	
Montagesicherheitsbeiwert	$\gamma_{inst}$	[-]	2)	1,00			2)	2)	
Faktor für gerissenen Beton	$k_{cr,N}$	[-]	2)	7,7			2)	2)	
Faktor für ungerissenen Beton	$k_{ucr,N}$	[-]	2)	11,0			2)	2)	
Charakteristische Spalttragfähigkeit im ungerissenen Beton C20/25	$N^0_{RK,sp}$	[kN]	2)	12,4	17,4	25,8	2)	2)	
Achsabstand	$s_{cr,N}$	[mm]	2)	3 $h_{ef}$			2)	2)	
Randabstand	$c_{cr,N}$	[mm]	2)	1,5 $h_{ef}$			2)	2)	
Achsabstand	$s_{cr,sp}$	[mm]	2)	4,2 $h_{ef}$	3,6 $h_{ef}$	3,2 $h_{ef}$	2)	2)	
Randabstand	$c_{cr,sp}$	[mm]	2)	2,1 $h_{ef}$	1,8 $h_{ef}$	1,6 $h_{ef}$	2)	2)	

1) Sofern andere nationale Regelungen fehlen

2) Leistung nicht bewertet

**Hilti Metallspreizanker HST, HST-R, HST-HCR, HST3, HST3-R**

**Leistungsfähigkeit**

Charakteristische Werte der Zugtragfähigkeit im gerissenen und ungerissenen Beton

**Anhang C4**



**Tabelle C3: Charakteristischer Widerstand bei Querlast für Hilti Metallspreizanker HST, HST-R und HST-HCR im gerissenen und ungerissenen Beton**

			M8	M10	M12	M16	M20 <sup>1)</sup>	M24 <sup>1)</sup>
<b>Stahlbruch, Querlast ohne Hebelarm</b>								
<b>HST</b>								
Charakteristischer Widerstand	$V_{Rk,s}^0$	[kN]	14,0	23,5	35,0	55,0	84,0	94,0
Teilsicherheitsbeiwert	$\gamma_{Ms}^{2)}$	[-]	1,25					1,50
Duktilitätsfaktor	$k_7$	[-]	1,00					
<b>HST-R</b>								
Charakteristischer Widerstand	$V_{Rk,s}^0$	[kN]	13,0	20,0	30,0	50,0	80,0	115,0
Teilsicherheitsbeiwert	$\gamma_{Ms}^{2)}$	[-]	1,25			1,30	1,44	
Duktilitätsfaktor	$k_7$	[-]	1,00					
<b>HST-HCR</b>								
Charakteristischer Widerstand	$V_{Rk,s}^0$	[kN]	13,0	20,0	30,0	55,0	3)	3)
Teilsicherheitsbeiwert	$\gamma_{Ms}^{2)}$	[-]	1,25				3)	3)
Duktilitätsfaktor	$k_7$	[-]	1,00				3)	3)
<b>Stahlbruch, Querlast mit Hebelarm</b>								
<b>HST</b>								
Charakteristischer Widerstand	$M_{Rk,s}^0$	[Nm]	30	60	105	240	454	595
Teilsicherheitsbeiwert	$\gamma_{Ms}^{2)}$	[-]	1,25					1,50
<b>HST-R</b>								
Charakteristischer Widerstand	$M_{Rk,s}^0$	[Nm]	27	53	92	216	422	730
Teilsicherheitsbeiwert	$\gamma_{Ms}^{2)}$	[-]	1,25			1,30	1,44	
<b>HST-HCR</b>								
Charakteristischer Widerstand	$M_{Rk,s}^0$	[Nm]	30	60	105	266	3)	3)
Teilsicherheitsbeiwert	$\gamma_{Ms}^{2)}$	[-]	1,25				3)	3)

<sup>1)</sup> Nur HST und HST-R

<sup>2)</sup> Sofern andere nationale Regelungen fehlen

<sup>3)</sup> Leistung nicht bewertet

**Hilti Metallspreizanker HST, HST-R, HST-HCR, HST3, HST3-R**

**Leistungsfähigkeit**

Charakteristische Werte der Quertragfähigkeit im gerissenen und ungerissenen Beton

**Anhang C5**



**Tabelle C3 fortgesetzt**

			M8	M10	M12	M16	M20 <sup>1)</sup>	M24 <sup>1)</sup>
<b>Betonausbruch auf der lastabgewandten Seite</b>								
<b>HST, HST-R und HST-HCR</b>								
Montagesicherheitsbeiwert	$\gamma_{inst}$	[-]	1,00					
Pryout-Faktor	$k_8$	[-]	2,0	2,0	2,2	2,5	2,5	2,5
<b>Betonkantenbruch</b>								
<b>HST, HST-R und HST-HCR</b>								
Wirksame Ankerlänge bei Querkraft	$l_f$	[mm]	47	60	70	82	101	125
Außendurchmesser	$d_{nom}$	[mm]	8	10	12	16	20	24
Montagesicherheitsbeiwert	$\gamma_{inst}$	[-]	1,00					

<sup>1)</sup> Nur HST und HST-R

<sup>2)</sup> Sofern andere nationale Regelungen fehlen

<sup>3)</sup> Leistung nicht bewertet

**Hilti Metallspreizanker HST, HST-R, HST-HCR, HST3, HST3-R**

**Leistungsfähigkeit**

Charakteristische Werte der Quertragfähigkeit im gerissenen und ungerissenen Beton

**Anhang C6**

**Tabelle C4: Charakteristischer Widerstand bei Querlast für Hilti Metallspreizanker HST3 und HST3-R im gerissenen und ungerissenen Beton**

			M8	M10	M12	M16	M20	M24
<b>Stahlbruch, Querlast ohne Hebelarm</b>								
<b>HST3</b>								
Effektive Verankerungstiefe	$h_{ef,2}$	[mm]	47	60	70	85	101	125
Charakteristischer Widerstand	$V_{Rk,s}^0$	[kN]	13,8	23,6	35,4	55,3	83,9	94,0
Charakteristischer Widerstand bei Verwendung des Ankers mit Verfüll-Set	$V_{Rk,s}^0$	[kN]	16,6	25,8	39,0	60,9	100,4	<sup>2)</sup>
Teilsicherheitsbeiwert	$\gamma_{Ms}^1$	[-]	1,25					1,50
Duktilitätsfaktor	$k_7$	[-]	1,00					
<b>HST3-R</b>								
Effektive Verankerungstiefe	$h_{ef,2}$	[mm]	47	60	70	85	101	125
Charakteristischer Widerstand	$V_{Rk,s}^0$	[kN]	15,7	25,3	36,7	63,6	97,2	115,0
Charakteristischer Widerstand bei Verwendung des Ankers mit Verfüll-Set	$V_{Rk,s}^0$	[kN]	19,5	28,4	44,3	70,2	102,7	<sup>2)</sup>
Teilsicherheitsbeiwert	$\gamma_{Ms}^1$	[-]	1,25					1,30
Duktilitätsfaktor	$k_7$	[-]	1,00					
<b>HST3</b>								
Effektive Verankerungstiefe	$h_{ef,1}$	[mm]	<sup>2)</sup>	40	50	65	<sup>2)</sup>	<sup>2)</sup>
Charakteristischer Widerstand	$V_{Rk,s}^0$	[kN]	<sup>2)</sup>	21,9	34,0	54,5	<sup>2)</sup>	<sup>2)</sup>
Teilsicherheitsbeiwert	$\gamma_{Ms}^1$	[-]	<sup>2)</sup>	1,25			<sup>2)</sup>	<sup>2)</sup>
Duktilitätsfaktor	$k_7$	[-]	<sup>2)</sup>	1,00			<sup>2)</sup>	<sup>2)</sup>
<b>HST3-R</b>								
Effektive Verankerungstiefe	$h_{ef,1}$	[mm]	<sup>2)</sup>	40	50	65	<sup>2)</sup>	<sup>2)</sup>
Charakteristischer Widerstand	$V_{Rk,s}^0$	[kN]	<sup>2)</sup>	25,6	31,1	48,6	<sup>2)</sup>	<sup>2)</sup>
Teilsicherheitsbeiwert	$\gamma_{Ms}^1$	[-]	<sup>2)</sup>	1,25			<sup>2)</sup>	<sup>2)</sup>
Duktilitätsfaktor	$k_7$	[-]	<sup>2)</sup>	1,00			<sup>2)</sup>	<sup>2)</sup>

<sup>1)</sup> Sofern andere nationale Regelungen fehlen

<sup>2)</sup> Leistung nicht bewertet

**Hilti Metallspreizanker HST, HST-R, HST-HCR, HST3, HST3-R**

**Leistungsfähigkeit**

Charakteristische Werte der Quertragfähigkeit im gerissenen und ungerissenen Beton

**Anhang C7**

**Tabelle C4 fortgesetzt**

		M8	M10	M12	M16	M20	M24	
<b>Stahlbruch, Querlast mit Hebelarm</b>								
<b>HST3</b>								
Charakteristischer Widerstand	$M^0_{Rk,s}$ [Nm]	30	60	105	240	457	595	
Teilsicherheitsbeiwert	$\gamma_{Ms}^{1)}$ [-]	1,25					1,50	
<b>HST3-R</b>								
Charakteristischer Widerstand	$M^0_{Rk,s}$ [Nm]	27	53	93	216	425	730	
Teilsicherheitsbeiwert	$\gamma_{Ms}^{1)}$ [-]	1,25					1,30	
<b>Betonausbruch auf der lastabgewandten Seite</b>								
<b>HST3 und HST3-R</b>								
Effektive Verankerungslänge	$h_{ef,2}$ [mm]	47	60	70	85	101	125	
Montagesicherheitsbeiwert	$\gamma_{inst}$ [-]	1,00						
Pryout-Faktor	$k_8$ [-]	2,62	2,67	2,78	3,41	3,20	2,50	
<b>HST3 und HST3-R</b>								
Effektive Verankerungslänge	$h_{ef,1}$ [mm]	<sup>2)</sup>	40	50	65	<sup>2)</sup>	<sup>2)</sup>	
Montagesicherheitsbeiwert	$\gamma_{inst}$ [-]	1,00						
Pryout-Faktor	$k_8$ [-]	<sup>2)</sup>	2,67	2,78	3,41	<sup>2)</sup>	<sup>2)</sup>	
<b>Betonkantenbruch</b>								
<b>HST3 und HST3-R</b>								
Wirksame Ankerlänge bei Querkraft	$l_{f,2}$ [mm]	47	60	70	85	101	125	
Wirksame Ankerlänge bei Querkraft mit verkürzter Einbindetiefe	$l_{f,1}$ [mm]	<sup>2)</sup>	40	50	65	<sup>2)</sup>	<sup>2)</sup>	
Außendurchmesser	$d_{nom}$ [mm]	8	10	12	16	20	24	
Montagesicherheitsbeiwert	$\gamma_{inst}$ [-]	1,00						

<sup>1)</sup> Sofern andere nationale Regelungen fehlen

<sup>2)</sup> Leistung nicht bewertet

**Hilti Metallspreizanker HST, HST-R, HST-HCR, HST3, HST3-R**

**Leistungsfähigkeit**

Charakteristische Werte der Quertragfähigkeit im gerissenen und ungerissenen Beton

**Anhang C8**

**Tabelle C5: Verschiebungen unter Zug- und Querlast für Hilti Metallspreizanker HST, HST-R und HST-HCR für statische und quasistatische Lasten**

			M8	M10	M12	M16	M20 <sup>1)</sup>	M24 <sup>1)</sup>
<b>Verschiebungen unter Zuglast</b>								
<b>HST</b>								
Zuglast im gerissenen Beton	N	[kN]	2,0	4,3	5,7	9,5	14,3	19,0
Zugehörige Verschiebung	$\delta_{N0}$	[mm]	1,3	0,2	0,1	0,5	1,9	2,2
	$\delta_{N\infty}$	[mm]	1,2	1,0	1,2	1,2	2,3	2,5
Zuglast im ungerissenen Beton	N	[kN]	3,6	7,6	9,5	16,7	23,8	28,6
Zugehörige Verschiebung	$\delta_{N0}$	[mm]	0,2	0,1	0,1	0,4	0,6	0,5
	$\delta_{N\infty}$	[mm]	1,1	1,1	1,1	1,1	1,4	1,4
<b>HST-R und HST-HCR</b>								
Zuglast im gerissenen Beton	N	[kN]	2,4	4,3	5,7	11,9	14,3	19,0
Zugehörige Verschiebung	$\delta_{N0}$	[mm]	0,6	0,2	0,8	1,0	1,1	0,8
	$\delta_{N\infty}$	[mm]	1,5	1,2	1,4	1,2	1,2	1,7
Zuglast im ungerissenen Beton	N	[kN]	4,3	7,6	9,5	16,7	23,8	28,6
Zugehörige Verschiebung	$\delta_{N0}$	[mm]	0,1	0,1	0,1	0,1	0,5	0,8
	$\delta_{N\infty}$	[mm]	1,5	1,2	1,4	1,2	1,2	1,7
<b>Verschiebungen unter Querlast</b>								
<b>HST</b>								
Querlast im gerissenen und ungerissenen Beton	V	[kN]	8,0	13,4	20,0	31,4	48,0	45,0
Zugehörige Verschiebung	$\delta_{V0}$	[mm]	2,5	2,5	3,7	4,0	2,7	2,0
	$\delta_{V\infty}$	[mm]	3,8	3,7	5,5	6,0	4,1	3,0
<b>HST-R und HST-HCR</b>								
Querlast im gerissenen und ungerissenen Beton	V	[kN]	7,4	11,0	17,0	27,5	40,0	57,0
Zugehörige Verschiebung	$\delta_{V0}$	[mm]	1,6	3,3	4,9	2,2	2,5	2,5
	$\delta_{V\infty}$	[mm]	2,4	4,9	7,4	3,3	3,7	3,7

<sup>1)</sup> Nur HST und HST-R

**Hilti Metallspreizanker HST, HST-R, HST-HCR, HST3, HST3-R**

**Leistungsfähigkeit**  
Verschiebungen unter Zug- und Querbelastung

**Anhang C9**

**Tabelle C6: Verschiebungen unter Zug- und Querlast für Hilti Metallspreizanker HST3 und HST3-R für statische und quasistatische Lasten**

			M8	M10	M12	M16	M20	M24
<b>Verschiebungen unter Zuglast</b>								
<b>HST3</b>								
Effektive Verankerungstiefe	$h_{ef,2}$	[mm]	47	60	70	85	101	125
Zuglast im gerissenen Beton	N	[kN]	3,6	5,7	9,5	13,4	17,4	19,0
Zugehörige Verschiebung	$\delta_{N0}$	[mm]	0,6	0,6	0,8	1,8	1,3	2,2
	$\delta_{N\infty}$	[mm]	1,1	1,3	1,6	1,7	1,8	2,5
Zuglast im ungerissenen Beton	N	[kN]	5,7	9,5	11,9	18,9	24,4	28,6
Zugehörige Verschiebung	$\delta_{N0}$	[mm]	0,2	0,3	0,2	0,8	0,5	0,5
	$\delta_{N\infty}$	[mm]	0,4	0,5	0,4	1,5	0,9	1,4
<b>HST3-R</b>								
Effektive Verankerungstiefe	$h_{ef,2}$	[mm]	47	60	70	85	101	125
Zuglast im gerissenen Beton	N	[kN]	3,6	5,7	9,5	13,4	17,4	19,0
Zugehörige Verschiebung	$\delta_{N0}$	[mm]	0,6	0,6	0,8	1,8	1,3	0,8
	$\delta_{N\infty}$	[mm]	1,1	1,3	1,6	1,7	1,8	1,7
Zuglast im ungerissenen Beton	N	[kN]	5,7	9,5	11,9	18,9	24,4	28,6
Zugehörige Verschiebung	$\delta_{N0}$	[mm]	0,2	0,3	0,2	0,8	0,5	0,8
	$\delta_{N\infty}$	[mm]	0,4	0,5	0,4	1,5	0,9	1,7
<b>HST3 und HST3-R</b>								
Effektive Verankerungstiefe	$h_{ef,1}$	[mm]	1)	40	50	65	1)	1)
Zuglast im gerissenen Beton	N	[kN]	1)	4,3	6,1	9,0	1)	1)
Zugehörige Verschiebung	$\delta_{N0}$	[mm]	1)	0,6	0,4	0,6	1)	1)
	$\delta_{N\infty}$	[mm]	1)	1,3	1,6	1,7	1)	1)
Zuglast im ungerissenen Beton	N	[kN]	1)	6,1	8,5	12,6	1)	1)
Zugehörige Verschiebung	$\delta_{N0}$	[mm]	1)	0,2	0,7	0,8	1)	1)
	$\delta_{N\infty}$	[mm]	1)	0,4	1,2	1,5	1)	1)

1) Leistung nicht bewertet

**Hilti Metallspreizanker HST, HST-R, HST-HCR, HST3, HST3-R**

**Leistungsfähigkeit**  
Verschiebungen unter Zug- und Querbelastung

**Anhang C10**

**Tabelle C6 fortgesetzt**

			M8	M10	M12	M16	M20	M24
<b>Verschiebungen unter Querlast</b>								
<b>HST3</b>								
Effektive Verankerungstiefe	$h_{ef,2}$	[mm]	47	60	70	85	101	125
Querlast im gerissenen und ungerissenen Beton	V	[kN]	7,9	13,5	20,2	31,6	47,9	45,0
Zugehörige Verschiebung	$\delta_{v0}$	[mm]	2,8	2,5	3,8	4,3	2,7	2,0
	$\delta_{v\infty}$	[mm]	4,2	3,7	5,6	6,4	4,1	3,0
Querlast im gerissenen und ungerissenen Beton bei Verwendung des Ankers mit Verfüll-Set	V	[kN]	9,5	14,7	22,3	34,8	57,4	1)
Zugehörige Verschiebung	$\delta_{v0}$	[mm]	2,9	2,3	2,0	2,3	5,9	1)
	$\delta_{v\infty}$	[mm]	4,4	3,4	3,0	3,5	8,8	1)
<b>HST3-R</b>								
Effektive Verankerungstiefe	$h_{ef,2}$	[mm]	47	60	70	85	101	125
Querlast im gerissenen und ungerissenen Beton	V	[kN]	8,9	14,5	21,0	36,3	55,6	57,0
Zugehörige Verschiebung	$\delta_{v0}$	[mm]	7,1	2,3	3,3	5,7	3,2	2,5
	$\delta_{v\infty}$	[mm]	10,7	3,4	4,9	8,5	4,8	3,7
Querlast im gerissenen und ungerissenen Beton bei Verwendung des Ankers mit Verfüll-Set	V	[kN]	11,1	16,2	25,3	40,1	58,7	1)
Zugehörige Verschiebung	$\delta_{v0}$	[mm]	1,9	2,0	2,3	3,4	4,9	1)
	$\delta_{v\infty}$	[mm]	2,9	3,0	3,4	5,0	7,3	1)

1) Leistung nicht bewertet

**Hilti Metallspreizanker HST, HST-R, HST-HCR, HST3, HST3-R**

**Leistungsfähigkeit**  
Verschiebungen unter Zug- und Querbelastung

**Anhang C11**

**Tabelle C6 fortgesetzt**

		M8	M10	M12	M16	M20	M24	
<b>Verschiebungen unter Querlast</b>								
<b>HST3</b>								
Effektive Verankerungstiefe	$h_{ef,1}$ [mm]	1)	40	50	65	1)	1)	
Querlast im gerissenen und ungerissenen Beton	V [kN]	1)	12,5	19,4	31,1	1)	1)	
Zugehörige Verschiebung	$\delta_{v0}$ [mm]	1)	4,2	3,1	4,4	1)	1)	
	$\delta_{v\infty}$ [mm]	1)	6,3	4,7	6,6	1)	1)	
<b>HST3-R</b>								
Effektive Verankerungstiefe	$h_{ef,1}$ [mm]	1)	40	50	65	1)	1)	
Querlast im gerissenen und ungerissenen Beton	V [kN]	1)	14,6	17,8	27,8	1)	1)	
Zugehörige Verschiebung	$\delta_{v0}$ [mm]	1)	3,7	3,9	3,5	1)	1)	
	$\delta_{v\infty}$ [mm]	1)	5,6	5,8	5,3	1)	1)	

1) Leistung nicht bewertet

**Hilti Metallspreizanker HST, HST-R, HST-HCR, HST3, HST3-R**

**Leistungsfähigkeit**  
Verschiebungen unter Zug- und Querbelastung

**Anhang C12**

**Tabelle C7: Charakteristische Werte der Zugtragfähigkeit bei Erdbebenbeanspruchung für Hilti Metallspreizanker HST und HST-R, Leistungskategorie C1**

			M8	M10	M12	M16	M20	M24
<b>Stahlversagen</b>								
<b>HST</b>								
Charakteristische Zugtragfähigkeit	$N_{Rk,s,C1}$	[kN]	3)	32,0	45,0	76,0	3)	3)
Teilsicherheitsbeiwert	$\gamma_{Ms,C1}$	1)	[-]	3)	1,50		3)	3)
<b>HST-R</b>								
Charakteristische Zugtragfähigkeit	$N_{Rk,s,C1}$	[kN]	3)	28,0	40,0	69,0	3)	3)
Teilsicherheitsbeiwert	$\gamma_{Ms,C1}$	1)	[-]	3)	1,50		1,56	3)
<b>Herausziehen</b>								
<b>HST und HST-R</b>								
Charakteristische Zugtragfähigkeit	$N_{Rk,p,C1}$	[kN]	3)	8,0	10,7	18,0	3)	3)
Montagesicherheitsbeiwert	$\gamma_{inst}$	[-]	3)	1,00			3)	3)
<b>Betonausbruch</b> 2)								
<b>HST und HST-R</b>								
Montagesicherheitsbeiwert	$\gamma_{inst}$	[-]	3)	1,00			3)	3)
<b>Spalten</b> 2)								
<b>HST und HST-R</b>								
Montagesicherheitsbeiwert	$\gamma_{inst}$	[-]	3)	1,00			3)	3)

1) Sofern andere nationale Regelungen fehlen

2) Für Betonausbruch und Spalten siehe EN 1992-4:2018

3) Leistung nicht bewertet

**Hilti Metallspreizanker HST, HST-R, HST-HCR, HST3, HST3-R**

**Leistungsfähigkeit**

Charakteristische Werte der Zugtragfähigkeit für Leistungskategorie C1

**Anhang C13**



**Tabelle C8: Charakteristische Werte der Zugtragfähigkeit bei Erdbebenbeanspruchung für Hilti Metallspreizanker HST3 und HST3-R, Leistungskategorie C1**

		M8	M10	M12	M16	M20	M24
<b>Stahlversagen</b>							
<b>HST3</b>							
Effektive Verankerungstiefe	$h_{ef,2}$ [mm]	47	60	70	85	101	3)
Charakteristische Zugtragfähigkeit	$N_{Rk,s,C1}$ [kN]	19,7	32,5	45,1	76,0	124,2	3)
Teilsicherheitsbeiwert	$\gamma_{Ms,C1}^{1)}$ [-]	1,40					3)
<b>HST3-R</b>							
Effektive Verankerungstiefe	$h_{ef,2}$ [mm]	47	60	70	85	101	3)
Charakteristische Zugtragfähigkeit	$N_{Rk,s,C1}$ [kN]	17,7	28,7	42,5	69,4	115,8	3)
Teilsicherheitsbeiwert	$\gamma_{Ms,C1}^{1)}$ [-]	1,40					3)
<b>Herausziehen</b>							
<b>HST3</b>							
Effektive Verankerungstiefe	$h_{ef,2}$ [mm]	47	60	70	85	101	3)
Charakteristische Zugtragfähigkeit	$N_{Rk,p,C1}$ [kN]	8,0	15,0	20,0	27,0	35,0	3)
Montagesicherheitsbeiwert	$\gamma_{inst}$ [-]	1,00					3)
Effektive Verankerungstiefe	$h_{ef,1}$ [mm]	3)	3)	50	3)	3)	3)
Charakteristische Zugtragfähigkeit	$N_{Rk,p,C1}$ [kN]	3)	3)	12,2	3)	3)	3)
Montagesicherheitsbeiwert	$\gamma_{inst}$ [-]	1,00					3)
<b>HST3-R</b>							
Effektive Verankerungstiefe	$h_{ef,2}$ [mm]	47	60	70	85	101	3)
Charakteristische Zugtragfähigkeit	$N_{Rk,p,C1}$ [kN]	8,5	15,0	20,0	27,0	35,0	3)
Montagesicherheitsbeiwert	$\gamma_{inst}$ [-]	1,00					3)

1) Sofern andere nationale Regelungen fehlen

2) Für Betonausbruch und Spalten siehe EN 1992-4:2018

3) Leistung nicht bewertet

**Hilti Metallspreizanker HST, HST-R, HST-HCR, HST3, HST3-R**

**Leistungsfähigkeit**

Charakteristische Werte der Zugtragfähigkeit für Leistungskategorie C1

**Anhang C14**

**Tabelle C8 fortgesetzt**

			M8	M10	M12	M16	M20	M24
<b>Betonausbruch</b> <sup>2)</sup>								
<b>HST3 und HST3-R</b>								
Effektive Verankerungstiefe	$h_{ef,2}$	[mm]	47	60	70	85	101	<sup>3)</sup>
Montagesicherheitsbeiwert	$\gamma_{inst}$	[-]	1,00					<sup>3)</sup>
<b>Spalten</b> <sup>2)</sup>								
<b>HST3 und HST3-R</b>								
Effektive Verankerungstiefe	$h_{ef,2}$	[mm]	47	60	70	85	101	<sup>3)</sup>
Montagesicherheitsbeiwert	$\gamma_{inst}$	[-]	1,00					<sup>3)</sup>

<sup>1)</sup> Sofern andere nationale Regelungen fehlen

<sup>2)</sup> Für Betonausbruch und Spalten siehe EN 1992-4:2018

<sup>3)</sup> Leistung nicht bewertet

**Hilti Metallspreizanker HST, HST-R, HST-HCR, HST3, HST3-R**

**Leistungsfähigkeit**

Charakteristische Werte der Zugtragfähigkeit für Leistungskategorie C1

**Anhang C15**

**Tabelle C9: Charakteristische Werte der Quertragfähigkeit bei Erdbebenbeanspruchung für Hilti Metallspreizanker HST und HST-R, Leistungskategorie C1**

			M8	M10	M12	M16	M20	M24
<b>Stahlversagen</b>								
<b>HST</b>								
Charakteristische Quertragfähigkeit	$V_{Rk,s,C1}$	[kN]	3)	16,0	27,0	41,3	3)	3)
Teilsicherheitsbeiwert	$\gamma_{Ms,C1}$	1)	[-]	3)	1,25		3)	3)
<b>HST-R</b>								
Charakteristische Quertragfähigkeit	$V_{Rk,s,C1}$	[kN]	3)	13,6	23,1	37,5	3)	3)
Teilsicherheitsbeiwert	$\gamma_{Ms,C1}$	1)	[-]	3)	1,25		1,30	3)
<b>Betonausbruch auf der lastabgewandten Seite</b> 2)								
<b>HST und HST-R</b>								
Montagesicherheitsbeiwert	$\gamma_{inst}$	[-]	3)	1,00			3)	3)
<b>Betonkantenbruch</b> 2)								
<b>HST und HST-R</b>								
Montagesicherheitsbeiwert	$\gamma_{inst}$	[-]	3)	1,00			3)	3)

1) Sofern andere nationale Regelungen fehlen

2) Für Betonausbruch auf der lastabgewandten Seite und Betonkantenbruch siehe EN 1992-4:2018

3) Leistung nicht bewertet

**Hilti Metallspreizanker HST, HST-R, HST-HCR, HST3, HST3-R**

**Leistungsfähigkeit**

Charakteristische Werte der Quertragfähigkeit für Leistungskategorie C1

**Anhang C16**

**Tabelle C10: Charakteristische Werte der Quertragfähigkeit bei Erdbebenbeanspruchung für Hilti Metallspreizanker HST3 und HST3-R, Leistungskategorie C1**

		M8	M10	M12	M16	M20	M24
<b>Stahlversagen</b>							
<b>HST3</b>							
Effektive Verankerungstiefe	$h_{ef,2}$ [mm]	47	60	70	85	101	3)
Charakteristische Quertragfähigkeit	$V_{Rk,s,C1}$ [kN]	12,5	21,4	32,2	48,7	77,6	3)
Charakteristische Quertragfähigkeit bei Verwendung des Ankers mit dem Verfüll-Set	$V_{Rk,s,C1}$ [kN]	16,6	25,8	39,0	60,9	100,4	3)
Teilsicherheitsbeiwert	$\gamma_{Ms,C1}^{1)}$ [-]	1,25					3)
Effektive Verankerungstiefe	$h_{ef,1}$ [mm]	3)	3)	50	3)	3)	3)
Charakteristische Quertragfähigkeit	$V_{Rk,s,C1}$ [kN]	3)	3)	32,3	3)	3)	3)
Teilsicherheitsbeiwert	$\gamma_{Ms,C1}^{1)}$ [-]	1,25					3)
<b>HST3-R</b>							
Effektive Verankerungstiefe	$h_{ef,2}$ [mm]	47	60	70	85	101	3)
Charakteristische Quertragfähigkeit	$V_{Rk,s,C1}$ [kN]	15,0	22,8	36,6	60,4	56,7	3)
Charakteristische Quertragfähigkeit bei Verwendung des Ankers mit dem Verfüll-Set	$V_{Rk,s,C1}$ [kN]	19,5	28,4	44,3	70,2	102,7	3)
Teilsicherheitsbeiwert	$\gamma_{Ms,C1}^{1)}$ [-]	1,25					3)
<b>Betonausbruch auf der lastabgewandten Seite <sup>2)</sup></b>							
<b>HST3 und HST3-R</b>							
Effektive Verankerungstiefe	$h_{ef,2}$ [mm]	47	60	70	85	101	3)
Montagesicherheitsbeiwert	$\gamma_{inst}$ [-]	1,00					3)
<b>Betonkantenbruch <sup>2)</sup></b>							
<b>HST3 und HST3-R</b>							
Effektive Verankerungstiefe	$h_{ef,2}$ [mm]	47	60	70	85	101	3)
Montagesicherheitsbeiwert	$\gamma_{inst}$ [-]	1,00					3)

<sup>1)</sup> Sofern andere nationale Regelungen fehlen

<sup>2)</sup> Für Betonausbruch auf der lastabgewandten Seite und Betonkantenbruch siehe EN 1992-4:2018

<sup>3)</sup> Leistung nicht bewertet

**Hilti Metallspreizanker HST, HST-R, HST-HCR, HST3, HST3-R**

**Leistungsfähigkeit**

Charakteristische Werte der Quertragfähigkeit für Leistungskategorie C1

**Anhang C17**

**Tabelle C11: Charakteristische Werte der Zugtragfähigkeit bei Erdbebenbeanspruchung für Hilti Metallspreizanker HST und HST-R, Leistungskategorie C2**

			M8	M10	M12	M16	M20	M24
<b>Stahlversagen</b>								
<b>HST</b>								
Charakteristische Zugtragfähigkeit	$N_{Rk,s,C2}$	[kN]	3)	32,0	45,0	76,0	3)	3)
Teilsicherheitsbeiwert	$\gamma_{Ms,C2}$	1)	[-]	3)	1,50		3)	3)
<b>HST-R</b>								
Charakteristische Zugtragfähigkeit	$N_{Rk,s,C2}$	[kN]	3)	28,0	40,0	69,0	3)	3)
Teilsicherheitsbeiwert	$\gamma_{Ms,C2}$	1)	[-]	3)	1,50		1,56	3)
<b>Herausziehen</b>								
<b>HST und HST-R</b>								
Charakteristische Zugtragfähigkeit	$N_{Rk,p,C2}$	[kN]	3)	3,3	10,0	12,8	3)	3)
Montagesicherheitsbeiwert	$\gamma_{inst}$	[-]	3)	1,00			3)	3)
<b>Betonausbruch</b> 2)								
<b>HST und HST-R</b>								
Montagesicherheitsbeiwert	$\gamma_{inst}$	[-]	3)	1,00			3)	3)
<b>Spalten</b> 2)								
<b>HST und HST-R</b>								
Montagesicherheitsbeiwert	$\gamma_{inst}$	[-]	3)	1,00			3)	3)

1) Sofern andere nationale Regelungen fehlen

2) Für Betonausbruch und Spalten siehe EN 1992-4:2018

3) Leistung nicht bewertet

**Table C12: Verschiebungen unter Zuglast bei Erdbebenbeanspruchung für Hilti Metallspreizanker HST und HST-R, Leistungskategorie C2**

			M8	M10	M12	M16	M20	M24
<b>HST und HST-R</b>								
Verschiebung DLS	$\delta_{N,C2(DLS)}$	[mm]	1)	1,4	6,7	4,0	1)	1)
Verschiebung ULS	$\delta_{N,C2(ULS)}$	[mm]	1)	8,6	15,9	13,3	1)	1)

1) Leistung nicht bewertet

**Hilti Metallspreizanker HST, HST-R, HST-HCR, HST3, HST3-R**

**Leistungsfähigkeit**

Charakteristische Werte der Zugtragfähigkeit und Verschiebungen unter Zuglast für Leistungskategorie C2

**Anhang C18**

**Tabelle C13: Charakteristische Werte der Zugtragfähigkeit bei Erdbebenbeanspruchung für Hilti Metallspreizanker HST3 und HST3-R, Leistungskategorie C2**

			M8	M10	M12	M16	M20	M24
<b>Stahlversagen</b>								
<b>HST3</b>								
Effektive Verankerungstiefe	$h_{ef,2}$	[mm]	47	60	70	85	101	3)
Effektive Verankerungstiefe	$h_{ef,1}$	[mm]	3)	3)	50	3)	3)	3)
Charakteristische Zugtragfähigkeit	$N_{Rk,s,C2}$	[kN]	19,7	32,5	45,1	76,0	124,2	3)
Teilsicherheitsbeiwert	$\gamma_{Ms,C2}^{1)}$	[-]	1,40					3)
<b>HST3-R</b>								
Effektive Verankerungstiefe	$h_{ef,2}$	[mm]	47	60	70	85	101	3)
Charakteristische Zugtragfähigkeit	$N_{Rk,s,C2}$	[kN]	17,7	28,7	42,5	69,4	115,8	3)
Teilsicherheitsbeiwert	$\gamma_{Ms,C2}^{1)}$	[-]	1,40					3)
<b>Herausziehen</b>								
<b>HST3</b>								
Effektive Verankerungstiefe	$h_{ef,2}$	[mm]	47	60	70	85	101	3)
Charakteristische Zugtragfähigkeit	$N_{Rk,p,C2}$	[kN]	3,0	10,4	19,5	27,0	35,0	3)
Montagesicherheitsbeiwert	$\gamma_{inst}$	[-]	1,00					3)
Effektive Verankerungstiefe	$h_{ef,1}$	[mm]	3)	3)	50	3)	3)	3)
Charakteristische Zugtragfähigkeit	$N_{Rk,p,C2}$	[kN]	3)	3)	11,4	3)	3)	3)
Montagesicherheitsbeiwert	$\gamma_{inst}$	[-]	1,00					3)
<b>HST3-R</b>								
Effektive Verankerungstiefe	$h_{ef,2}$	[mm]	47	60	70	85	101	3)
Charakteristische Zugtragfähigkeit	$N_{Rk,p,C2}$	[kN]	3,4	10,4	19,5	27,0	35,0	3)
Montagesicherheitsbeiwert	$\gamma_{inst}$	[-]	1,00					3)
<b>Betonausbruch<sup>2)</sup></b>								
<b>HST3 und HST3-R</b>								
Effektive Verankerungstiefe	$h_{ef,2}$	[mm]	47	60	70	85	101	3)
Effektive Verankerungstiefe	$h_{ef,1}$	[mm]	3)	3)	50	3)	3)	3)
Montagesicherheitsbeiwert	$\gamma_{inst}$	[-]	1,00					3)

1) Sofern andere nationale Regelungen fehlen

2) Für Betonausbruch und Spalten siehe EN 1992-4:2018

3) Leistung nicht bewertet

**Hilti Metallspreizanker HST, HST-R, HST-HCR, HST3, HST3-R**

**Leistungsfähigkeit**

Charakteristische Werte der Zugtragfähigkeit für Leistungskategorie C2

**Anhang C19**

**Tabelle C13 fortgesetzt**

			M8	M10	M12	M16	M20	M24
<b>Spalten</b> <sup>2)</sup>								
<b>HST3 und HST3-R</b>								
Effektive Verankerungstiefe	$h_{ef,2}$	[mm]	47	60	70	85	101	<sup>3)</sup>
Effektive Verankerungstiefe	$h_{ef,1}$	[mm]	<sup>3)</sup>	<sup>3)</sup>	50	<sup>3)</sup>	<sup>3)</sup>	<sup>3)</sup>
Montagesicherheitsbeiwert	$\gamma_{inst}$	[-]	1,00					<sup>3)</sup>

<sup>1)</sup> Sofern andere nationale Regelungen fehlen

<sup>2)</sup> Für Betonausbruch und Spalten siehe EN 1992-4:2018

<sup>3)</sup> Leistung nicht bewertet

**Tabelle C14: Verschiebungen unter Zuglast bei Erdbebenbeanspruchung für Hilti  
Metallspreizanker HST3 und HST3-R, Leistungskategorie C2**

			M8	M10	M12	M16	M20	M24
<b>HST3 und HST3-R</b>								
Effektive Verankerungstiefe	$h_{ef,2}$	[mm]	47	60	70	85	101	<sup>1)</sup>
Verschiebung DLS	$\delta_{N,C2(DLS)}$	[mm]	2,7	3,9	5,2	5,2	6,9	<sup>1)</sup>
Verschiebung ULS	$\delta_{N,C2(ULS)}$	[mm]	10,5	13,7	13,9	11,9	18,4	<sup>1)</sup>
<b>HST3</b>								
Effektive Verankerungstiefe	$h_{ef,1}$	[mm]	<sup>1)</sup>	<sup>1)</sup>	50	<sup>1)</sup>	<sup>1)</sup>	<sup>1)</sup>
Verschiebung DLS	$\delta_{N,C2(DLS)}$	[mm]	<sup>1)</sup>	<sup>1)</sup>	1,2	<sup>1)</sup>	<sup>1)</sup>	<sup>1)</sup>
Verschiebung ULS	$\delta_{N,C2(ULS)}$	[mm]	<sup>1)</sup>	<sup>1)</sup>	2,5	<sup>1)</sup>	<sup>1)</sup>	<sup>1)</sup>

<sup>1)</sup> Leistung nicht bewertet

**Hilti Metallspreizanker HST, HST-R, HST-HCR, HST3, HST3-R**

**Leistungsfähigkeit**

Charakteristische Werte der Zugtragfähigkeit und Verschiebungen unter Zuglast für  
Leistungskategorie C2

**Anhang C20**

**Tabelle C15: Charakteristische Werte der Quertragfähigkeit bei Erdbebenbeanspruchung für Hilti Metallspreizanker HST und HST-R, Leistungskategorie C2**

			M8	M10	M12	M16	M20	M24
<b>Stahlversagen</b>								
<b>HST</b>								
Charakteristische Quertragfähigkeit	$V_{Rk,s,C2}$	[kN]	3)	14,3	21,0	41,3	3)	3)
Teilsicherheitsbeiwert	$\gamma_{Ms,C2}$	1) [-]	3)	1,25			3)	3)
<b>HST-R</b>								
Charakteristische Quertragfähigkeit	$V_{Rk,s,C2}$	[kN]	3)	12,0	18,0	37,5	3)	3)
Teilsicherheitsbeiwert	$\gamma_{Ms,C2}$	1) [-]	3)	1,25		1,30	3)	3)
<b>Betonausbruch auf der lastabgewandten Seite</b> 2)								
<b>HST und HST-R</b>								
Montagesicherheitsbeiwert	$\gamma_{inst}$	[-]	3)	1,00			3)	3)
<b>Betonkantenbruch</b> 2)								
<b>HST und HST-R</b>								
Montagesicherheitsbeiwert	$\gamma_{inst}$	[-]	3)	1,00			3)	3)

1) Sofern andere nationale Regelungen fehlen

2) Für Betonausbruch auf der lastabgewandten Seite und Betonkantenbruch siehe EN 1992-4:2018

3) Leistung nicht bewertet

**Tabelle C16: Verschiebungen unter Querlast bei Erdbebenbeanspruchung für Hilti Metallspreizanker HST und HST-R, Leistungskategorie C2**

			M8	M10	M12	M16	M20	M24
<b>HST und HST-R</b>								
Verschiebung DLS	$\delta_{V,C2(DLS)}$	[mm]	1)	4,2	5,3	5,7	1)	1)
Verschiebung ULS	$\delta_{V,C2(ULS)}$	[mm]	1)	7,5	7,9	8,9	1)	1)

1) Leistung nicht bewertet

**Hilti Metallspreizanker HST, HST-R, HST-HCR, HST3, HST3-R**

**Leistungsfähigkeit**

Charakteristische Werte der Quertragfähigkeit und Verschiebungen unter Querlast für Leistungskategorie C2

**Anhang C21**



**Tabelle C17: Charakteristische Werte der Quertragfähigkeit bei Erdbebenbeanspruchung für Hilti Metallspreizanker HST3 und HST3-R, Leistungskategorie C2**

		M8	M10	M12	M16	M20	M24
<b>Stahlversagen</b>							
<b>HST3</b>							
Effektive Verankerungstiefe	$h_{ef,2}$ [mm]	47	60	70	85	101	3)
Charakteristische Quertragfähigkeit	$V_{Rk,s,C2}$ [kN]	9,5	16,1	26,1	42,4	66,9	3)
Charakteristische Quertragfähigkeit bei Verwendung des Ankers mit dem Verfüll-Set	$V_{Rk,s,C2}$ [kN]	9,9	19,0	28,6	48,5	84,3	3)
Teilsicherheitsbeiwert	$\gamma_{Ms,C2}^{1)}$ [-]	1,25					3)
Effektive Verankerungstiefe	$h_{ef,1}$ [mm]	3)	3)	50	3)	3)	3)
Charakteristische Quertragfähigkeit	$V_{Rk,s,C2}$ [kN]	3)	3)	15,6	3)	3)	3)
Teilsicherheitsbeiwert	$\gamma_{Ms,C2}^{1)}$ [-]	1,25					3)
<b>HST3-R</b>							
Effektive Verankerungstiefe	$h_{ef,2}$ [mm]	47	60	70	85	101	3)
Charakteristische Quertragfähigkeit	$V_{Rk,s,C2}$ [kN]	8,1	15,7	22,4	42,6	49,5	3)
Charakteristische Quertragfähigkeit bei Verwendung des Ankers mit dem Verfüll-Set	$V_{Rk,s,C2}$ [kN]	9,9	17,2	27,6	42,5	67,4	3)
Teilsicherheitsbeiwert	$\gamma_{Ms,C2}^{1)}$ [-]	1,25					3)
<b>Betonausbruch auf der lastabgewandten Seite <sup>2)</sup></b>							
<b>HST3 und HST3-R</b>							
Effektive Verankerungstiefe	$h_{ef,2}$ [mm]	47	60	70	85	101	3)
Effektive Verankerungstiefe	$h_{ef,1}$ [mm]	3)	3)	50	3)	3)	3)
Montagesicherheitsbeiwert	$\gamma_{inst}$ [-]	1,00					3)
<b>Betonkantenbruch <sup>2)</sup></b>							
<b>HST3 und HST3-R</b>							
Effektive Verankerungstiefe	$h_{ef,2}$ [mm]	47	60	70	85	101	3)
Effektive Verankerungstiefe	$h_{ef,1}$ [mm]	3)	3)	50	3)	3)	3)
Montagesicherheitsbeiwert	$\gamma_{inst}$ [-]	1,00					3)

<sup>1)</sup> Sofern andere nationale Regelungen fehlen

<sup>2)</sup> Für Betonausbruch auf der lastabgewandten Seite und Betonkantenbruch siehe EN 1992-4:2018

<sup>3)</sup> Leistung nicht bewertet

**Hilti Metallspreizanker HST, HST-R, HST-HCR, HST3, HST3-R**

**Leistungsfähigkeit**  
Charakteristische Werte der Quertragfähigkeit für Leistungskategorie C2

**Anhang C22**

**Tabelle C18: Verschiebungen unter Querlast bei Erdbebenbeanspruchung für Hilti  
Metallspreizanker HST3 und HST3-R, Leistungskategorie C2**

			M8	M10	M12	M16	M20	M24
<b>HST3</b>								
Effektive Verankerungstiefe	$h_{ef,2}$	[mm]	47	60	70	85	101	1)
Verschiebung DLS	$\delta_{V,C2(DLS)}$	[mm]	3,4	4,0	4,6	4,8	5,2	1)
Verschiebung DLS bei Verwendung des Ankers mit dem Verfüll-Set	$\delta_{V,C2(DLS)}$	[mm]	1,4	1,6	2,5	1,7	1,9	1)
Verschiebung ULS	$\delta_{V,C2(ULS)}$	[mm]	4,9	6,2	8,1	8,2	10,0	1)
Verschiebung ULS bei Verwendung des Ankers mit dem Verfüll-Set	$\delta_{V,C2(ULS)}$	[mm]	4,3	4,4	7,2	3,9	5,3	1)
Effektive Verankerungstiefe	$h_{ef,1}$	[mm]	1)	1)	50	1)	1)	1)
Verschiebung DLS	$\delta_{V,C2(DLS)}$	[mm]	1)	1)	5,2	1)	1)	1)
Verschiebung ULS	$\delta_{V,C2(ULS)}$	[mm]	1)	1)	8,4	1)	1)	1)
<b>HST3-R</b>								
Effektive Verankerungstiefe	$h_{ef,2}$	[mm]	47	60	70	85	101	1)
Verschiebung DLS	$\delta_{V,C2(DLS)}$	[mm]	3,5	5,0	6,0	5,8	3,9	1)
Verschiebung DLS bei Verwendung des Ankers mit dem Verfüll-Set	$\delta_{V,C2(DLS)}$	[mm]	1,6	1,6	2,0	1,9	2,2	1)
Verschiebung ULS	$\delta_{V,C2(ULS)}$	[mm]	7,5	9,1	10,1	12,3	7,0	1)
Verschiebung ULS bei Verwendung des Ankers mit dem Verfüll-Set	$\delta_{V,C2(ULS)}$	[mm]	5,0	7,6	6,8	4,7	5,8	1)

1) Leistung nicht bewertet

**Hilti Metallspreizanker HST, HST-R, HST-HCR, HST3, HST3-R**

**Leistungsfähigkeit**  
Verschiebungen unter Querlast für Leistungskategorie C2

**Anhang C23**

**Tabelle C19: Charakteristische Zugtragfähigkeit bei Brandbeanspruchung für Hilti Metallspreizanker HST, HST-R und HST-HCR im gerissenen und ungerissenen Beton**

				M8	M10	M12	M16	M20 <sup>1)</sup>	M24 <sup>1)</sup>
<b>Stahlversagen</b>									
<b>HST</b>									
Charakteristische Zugtragfähigkeit	R30	$N_{Rk,s,fi}$	[kN]	0,9	2,5	5,0	9,0	15,0	20,0
	R60	$N_{Rk,s,fi}$	[kN]	0,7	1,5	3,5	6,0	10,0	15,0
	R90	$N_{Rk,s,fi}$	[kN]	0,6	1,0	2,0	3,5	6,0	8,0
	R120	$N_{Rk,s,fi}$	[kN]	0,5	0,7	1,0	2,0	3,5	5,0
<b>HST-R und HST HCR</b>									
Charakteristische Zugtragfähigkeit	R30	$N_{Rk,s,fi}$	[kN]	4,9	11,8	17,2	32,0	49,9	71,9
	R60	$N_{Rk,s,fi}$	[kN]	3,6	8,4	12,2	22,8	35,5	51,2
	R90	$N_{Rk,s,fi}$	[kN]	2,4	5,0	7,3	13,5	21,1	30,4
	R120	$N_{Rk,s,fi}$	[kN]	1,7	3,3	4,8	8,9	13,9	20,0
<b>Herausziehen</b>									
<b>HST</b>									
Charakteristische Zugtragfähigkeit in Beton $\geq$ C20/25	R30	$N_{Rk,p,fi}$	[kN]	1,3	2,3	3,0	5,0	7,5	10,0
	R60	$N_{Rk,p,fi}$	[kN]						
	R90	$N_{Rk,p,fi}$	[kN]						
	R120	$N_{Rk,p,fi}$	[kN]	1,0	1,8	2,4	4,0	6,0	8,0
<b>HST-R und HST-HCR</b>									
Charakteristische Zugtragfähigkeit in Beton $\geq$ C20/25	R30	$N_{Rk,p,fi}$	[kN]	1,3	2,3	3,0	6,3	7,5	10,0
	R60	$N_{Rk,p,fi}$	[kN]						
	R90	$N_{Rk,p,fi}$	[kN]						
	R120	$N_{Rk,p,fi}$	[kN]	1,0	1,8	2,4	5,0	6,0	8,0

<sup>1)</sup> Nur HST und HST-R

Sofern andere nationale Regelungen fehlen wird der Teilsicherheitsbeiwert für die Brandbeanspruchung  $\gamma_{M,fi} = 1,0$  empfohlen.

**Hilti Metallspreizanker HST, HST-R, HST-HCR, HST3, HST3-R**

**Leistungsfähigkeit**

Charakteristische Werte der Zugtragfähigkeit bei Brandbeanspruchung im gerissenen und ungerissenen Beton

**Anhang C24**

**Tabelle C19 fortgesetzt**

				M8	M10	M12	M16	M20 <sup>1)</sup>	M24 <sup>1)</sup>
<b>Betonausbruch</b>									
<b>HST, HST-R und HST-HCR</b>									
Charakteristische Zugtragfähigkeit in Beton $\geq$ C20/25	R30	$N^0_{Rk,c,fi}$	[kN]	2,7	5,0	7,4	11,0	18,5	31,4
	R60	$N^0_{Rk,c,fi}$	[kN]						
	R90	$N^0_{Rk,c,fi}$	[kN]						
	R120	$N^0_{Rk,c,fi}$	[kN]						
Achsabstand	Scr,N	[mm]	4 h <sub>ef</sub>						
	s <sub>min</sub>	[mm]	40	55	60	70	100	125	
Randabstand	C <sub>cr,N</sub>	[mm]	2 h <sub>ef</sub>						
	C <sub>min</sub>	[mm]	Einseitige Brandbeanspruchung: 2 h <sub>ef</sub> Mehrseitige Brandbeanspruchung: $\geq$ 300						

<sup>1)</sup> Nur HST und HST-R

Sofern andere nationale Regelungen fehlen wird der Teilsicherheitsbeiwert für die Brandbeanspruchung  $\gamma_{M,fi} = 1,0$  empfohlen.

**Hilti Metallspreizanker HST, HST-R, HST-HCR, HST3, HST3-R**

**Leistungsfähigkeit**

Charakteristische Werte der Zugtragfähigkeit bei Brandbeanspruchung im gerissenen und ungerissenen Beton

**Anhang C25**

**Tabelle C20: Charakteristische Zugtragfähigkeit bei Brandbeanspruchung für Hilti  
Metallspreizanker HST3 und HST3-R im gerissenen und ungerissenen  
Beton**

			M8	M10	M12	M16	M20	M24
<b>Stahlversagen</b>								
<b>HST3</b>								
Effektive Verankerungstiefe	$h_{ef,2}$	[mm]	47	60	70	85	101	125
Charakteristische Zugtragfähigkeit	R30	$N_{Rk,s,fi}$ [kN]	0,9	2,4	5,2	9,7	15,2	21,9
	R60	$N_{Rk,s,fi}$ [kN]	0,8	1,8	3,7	6,8	10,6	15,3
	R90	$N_{Rk,s,fi}$ [kN]	0,7	1,2	2,1	3,9	6,0	8,7
	R120	$N_{Rk,s,fi}$ [kN]	0,6	0,9	1,3	2,4	3,8	5,4
<b>HST3-R</b>								
Effektive Verankerungstiefe	$h_{ef,2}$	[mm]	47	60	70	85	101	125
Charakteristische Zugtragfähigkeit	R30	$N_{Rk,s,fi}$ [kN]	4,9	11,8	17,1	31,9	49,8	71,8
	R60	$N_{Rk,s,fi}$ [kN]	3,6	8,4	12,2	22,8	35,5	51,2
	R90	$N_{Rk,s,fi}$ [kN]	2,4	5,0	7,3	13,6	21,2	30,6
	R120	$N_{Rk,s,fi}$ [kN]	1,7	3,3	4,8	9,0	14,1	20,3
<b>HST3</b>								
Effektive Verankerungstiefe	$h_{ef,1}$	[mm]	1) <sup>1)</sup>	40	50	65	1) <sup>1)</sup>	1) <sup>1)</sup>
Charakteristische Zugtragfähigkeit	R30	$N_{Rk,s,fi}$ [kN]	1) <sup>1)</sup>	1,5	2,3	4,4	1) <sup>1)</sup>	1) <sup>1)</sup>
	R60	$N_{Rk,s,fi}$ [kN]	1) <sup>1)</sup>	1,2	1,7	3,2	1) <sup>1)</sup>	1) <sup>1)</sup>
	R90	$N_{Rk,s,fi}$ [kN]	1) <sup>1)</sup>	0,9	1,1	2,1	1) <sup>1)</sup>	1) <sup>1)</sup>
	R120	$N_{Rk,s,fi}$ [kN]	1) <sup>1)</sup>	0,8	0,8	1,5	1) <sup>1)</sup>	1) <sup>1)</sup>
<b>HST3-R</b>								
Effektive Verankerungstiefe	$h_{ef,1}$	[mm]	1) <sup>1)</sup>	40	50	65	1) <sup>1)</sup>	1) <sup>1)</sup>
Charakteristische Zugtragfähigkeit	R30	$N_{Rk,s,fi}$ [kN]	1) <sup>1)</sup>	5,2	9,1	16,9	1) <sup>1)</sup>	1) <sup>1)</sup>
	R60	$N_{Rk,s,fi}$ [kN]	1) <sup>1)</sup>	3,7	6,8	12,6	1) <sup>1)</sup>	1) <sup>1)</sup>
	R90	$N_{Rk,s,fi}$ [kN]	1) <sup>1)</sup>	2,5	4,5	8,4	1) <sup>1)</sup>	1) <sup>1)</sup>
	R120	$N_{Rk,s,fi}$ [kN]	1) <sup>1)</sup>	2,0	3,3	6,2	1) <sup>1)</sup>	1) <sup>1)</sup>

<sup>1)</sup> Leistung nicht bewertet

Sofern andere nationale Regelungen fehlen wird der Teilsicherheitsbeiwert für die Brandbeanspruchung  $\gamma_{M,fi} = 1,0$  empfohlen.

**Hilti Metallspreizanker HST, HST-R, HST-HCR, HST3, HST3-R**

**Leistungsfähigkeit**

Charakteristische Werte der Zugtragfähigkeit bei Brandbeanspruchung im gerissenen und ungerissenen Beton

**Anhang C26**

**Tabelle C20 fortgesetzt**

			M8	M10	M12	M16	M20	M24
<b>Herausziehen</b>								
<b>HST3 und HST3-R</b>								
Effektive Verankerungstiefe	$h_{ef,2}$	[mm]	47	60	70	85	101	125
Charakteristische Zugtragfähigkeit in Beton $\geq$ C20/25	R30	$N_{Rk,p,fi}$ [kN]	1,9	3,0	5,0	7,1	9,1	12,6
	R60	$N_{Rk,p,fi}$ [kN]						
	R90	$N_{Rk,p,fi}$ [kN]						
	R120	$N_{Rk,p,fi}$ [kN]						
<b>HST3 und HST3-R</b>								
Effektive Verankerungstiefe	$h_{ef,1}$	[mm]	1)	40	50	65	1)	1)
Charakteristische Zugtragfähigkeit in Beton $\geq$ C20/25	R30	$N_{Rk,p,fi}$ [kN]	1)	2,3	3,2	4,7	1)	1)
	R60	$N_{Rk,p,fi}$ [kN]						
	R90	$N_{Rk,p,fi}$ [kN]						
	R120	$N_{Rk,p,fi}$ [kN]						

1) Leistung nicht bewertet

Sofern andere nationale Regelungen fehlen wird der Teilsicherheitsbeiwert für die Brandbeanspruchung  $\gamma_{M,fi} = 1,0$  empfohlen.

**Hilti Metallspreizanker HST, HST-R, HST-HCR, HST3, HST3-R**

**Leistungsfähigkeit**

Charakteristische Werte der Zugtragfähigkeit bei Brandbeanspruchung im gerissenen und ungerissenen Beton

**Anhang C27**

**Tabelle C20 fortgesetzt**

			M8	M10	M12	M16	M20	M24
<b>Betonausbruch</b>								
<b>HST3 und HST3-R</b>								
Effektive Verankerungstiefe	$h_{ef,2}$	[mm]	47	60	70	85	101	125
Charakteristische Zugtragfähigkeit in Beton $\geq$ C20/25	R30	$N^0_{RK,c,fi}$ [kN]	2,7	5,0	7,4	12,0	18,5	31,4
	R60	$N^0_{RK,c,fi}$ [kN]						
	R90	$N^0_{RK,c,fi}$ [kN]						
	R120	$N^0_{RK,c,fi}$ [kN]						
Achsabstand	$s_{cr,N}$	[mm]	4 $h_{ef}$					
	$s_{min}$	[mm]	35	40	50	65	90	125
Randabstand	$c_{cr,N}$	[mm]	2 $h_{ef}$					
	$c_{min}$	[mm]	Einseitige Brandbeanspruchung: 2 $h_{ef}$ Mehrseitige Brandbeanspruchung: $\geq$ 300					
<b>HST3 und HST3-R</b>								
Effektive Verankerungstiefe	$h_{ef,1}$	[mm]	1)	40	50	65	1)	1)
Charakteristische Zugtragfähigkeit in Beton $\geq$ C20/25	R30	$N^0_{RK,c,fi}$ [kN]	1)	1,8	3,2	6,1	1)	1)
	R60	$N^0_{RK,c,fi}$ [kN]						
	R90	$N^0_{RK,c,fi}$ [kN]						
	R120	$N^0_{RK,c,fi}$ [kN]						
Achsabstand	$s_{cr,N}$	[mm]	1)	4 $h_{ef}$			1)	1)
	$s_{min}$	[mm]	1)	40	50	65	1)	1)
Randabstand	$c_{cr,N}$	[mm]	1)	2 $h_{ef}$			1)	1)
	$c_{min}$	[mm]	Einseitige Brandbeanspruchung: 2 $h_{ef}$ Mehrseitige Brandbeanspruchung: $\geq$ 300					

1) Leistung nicht bewertet

Sofern andere nationale Regelungen fehlen wird der Teilsicherheitsbeiwert für die Brandbeanspruchung  $\gamma_{M,fi} = 1,0$  empfohlen.

**Hilti Metallspreizanker HST, HST-R, HST-HCR, HST3, HST3-R**

**Leistungsfähigkeit**

Charakteristische Werte der Zugtragfähigkeit bei Brandbeanspruchung im gerissenen und ungerissenen Beton

**Anhang C28**

**Tabelle C21: Charakteristische Quertragfähigkeit bei Brandbeanspruchung für Hilti Metallspreizanker HST, HST-R und HST-HCR im gerissenen und ungerissenen Beton**

				M8	M10	M12	M16	M20 <sup>1)</sup>	M24 <sup>1)</sup>
<b>Stahlversagen ohne Hebelarm</b>									
<b>HST</b>									
Charakteristische Quertragfähigkeit	R30	$V_{Rk,s,fi}$	[kN]	0,9	2,5	5,0	9,0	15,0	20,0
	R60	$V_{Rk,s,fi}$	[kN]	0,7	1,5	3,5	6,0	10,0	15,0
	R90	$V_{Rk,s,fi}$	[kN]	0,6	1,0	2,0	3,5	6,0	8,0
	R120	$V_{Rk,s,fi}$	[kN]	0,5	0,7	1,0	2,0	3,5	5,0
<b>HST-R und HST HCR</b>									
Charakteristische Quertragfähigkeit	R30	$V_{Rk,s,fi}$	[kN]	4,9	11,8	17,2	32,0	49,9	71,9
	R60	$V_{Rk,s,fi}$	[kN]	3,6	8,4	12,2	22,8	35,5	51,2
	R90	$V_{Rk,s,fi}$	[kN]	2,4	5,0	7,3	13,5	21,1	30,4
	R120	$V_{Rk,s,fi}$	[kN]	1,7	3,3	4,8	8,9	13,9	20,0
<b>Stahlversagen mit Hebelarm</b>									
<b>HST</b>									
Charakteristisches Biegemoment	R30	$M^0_{Rk,s,fi}$	[Nm]	1,0	3,3	8,1	20,6	40,2	69,5
	R60	$M^0_{Rk,s,fi}$	[Nm]	0,8	2,4	5,7	14,4	28,1	48,6
	R90	$M^0_{Rk,s,fi}$	[Nm]	0,7	1,6	3,2	8,2	16,0	27,7
	R120	$M^0_{Rk,s,fi}$	[Nm]	0,6	1,2	2,0	5,1	9,9	17,2
<b>HST-R und HST HCR</b>									
Charakteristisches Biegemoment	R30	$M^0_{Rk,s,fi}$	[Nm]	5,0	15,2	26,6	67,7	132,3	228,6
	R60	$M^0_{Rk,s,fi}$	[Nm]	3,7	10,8	19,0	48,2	94,1	162,6
	R90	$M^0_{Rk,s,fi}$	[Nm]	2,4	6,4	11,3	28,6	55,9	96,6
	R120	$M^0_{Rk,s,fi}$	[Nm]	1,8	4,2	7,4	18,9	36,8	63,7

<sup>1)</sup> Nur HST und HST-R

<sup>2)</sup> Leistung nicht bewertet

Sofern andere nationale Regelungen fehlen wird der Teilsicherheitsbeiwert für die Brandbeanspruchung  $\gamma_{M,fi} = 1,0$  empfohlen.

**Hilti Metallspreizanker HST, HST-R, HST-HCR, HST3, HST3-R**

**Leistungsfähigkeit**

Charakteristische Werte der Quertragfähigkeit bei Brandbeanspruchung im gerissenen und ungerissenen Beton

**Anhang C29**



**Tabelle C21 fortgesetzt**

			M8	M10	M12	M16	M20 <sup>1)</sup>	M24 <sup>1)</sup>
<b>Betonausbruch auf der lastabgewandten Seite</b>								
<b>HST, HST-R und HST-HCR</b>								
Pryout-Faktor	$k_8$	[-]	2,00	2,00	2,20	2,50	2,50	2,50
Charakteristische Quertragfähigkeit in Beton $\geq$ C20/25	R30	$V^0_{Rk,cp,fi}$ [kN]	5,4	10,0	16,0	27,2	49,4	84,5
	R60	$V^0_{Rk,cp,fi}$ [kN]						
	R90	$V^0_{Rk,cp,fi}$ [kN]						
	R120	$V^0_{Rk,cp,fi}$ [kN]						
<b>Betonkantenbruch</b>								
<b>HST, HST-R und HST-HCR</b>								
Der Ausgangswert der charakteristischen Tragfähigkeit $V^0_{Rk,c,fi}$ im Beton C20/25 bis C50/60 unter Brandbeanspruchung wird ermittelt mit: $V^0_{Rk,c,fi} = 0,25 \times V^0_{Rk,c}$ ( $\leq$ R90) $V^0_{Rk,c,fi} = 0,20 \times V^0_{Rk,c}$ (R120) $V^0_{Rk,c}$ = Wert der charakteristischen Tragfähigkeit im gerissenen Beton C20/25 bei Normaltemperatur								

1) Nur HST und HST-R

2) Leistung nicht bewertet

Sofern andere nationale Regelungen fehlen wird der Teilsicherheitsbeiwert für die Brandbeanspruchung  $\gamma_{M,fi} = 1,0$  empfohlen.

**Hilti Metallspreizanker HST, HST-R, HST-HCR, HST3, HST3-R**

**Leistungsfähigkeit**

Charakteristische Werte der Quertragfähigkeit bei Brandbeanspruchung im gerissenen und ungerissenen Beton

**Anhang C30**

**Tabelle C22: Charakteristische Quertragfähigkeit bei Brandbeanspruchung für Hilti  
Metallspreizanker HST3 und HST3-R im gerissenen und ungerissenen  
Beton**

			M8	M10	M12	M16	M20	M24
<b>Stahlversagen ohne Hebelarm</b>								
<b>HST3</b>								
Effektive Verankerungstiefe	$h_{ef,2}$	[mm]	47	60	70	85	101	125
Charakteristische Quertragfähigkeit	R30	$V_{Rk,s,fi}$ [kN]	0,9	2,4	5,2	9,7	15,2	21,9
	R60	$V_{Rk,s,fi}$ [kN]	0,8	1,8	3,7	6,8	10,6	15,3
	R90	$V_{Rk,s,fi}$ [kN]	0,7	1,2	2,1	3,9	6,0	8,7
	R120	$V_{Rk,s,fi}$ [kN]	0,6	0,9	1,3	2,4	3,8	5,4
<b>HST3-R</b>								
Effektive Verankerungstiefe	$h_{ef,2}$	[mm]	47	60	70	85	101	125
Charakteristische Quertragfähigkeit	R30	$V_{Rk,s,fi}$ [kN]	4,9	11,8	17,1	31,9	49,8	71,8
	R60	$V_{Rk,s,fi}$ [kN]	3,6	8,4	12,2	22,8	35,5	51,2
	R90	$V_{Rk,s,fi}$ [kN]	2,4	5,0	7,3	13,6	21,2	30,6
	R120	$V_{Rk,s,fi}$ [kN]	1,7	3,3	4,8	9,0	14,1	20,3
<b>HST3</b>								
Effektive Verankerungstiefe	$h_{ef,1}$	[mm]	1)	40	50	65	1)	1)
Charakteristische Quertragfähigkeit	R30	$V_{Rk,s,fi}$ [kN]	1)	1,5	2,3	4,4	1)	1)
	R60	$V_{Rk,s,fi}$ [kN]	1)	1,2	1,7	3,2	1)	1)
	R90	$V_{Rk,s,fi}$ [kN]	1)	0,9	1,1	2,1	1)	1)
	R120	$V_{Rk,s,fi}$ [kN]	1)	0,8	0,8	1,5	1)	1)
<b>HST3-R</b>								
Effektive Verankerungstiefe	$h_{ef,1}$	[mm]	1)	40	50	65	1)	1)
Charakteristische Quertragfähigkeit	R30	$V_{Rk,s,fi}$ [kN]	1)	5,2	9,1	16,9	1)	1)
	R60	$V_{Rk,s,fi}$ [kN]	1)	3,7	6,8	12,6	1)	1)
	R90	$V_{Rk,s,fi}$ [kN]	1)	2,5	4,5	8,4	1)	1)
	R120	$V_{Rk,s,fi}$ [kN]	1)	2,0	3,3	6,2	1)	1)

1) Leistung nicht bewertet

Sofern andere nationale Regelungen fehlen wird der Teilsicherheitsbeiwert für die Brandbeanspruchung  $\gamma_{M,fi} = 1,0$  empfohlen.

**Hilti Metallspreizanker HST, HST-R, HST-HCR, HST3, HST3-R**

**Leistungsfähigkeit**

Charakteristische Werte der Quertragfähigkeit bei Brandbeanspruchung im gerissenen und ungerissenen Beton

**Anhang C31**

**Tabelle C22 fortgesetzt**

			M8	M10	M12	M16	M20	M24
<b>Stahlversagen mit Hebelarm</b>								
<b>HST3</b>								
Effektive Verankerungstiefe	$h_{ef,2}$	[mm]	47	60	70	85	101	125
Charakteristisches Biegemoment	R30	$M^0_{Rk,s,fi}$ [Nm]	0,9	3,1	8,1	20,6	40,2	69,5
	R60	$M^0_{Rk,s,fi}$ [Nm]	0,8	2,4	5,7	14,4	28,1	48,6
	R90	$M^0_{Rk,s,fi}$ [Nm]	0,7	1,6	3,2	8,2	16,0	27,7
	R120	$M^0_{Rk,s,fi}$ [Nm]	0,6	1,2	2,0	5,1	10,0	17,2
<b>HST3-R</b>								
Effektive Verankerungstiefe	$h_{ef,2}$	[mm]	47	60	70	85	101	125
Charakteristisches Biegemoment	R30	$M^0_{Rk,s,fi}$ [Nm]	5,0	15,2	26,6	67,6	132,0	228,2
	R60	$M^0_{Rk,s,fi}$ [Nm]	3,7	10,8	19,0	48,2	94,1	162,7
	R90	$M^0_{Rk,s,fi}$ [Nm]	2,4	6,5	11,3	28,8	56,3	97,2
	R120	$M^0_{Rk,s,fi}$ [Nm]	1,8	4,3	7,5	19,1	37,3	64,5
<b>HST3</b>								
Effektive Verankerungstiefe	$h_{ef,1}$	[mm]	1)	40	50	65	1)	1)
Charakteristisches Biegemoment	R30	$M^0_{Rk,s,fi}$ [Nm]	1)	2,0	3,6	9,3	1)	1)
	R60	$M^0_{Rk,s,fi}$ [Nm]	1)	1,6	2,7	6,9	1)	1)
	R90	$M^0_{Rk,s,fi}$ [Nm]	1)	1,2	1,8	4,5	1)	1)
	R120	$M^0_{Rk,s,fi}$ [Nm]	1)	1,0	1,3	3,3	1)	1)
<b>HST3-R</b>								
Effektive Verankerungstiefe	$h_{ef,1}$	[mm]	1)	40	50	65	1)	1)
Charakteristisches Biegemoment	R30	$M^0_{Rk,s,fi}$ [Nm]	1)	6,7	14,1	35,9	1)	1)
	R60	$M^0_{Rk,s,fi}$ [Nm]	1)	4,8	10,5	26,8	1)	1)
	R90	$M^0_{Rk,s,fi}$ [Nm]	1)	3,2	7,0	17,7	1)	1)
	R120	$M^0_{Rk,s,fi}$ [Nm]	1)	2,6	5,2	13,2	1)	1)

1) Leistung nicht bewertet

Sofern andere nationale Regelungen fehlen wird der Teilsicherheitsbeiwert für die Brandbeanspruchung  $\gamma_{M,fi} = 1,0$  empfohlen.

**Hilti Metallspreizanker HST, HST-R, HST-HCR, HST3, HST3-R**

**Leistungsfähigkeit**

Charakteristische Werte der Quertragfähigkeit bei Brandbeanspruchung im gerissenen und ungerissenen Beton

**Anhang C32**

**Tabelle C22 fortgesetzt**

			M8	M10	M12	M16	M20	M24
<b>Betonausbruch auf der lastabgewandten Seite</b>								
<b>HST3 und HST3-R</b>								
Effektive Verankerungstiefe	$h_{ef,2}$	[mm]	47	60	70	85	101	125
Pryout-Faktor	$k_8$	[-]	2,62	2,67	2,78	3,41	3,20	2,50
Charakteristische Quertragfähigkeit in Beton $\geq$ C20/25	R30	$V^0_{Rk,cp,fi}$ [kN]	7,0	13,0	20,7	40,8	37,0	62,8
	R60	$V^0_{Rk,cp,fi}$ [kN]						
	R90	$V^0_{Rk,cp,fi}$ [kN]						
	R120	$V^0_{Rk,cp,fi}$ [kN]						
<b>HST3 und HST3-R</b>								
Effektive Verankerungstiefe	$h_{ef,1}$	[mm]	1)	40	50	65	1)	1)
Pryout-Faktor	$k_8$	[-]	1)	2,67	2,78	3,41	1)	1)
Charakteristische Quertragfähigkeit in Beton $\geq$ C20/25	R30	$V^0_{Rk,cp,fi}$ [kN]	1)	4,7	8,9	20,8	1)	1)
	R60	$V^0_{Rk,cp,fi}$ [kN]						
	R90	$V^0_{Rk,cp,fi}$ [kN]						
	R120	$V^0_{Rk,cp,fi}$ [kN]						
<b>Betonkantenbruch</b>								
<b>HST3 und HST3-R</b>								
Der Ausgangswert der charakteristischen Tragfähigkeit $V^0_{Rk,c,fi}$ im Beton C20/25 bis C50/60 unter Brandbeanspruchung wird ermittelt mit: $V^0_{Rk,c,fi} = 0,25 \times V^0_{Rk,c}$ ( $\leq$ R90) $V^0_{Rk,c,fi} = 0,20 \times V^0_{Rk,c}$ (R120) $V^0_{Rk,c}$ = Wert der charakteristischen Tragfähigkeit im gerissenen Beton C20/25 bei Normaltemperatur								

1) Leistung nicht bewertet

Sofern andere nationale Regelungen fehlen wird der Teilsicherheitsbeiwert für die Brandbeanspruchung  $\gamma_{M,fi} = 1,0$  empfohlen.

**Hilti Metallspreizanker HST, HST-R, HST-HCR, HST3, HST3-R**

**Leistungsfähigkeit**

Charakteristische Werte der Quertragfähigkeit bei Brandbeanspruchung im gerissenen und ungerissenen Beton

**Anhang C33**



TLUMACZ PRZYSIĘGLY JĘZYKA ANGIELSKIEGO

mgr Agnieszka Modrzejewska-Fryżewska

ul. Żmudzka 12a/6

85-028 Bydgoszcz tel. 510 199 883

tłumaczenie z języka angielskiego

tekst drukowany (63 strony)

-----początek dokumentu-----



Deutsches Institut für Bautechnik  
Niemiecki Instytut Techniki Budowlanej

Jednostka aprobująca wyroby budowlane  
i typy konstrukcji  
Ośrodek Badawczy Techniki Budowlanej

Instytucja utworzona przez Rząd Federalny  
i Rządy Krajów Związkowych

Upoważniona  
zgodnie z Artykułem 29  
Rozporządzenia  
(Unii Europejskiej)  
Nr 305/2011 oraz członek  
EOTA (Europejskiej  
Organizacji ds. Ocen  
Technicznych

Członek EOTA  
www.eota.eu

## Europejska Ocena Techniczna

**ETA-98/0001**  
**z 13 lipca 2020r.**

Tłumaczenie angielskie przygotowane przez Deutsches Institut für Bautechnik – Wersja oryginalna w języku niemieckim  
Tłumaczenie z języka angielskiego na język polski przygotowane na zlecenie Hilti (Poland) Sp. z o.o.

### Część ogólna

Jednostka Oceny Technicznej wydająca  
niniejszą Europejską Ocena Techniczną

Nazwa handlowa wyrobu budowlanego

Rodzina produktów, do których należy wyrób  
budowlany

Producent

Zakład produkcyjny

Niniejsza Europejska Ocena Techniczna  
zawiera

Niniejsza Europejska Ocena Techniczna  
została wydana zgodnie  
z Rozporządzeniem (Unii Europejskiej)  
Nr 305/2011, na podstawie

Niniejsza wersja zastępuje

Deutsches Institut für Bautechnik

Metalowa kotwa rozporowa Hilti HST, HST-R,  
HST-HCR, HST3, HST3-R

Mechaniczne łączniki do stosowania w betonie

Hilti Spółka Akcyjna  
Dział Zakotwień  
9494 Schaan  
KSIĘSTWO LIECHTENSTEIN

Zakład produkcyjny Hilti

63 strony, w tym 3 Załączniki, które tworzą  
integralną część niniejszej oceny.

EAD 330232-01-0601 Wydanie 12/2019

ETA-98/0001 wydaną 2 października 2019r.

Deutsches Institut für Bautechnik

Kolonnenstraße 30B | 10829 Berlin | NIEMCY | Telefon: +49 30 78730-0 | Faks: +49 30 78730-320 | E-mail: [dibt@dibt.de](mailto:dibt@dibt.de) | [www.dibt.de](http://www.dibt.de)

Z26327.20

8.06.01-93/20



**ETA-98/0001**

Tłumaczenie angielskie przygotowane przez Deutsches Institut für Bautechnik  
Tłumaczenie z j.angielskiego na j.polski wykonane na zlecenie Hilti (Poland) Sp. z o.o.

Niniejsza Europejska Ocena Techniczna została wydana przez Jednostkę Oceny Technicznej w jej języku oficjalnym. Tłumaczenie niniejszej Europejskiej Oceny Technicznej na inne języki musi w pełni odpowiadać oryginalnie wydanemu dokumentowi i powinno być wyraźnie oznaczone jako takowe.

Udostępnianie niniejszej Europejskiej Oceny Technicznej, włącznie z jej przesyłaniem za pomocą metod elektronicznych, jest dopuszczalne jedynie w całości. Kopiowanie części dokumentu może mieć miejsce, jednakże jedynie za pisemną zgodą wydającej go Jednostki Oceny Technicznej. Każde częściowe kopiowanie musi być wyraźnie oznaczone jako takowe.

Niniejsza Europejska Ocena Techniczna może zostać uchylona przez wydającą ją Jednostkę Oceny Technicznej, w szczególności na podstawie informacji Komisji zgodnie z treścią Artykułu 25 Paragraf 3 Rozporządzenia (Unii Europejskiej) Nr 305/2011.





## Część szczegółowa dokumentu

### 1. Opis techniczny produktu

Metalowa kotwa rozporowa Hilti HST, HST-R, HST-HCR, HST3 oraz HST3-R jest kotwą wykonaną ze stali ocynkowanej galwanicznie (HST, HST3), ze stali nierdzewnej (HST-R, HST3-R) lub ze stali o wysokiej odporności na korozję (HST-HCR), którą umieszcza się w wywierconym otworze i osadza z zastosowaniem rozporu kontrolowanego momentem dokręcającym.

Opis produktu został przedstawiony w Załączniku A.

### 2. Wyszczególnienie zamierzonego stosowania wyrobu zgodnie ze stosownym Europejskim Dokumentem Oceny

Właściwości użytkowe podane w Rozdziale 3 obowiązują wyłącznie wtedy, gdy kotwa jest stosowana zgodnie ze specyfikacjami i warunkami podanymi w Załączniku B.

Sprawdzenia i metody oceny, na których opiera się niniejsza Europejska Ocena Techniczna uwzględniają założenie, że okres użytkowania kotwy będzie wynosił 50 lat. Wskazania dotyczące okresu użytkowania nie mogą być interpretowane jako gwarancja udzielona przez producenta, a jedynie jako przesłanki mające pomóc w wyborze odpowiedniego produktu spełniającego oczekiwania z punktu widzenia ekonomicznie optymalnego czasu eksploatacji wykonanych robót.

### 3. Właściwości użytkowe produktu oraz informacje na temat metod użytych do ich oceny

#### 3.1 Wytrzymałość mechaniczna i stateczność (Podstawowe wymaganie 1)

Podstawowa charakterystyka	Właściwości
Nośność charakterystyczna na obciążenia rozciągające (obciążenia statyczne i quasi-statyczne) Metoda A	Patrz → Załączniki od B8 do B13, od C1 do C4
Nośność charakterystyczna na obciążenia ścinające (obciążenia statyczne i quasi-statyczne) Metoda A	Patrz → Załączniki od C5 do C8
Przemieszczenia oraz trwałość	Patrz → Załącznik B1, od C9 do C12
Nośność charakterystyczna oraz przemieszczenia dla kategorii właściwości sejsmicznych C1 oraz C2, przemiesz	Patrz → Załącznik od C13 do C23

#### 3.2 Bezpieczeństwo pożarowe (Podstawowe wymaganie 2)

Podstawowa charakterystyka	Właściwości
Reakcja na działanie ognia	Klasa A1
Odporność ogniowa	Patrz → Załączniki od C24 do C33



**4 Zastosowany system oceny i weryfikacji stałości właściwości użytkowych (AVCP) oraz informacje nt. podstawy prawnej**

Zgodnie z Europejskim Dokumentem Oceny EAD 330232-01-0601 zastosowanie ma europejski akt prawny: [96/582/EC].

Zastosowanie ma system: 1.

**5 Szczegóły techniczne konieczne do wdrożenia systemu oceny i weryfikacji stałości właściwości użytkowych (AVCP) uwzględnione w odpowiednim Europejskim Dokumencie Oceny**

Szczegóły techniczne konieczne do wdrożenia systemu oceny i weryfikacji stałości właściwości użytkowych (AVCP) są zawarte w planie kontroli przechowywanym w Deutsches Institut für Bauechnik.

Dokument wydany w Berlinie 13 lipca 2020r. przez Deutsches Institut für Bauechnik.

Dr Inż. Lars Eckfeldt  
Z upoważnienia Kierownika Działu

uwierzytelnione przez:  
Lange



## Warunki montażu

### Rysunek A1:

Metalowa kotwa rozporowa Hilti HST, HST-R oraz HST-HCR

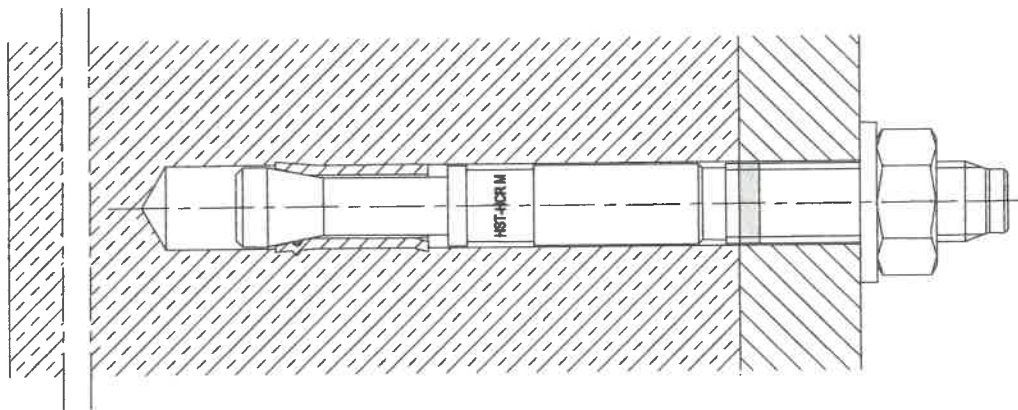

### Rysunek A2:

Metalowa kotwa rozporowa Hilti HST3 oraz HST3-R ze standardową oraz zmniejszoną głębokością osadzania

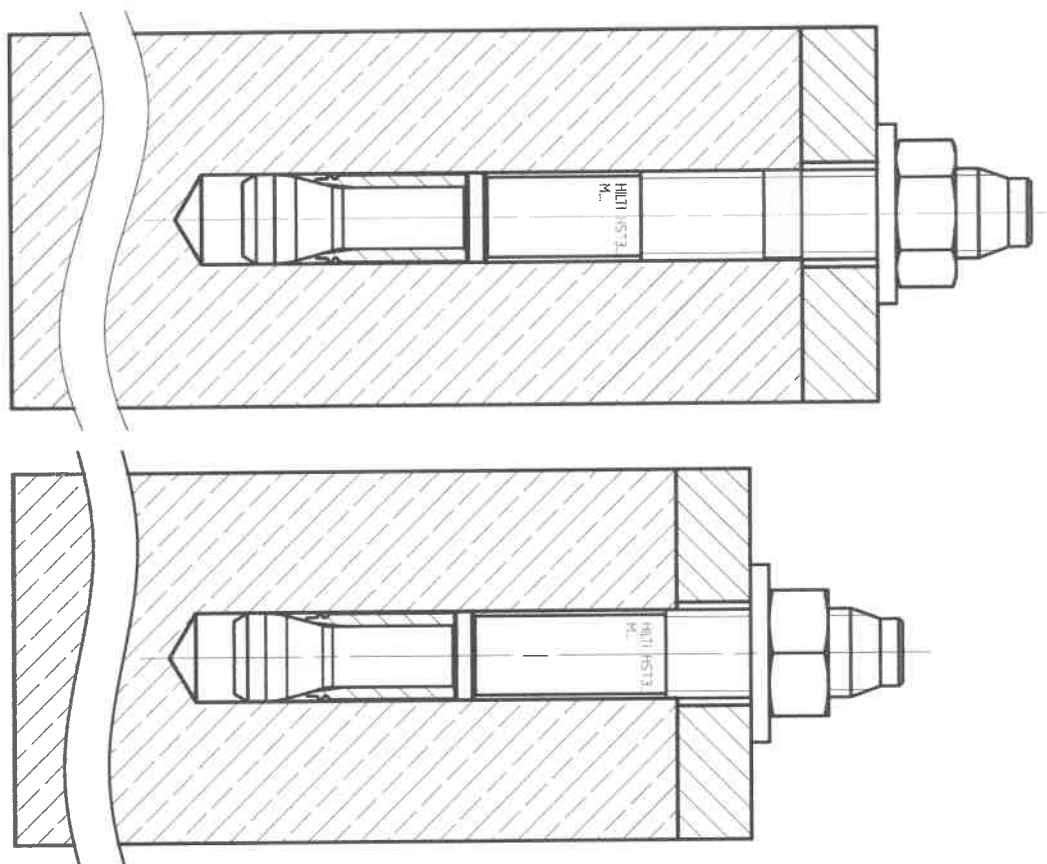

Metalowa kotwa rozporowa Hilti HST, HST-R, HST-HCR, HST3, HST3-R

Opis produktu  
Warunki montażu



**Rysunek A3:**

**Metalowa kotwa rozporowa Hilti HST3 oraz HST3-R z zestawem do wypełniania (Filling Set)**

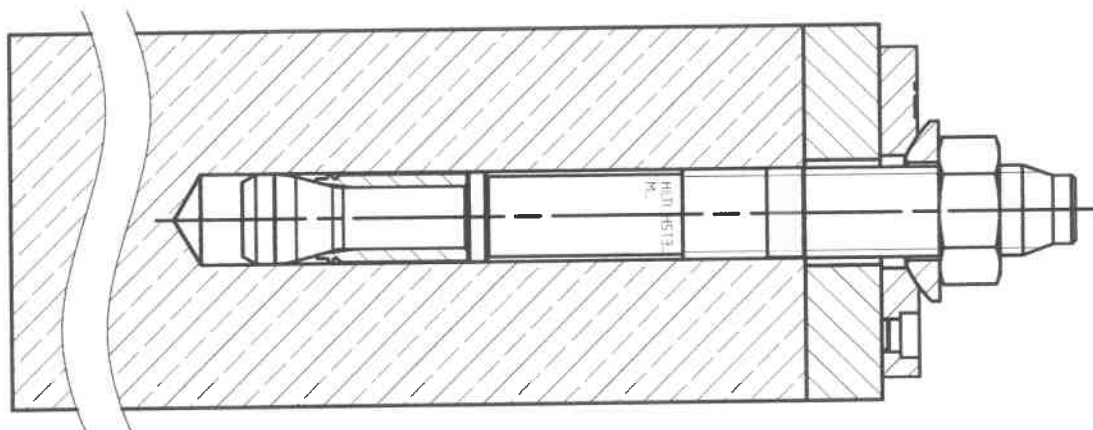

**Metalowa kotwa rozporowa Hilti HST, HST-R, HST-HCR, HST3, HST3-R**

**Opis produktu**  
Warunki montażu



## Opis produktu: metalowa kotwa rozporowa Hilti HST, HST-R oraz HST-HCR

### Wersja formowana na zimno

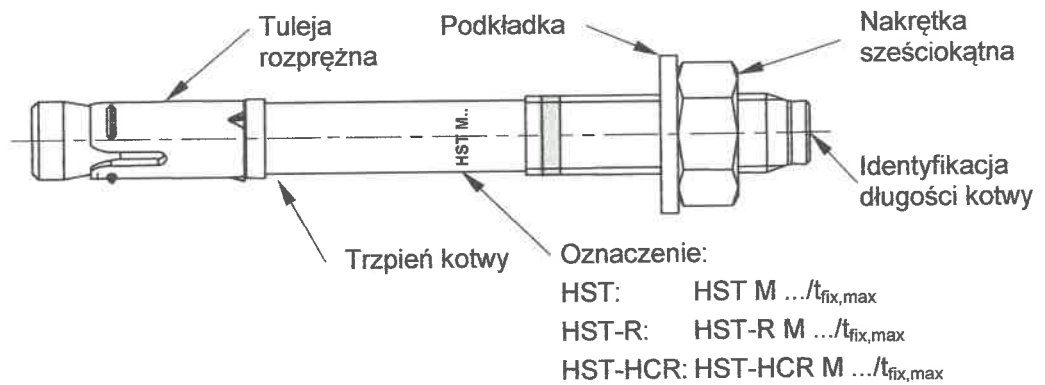

### Wersja wykonana w procesie obróbki skrawaniem

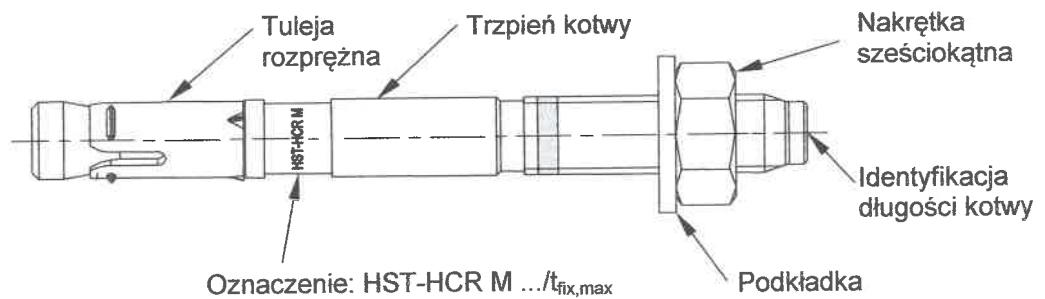

## Metalowa kotwa rozporowa Hilti HST, HST-R, HST-HCR, HST3, HST3-R

### Opis produktu

Typy kotew, oznaczenia oraz identyfikacja kotew





## Opis produktu: metalowa kotwa rozporowa Hilti HST3 oraz HST3-R

### Wersja formowana na zimno

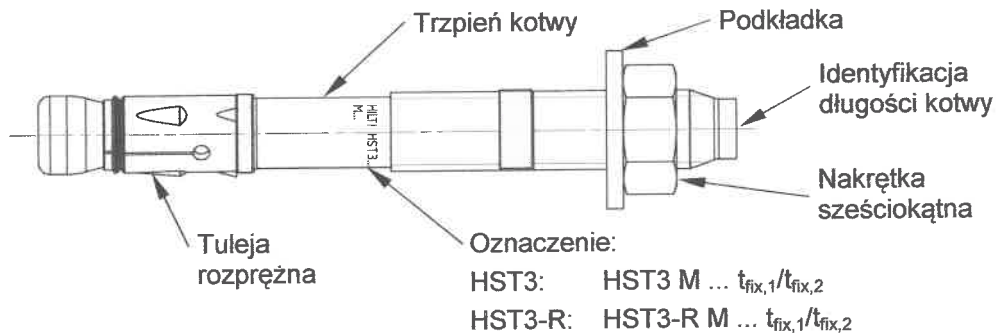

### Wersja wykonana w procesie obróbki skrawaniem M8 - M16

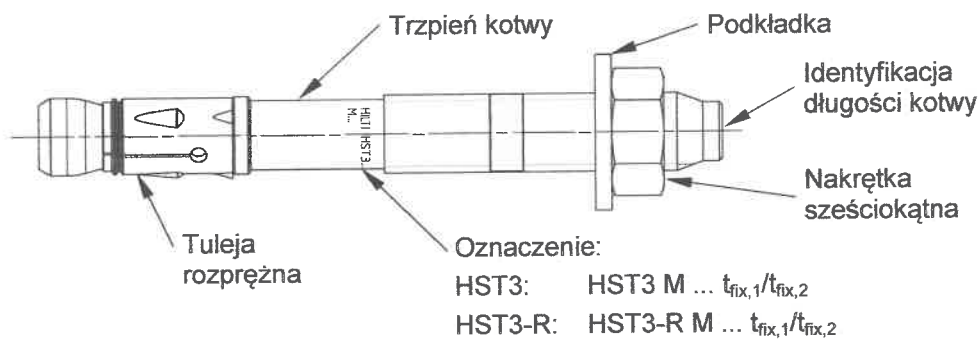

### Wersja wykonana w procesie obróbki skrawaniem M20 - M24

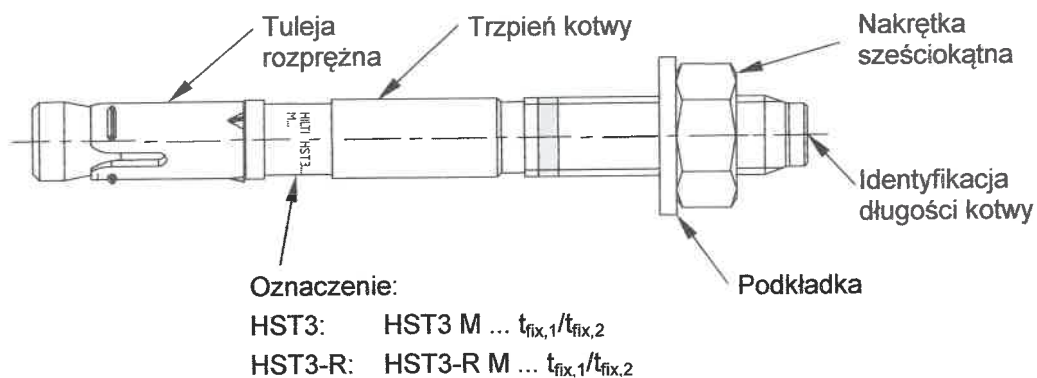

## Metalowa kotwa rozporowa Hilti HST, HST-R, HST-HCR, HST3, HST3-R

Opis produktu  
 Typy kotew, oznaczenia oraz identyfikacja kotew



**Tabela A1: Identyfikacja długości kotew HST, HST3, HST-R, HST3-R, HST-HCR**

Litera		A	B	C	D	E	f	II
Długość kotwy	≥ [mm]	38,1	50,8	63,5	76,2	88,9	100,0	100,0
	< [mm]	50,8	63,5	76,2	88,9	101,6	100,0	100,0

Litera		F	G	Δ	H	I	J	K
Długość kotwy	≥ [mm]	101,6	114,3	125,0	127,0	139,7	152,4	165,1
	< [mm]	114,3	127,0	125,0	139,7	152,4	165,1	177,8

Litera		L	M	N	O	P	Q	R
Długość kotwy	≥ [mm]	177,8	190,5	203,2	215,9	228,6	241,3	254,0
	< [mm]	190,5	203,2	215,9	228,6	241,3	254,0	279,4

Litera		r	S	T	U	V	W	X
Długość kotwy	≥ [mm]	260,0	279,4	304,8	330,2	355,6	381,0	406,4
	< [mm]	260,0	304,8	330,2	355,6	381,0	406,4	431,8

Litera		Y	Z	AA	BB	CC	DD	EE
Długość kotwy	≥ [mm]	431,8	457,2	482,6	508,0	533,4	558,8	584,2
	< [mm]	457,2	482,6	508,0	533,4	558,8	584,2	609,6

Litera		FF	GG	HH	II	JJ	KK	LL
Długość kotwy	≥ [mm]	609,6	635,0	660,4	685,8	711,2	736,6	762,0
	< [mm]	635,0	660,4	685,8	711,2	736,6	762,0	787,4

Litera		MM	NN	OO	PP	QQ	RR	SS
Długość kotwy	≥ [mm]	787,4	812,8	838,2	863,6	889,0	914,4	939,8
	< [mm]	812,8	838,2	863,6	889,0	914,4	939,8	965,2

Litera		TT	UU	VV
Długość kotwy	≥ [mm]	965,2	990,6	1016,0
	< [mm]	990,6	1016,0	1041,4

**Metalowa kotwa rozporowa Hilti HST, HST-R, HST-HCR, HST3, HST3-R**

**Opis produktu**  
Typy kotew, oznaczenia oraz identyfikacja kotew



Tabela A2: Materiały

Opis elementu	Materiał
<b>HST (stal węglowa)</b>	
Tuleja rozprężna	Stal nierdzewna A4 według normy EN 10088-1:2014
Trzpień kotwy	Stal węglowa, ocynkowana galwanicznie, powlekana (przezroczysta), wydłużenie przy zerwaniu ( $l_0 = 5d$ ) > 8 %
Podkładka	Stal węglowa, ocynkowana galwanicznie
Nakrętka sześciokątna	Stal węglowa, ocynkowana galwanicznie
<b>HST-R (stal nierdzewna)</b>	
<b>Klasa odporności na korozję III według normy EN 1993-1-4:2006+A1:2015</b>	
Tuleja rozprężna	Stal nierdzewna A4 według normy EN 10088-1:2014
Trzpień kotwy	Stal nierdzewna A4 według normy EN 10088-1:2014, stożek powlekany (czerwony lub przezroczysty), wydłużenie przy zerwaniu ( $l_0 = 5d$ ) > 8 %
Podkładka	Stal nierdzewna A4 według normy DIN EN ISO 3506-1:2010
Nakrętka sześciokątna	Stal nierdzewna A4 według normy DIN EN ISO 3506-1:2010, powlekana
<b>HST-HCR (stal o wysokiej odporności na korozję)</b>	
<b>Klasa odporności na korozję V według normy EN 1993-1-4:2006+A1:2015</b>	
Tuleja rozprężna	Stal nierdzewna A4 według normy EN 10088-1:2014
Trzpień kotwy	Stal o wysokiej odporności na korozję według normy EN 10088-1:2014, stożek powlekany (czerwony) wydłużenie przy zerwaniu ( $l_0 = 5d$ ) > 8 %
Podkładka	Stal o wysokiej odporności na korozję według normy EN 10088-1:2014
Nakrętka sześciokątna	Stal o wysokiej odporności na korozję według normy EN 10088-1:2014, powlekana

Metalowa kotwa rozporowa Hilti HST, HST-R, HST-HCR, HST3, HST3-R

Opis produktu  
Materiały

Załącznik A6





## Tabela A2 ciąg dalszy

Opis elementu	Materiał
<b>HST3 (stal węglowa)</b>	
Tuleja rozprężna	M10, M16: stal węglowa, ocynkowana galwanicznie lub stal nierdzewna według normy EN 10088-1:2014 M8, M12, M20, M24: stal nierdzewna
Trzpień kotwy	Stal węglowa, ocynkowana galwanicznie, powlekana (przezroczysta), wydłużenie przy zerwaniu ( $l_0 = 5d$ ) > 8 %
Podkładka	Stal węglowa, ocynkowana galwanicznie
Nakrętka sześciokątna	Stal węglowa, ocynkowana galwanicznie
<b>Zestaw do wypełniania (stal węglowa)</b>	
Podkładka uszczelniająca	Stal węglowa, ocynkowana galwanicznie
Podkładka sferyczna	Stal węglowa, ocynkowana galwanicznie
<b>HST3-R (stal nierdzewna)</b>	
<b>Klasa odporności na korozję III według normy EN 1993-1-4:2006+A1:2015</b>	
Tuleja rozprężna	Stal nierdzewna A4 według normy EN 10088-1:2014
Trzpień kotwy	Stal nierdzewna A4 według normy EN 10088-1:2014, stożek powlekany (powłoka przezroczysta), wydłużenie przy zerwaniu ( $l_0 = 5d$ ) > 8 %
Podkładka	Stal nierdzewna A4 według normy EN 10088-1:2014
Nakrętka sześciokątna	Stal nierdzewna A4 według normy EN 10088-1:2014, powlekana
<b>Zestaw do wypełniania (stal nierdzewna)</b>	
<b>Klasa odporności na korozję III według normy EN 1993-1-4:2006+A1:2015</b>	
Podkładka uszczelniająca	Stal nierdzewna A4 według normy ASTM A 240/A 240M:2019
Podkładka sferyczna	Stal nierdzewna A4 według normy EN 10088-1:2014

**Metalowa kotwa rozporowa Hilti HST, HST-R, HST-HCR, HST3, HST3-R**

Opis produktu  
 Materiały



## Żywica iniekcyjna Hilti HIT-HY 200-A

System hybrydowy (dwuskładnikowy) z żywicą, utwardzaczem, cementem oraz wodą  
Ładunek foliowy o objętości 330 ml oraz 500 ml

Oznaczenie:  
HILTI HIT  
Numer produkcyjny oraz  
numer linii produkcyjnej  
Data ważności m-c/rok



Nazwa produktu: "Hilti HIT-HY 200-A"

## Mieszacz statyczny Hilti HIT-RE-M



## Dozowniki



Hilti HDM 330



Hilti HDE 500

## Tabela A3: czas utwardzania żywicy Hilti HIT-HY 200-A

Temperatura w podłożu / otoczenia	Czas utwardzania $t_{cure}$ Hilti HIT-HY 200-A
od -10 °C do -5 °C	7 godzin
od -4 °C do 0 °C	4 godziny
od 1 °C do 5 °C	2 godziny
od 6 °C do 10 °C	75 minut
od 11 °C do 20 °C	45 minut
od 21 °C do 30 °C	30 minut
od 31 °C do 40 °C	30 minut

Metalowa kotwa rozporowa Hilti HST, HST-R, HST-HCR, HST3, HST3-R

Opis produktu  
Żywica iniekcyjna

Załącznik A8



**Tabela A4: Wymiary kotew HST, HST-R oraz HST-HCR**

HST, HST-R, HST-HCR		M8	M10	M12	M16	M20 <sup>1)</sup>	M24 <sup>1)</sup>
Maksymalna długość kotwy	$l_{maks.} \leq$ [mm]	260	280	295	350	450	500
Średnica trzpienia przy stożku	$d_R$ [mm]	5,5	7,2	8,5	11,6	14,6	17,4
Długość tulei rozprężnej	$l_S$ [mm]	14,8	18,2	22,7	24,3	28,3	36,0

<sup>1)</sup> Wyłącznie kotwa HST i HST-R

**HST, HST-R oraz HST-HCR**

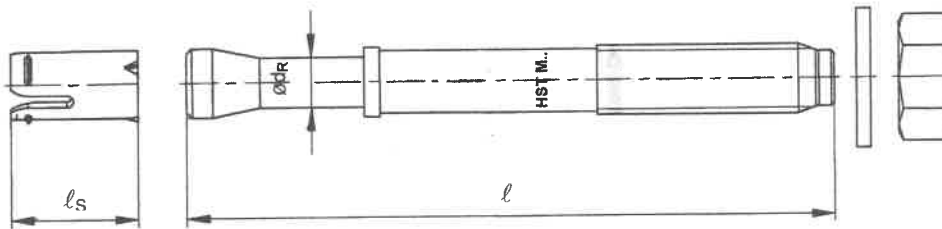

**Tabela A5: Wymiary kotew HST3 oraz HST3-R**

HST3, HST3-R		M8	M10	M12	M16	M20	M24
Maksymalna długość kotwy	$l_{maks.} \leq$ [mm]	260	280	350	475	450	500
Średnica trzpienia przy stożku	$d_R$ [mm]	5,60	6,94	8,22	11,00	14,62	17,4
Długość tulei rozprężnej	$l_S$ [mm]	13,6	16,0	20,0	25,0	28,3	36,0
Średnica podkładki	$d_W \geq$ [mm]	15,57	19,48	23,48	29,48	36,38	43,38

**HST3 oraz HST3-R**

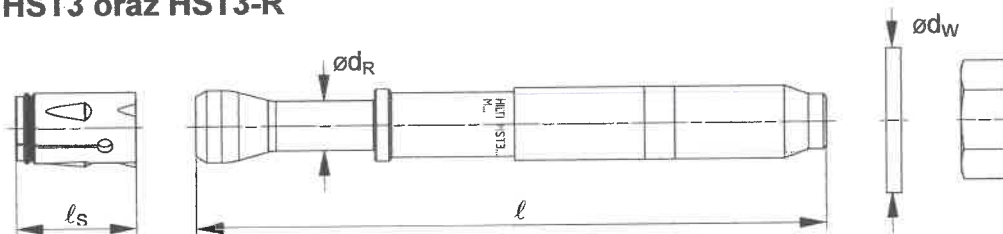

**Metalowa kotwa rozporowa Hilti HST, HST-R, HST-HCR, HST3, HST3-R**

Opis produktu  
Wymiary kotew

Załącznik A9



**Zestaw do wypełniania (Filling Set) pierścieniowej przestrzeni pomiędzy kotwą i elementem mocowanym**

**Tabela A6: Wymiary zestawu do wypełniania (Filling Set)**

Zestaw sejsmiczny/do wypełniania stosowany z kotwami HST3, HST3-R	M8	M10	M12	M16	M20
Średnica podkładki uszczelniającej $d_{vs}$ [mm]	38	42	44	52	60
Grubość podkładki uszczelniającej $h_{vs}$ [mm]	5			6	

Podkładka uszczelniająca

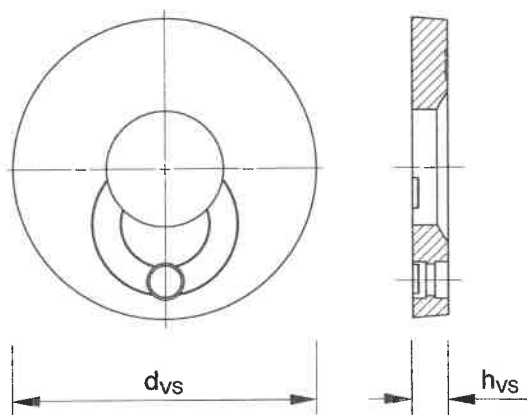

Podkładka sferyczna

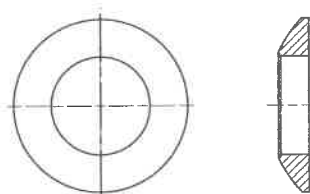

**Metalowa kotwa rozporowa Hilti HST, HST-R, HST-HCR, HST3, HST3-R**

Opis produktu  
 Wymiary



## Szczegóły techniczne zamierzonego stosowania

### Materiały podłoża:

- Zagęszczony zbrojony lub niezbrojony beton o standardowym ciężarze zgodny z normą EN 206:2013 + A1:2016
- Klasy wytrzymałości betonu od C20/25 do C50/60 zgodnie z normą EN 206:2013 + A1:2016
- Beton zarysowany i beton niezarysowany

### Warunki stosowania (warunki środowiskowe):

- Konstrukcje poddane oddziaływaniu warunków suchych wewnątrz budowli (wszystkie materiały)
- Dla wszelkich pozostałych warunków według EN 1993-1-4:2006 + A1:2015 odpowiadających klasom odporności na korozję zawartym w Tabeli A1 Załącznika A6 (stałe nierdzewne).

### Projektowanie:

- Zakotwienia muszą być zaprojektowane pod nadzorem inżyniera doświadczonego w dziedzinie zakotwień i robót betonowych.
- Należy wykonać możliwe do weryfikacji obliczenia oraz opracować rysunki, biorąc pod uwagę obciążenia, które mają być przeniesione przez kotwy. Położenie kotew musi być określone na rysunkach projektowych (np. poprzez podanie położenia kotwy względem zbrojenia lub względem podpór, itd).
- Zakotwienia muszą być zaprojektowane zgodnie z:  
normą EN 1992-4:2018 oraz zgodnie z Raportem Technicznym EOTA TR 055, wydanie z grudnia 2016r.
- W przypadku wymagań odnośnie odporności ogniowej należy wyeliminować możliwość miejscowego odspojenia się otuliny betonu.

**Metalowa kotwa rozporowa Hilti HST, HST-R, HST-HCR, HST3, HST3-R**

**Szczegóły techniczne zamierzonego stosowania**









**Montaż:**

- Montaż kotew może być przeprowadzony wyłącznie przez odpowiednio wykwalifikowany personel oraz pod odpowiednim nadzorem osoby odpowiedzialnej za kwestie techniczne na budowie.
- Każda kotwa może być osadzona tylko raz.
- Montaż w pozycji 'nad głową' jest dopuszczalny.



**Tabela B1: Techniki wiercenia otworów dla kotwy HST, HST-R oraz HST-HCR**

HST, HST-R oraz HST-HCR		M8	M10	M12	M16	M20 <sup>1)</sup>	M24 <sup>1)</sup>
Wiercenie udarowe (HD)		✓	✓	✓	✓	✓	✓

<sup>1)</sup>Wyłącznie kotwa HST i HST-R**Tabela B2: Techniki wiercenia otworów dla kotwy HST3 oraz HST3-R**

HST3, HST3-R		M8	M10	M12	M16	M20	M24
Wiercenie udarowe (HD)		✓	✓	✓	✓	✓	✓
Wiercenie diamentowe rdzeniowe (DD) przy użyciu <ul style="list-style-type: none"> <li>• wiertnicy DD EC-1 oraz wiertel DD-C ... TS/TL oraz wiertel DD-C ... T2/T4</li> <li>• wiertnicy DD 30-W oraz wiertel C+ ... SPX-T (abrazyjne)</li> </ul>		✓	✓	✓	✓	✓	✓
Wiercenie udarowe przy użyciu wiertel rurowych Hilti TE-CD/YD ... system wiercenia (HDB)		-	-	✓	✓	✓	✓

**Tabela B3: Metody czyszczenia wierconych otworów**

<b>Czyszczenie ręczne (MC):</b> Ręczna pompka Hilti do wydmuchiwania zwiercin	
<b>Czyszczenie przy użyciu sprężonego powietrza (CAC):</b> Dysza do sprężonego powietrza z otworem wylotowym o średnicy co najmniej 3,5 mm.	
<b>Czyszczenie automatyczne (AC):</b> Czyszczenie odbywa się w trakcie wiercenia przy użyciu systemu Hilti TE-CD oraz TE-YD wyposażonego w odkurzacze przemysłowe.	

**Metalowa kotwa rozporowa Hilti HST, HST-R, HST-HCR, HST3, HST3-R**

Szczegóły techniczne zamierzonego stosowania





**Tabela B4: Metody przykładania momentu dokręcającego dla kotew HST, HST-R oraz HST-HCR**

HST, HST-R oraz HST-HCR	M8	M10	M12	M16	M20 <sup>1)</sup>	M24 <sup>1)</sup>
Klucz dynamometryczny 	✓	✓	✓	✓	✓	✓

<sup>1)</sup> Wyłącznie kotwa HST i HST-R

**Tabela B5: Metody przykładania momentu dokręcającego dla kotew HST3 oraz HST3-R**

HST3, HST3-R	M8	M10	M12	M16	M20	M24
Klucz dynamometryczny 	✓	✓	✓	✓	✓	✓
Maszynowe dokręcanie przy użyciu wkrętarci udarowej Hilti SIW 6AT 22A wyposażonej w moduł do dokręcania SI-AT-A22 	✓	✓	✓	-	-	-

**Tabela B6: Przegląd kategorii użytkowania oraz kategorii właściwości HST, HST-R oraz HST-HCR**

Zakotwienia poddawane:	HST, HST-R, HST-HCR
Obciążenia statyczne i quasi-statyczne	od M8 do M24 (HST oraz HST-R) od M8 do M16 (HST-HCR) Tabela : C1, C3, C5
Kategoria właściwości sejsmicznych C1/C2	od M10 do M16 (HST oraz HST-R) Tabela : C7, C9, C11, C12, C15, C16
Obciążenia statyczne i quasi-statyczne przy wymogu odporności ogniowej	od M8 do M24 Tabela : C19, C21

**Tabela B7: Przegląd kategorii użytkowania oraz kategorii właściwości HST3 oraz HST3-R**

Zakotwienia poddawane:	HST3, HST3-R
Obciążenia statyczne i quasi-statyczne	od M10 do M16 (dla $h_{ef,1}$ ) od M8 do M24 (dla $h_{ef,2}$ ) Tabela : C2, C4, C6
Kategoria właściwości sejsmicznych C1/C2	od M8 do M20 (dla $h_{ef,2}$ ) M12 (dla $h_{ef,1}$ ) Tabela : C8, C10, C13, C14, C17, C18
Obciążenia statyczne i quasi-statyczne przy wymogu odporności ogniowej	od M10 do M16 (dla $h_{ef,1}$ ) od M8 do M24 (dla $h_{ef,2}$ ) Tabela : C20, C22

**Metalowa kotwa rozporowa Hilti HST, HST-R, HST-HCR, HST3, HST3-R**

**Szczegóły techniczne zamierzonego stosowania**

Załącznik B3

**Tabela B8: Parametry montażowe dla kotew HST, HST-R oraz HST-HCR**

HST, HST-R, HST-HCR			M8	M10	M12	M16	M20 <sup>1)</sup>	M24 <sup>1)</sup>
Nominalna średnica wiertła	$d_0$	[mm]	8	10	12	16	20	24
Średnica tnąca wiertła	$d_{cut} \leq$	[mm]	8,45	10,45	12,50	16,50	20,55	24,55
Głębokość wierconego otworu	$h_1 \geq$	[mm]	65	80	95	115	140	170
Czynna głębokość osadzenia	$h_{ef}$	[mm]	47	60	70	82	101	125
Długość włączenia gwintu	$h_{nom}$	[mm]	55	69	80	95	117	143
Maksymalna średnica otworu w elemencie mocowanym <sup>2)</sup>	$d_f$	[mm]	9	12	14	18	22	26
Montażowy moment dokręcający	$T_{inst}$	[Nm]	20	45	60	110	240	300
Maksymalna grubość elementu mocowanego	$t_{fix,max} \leq$	[mm]	195	200	200	235	305	330
Rozwartość klucza (do nakrętki)	SW	[mm]	13	17	19	24	30	36

<sup>1)</sup> Wyłącznie kotwa HST i HST-R

<sup>2)</sup> Dla projektowania większych otworów przelotowych w elemencie mocowanym patrz → norma EN 1992-4:2018.

**Metalowa kotwa rozporowa Hilti HST, HST-R, HST-HCR, HST3, HST3-R**

**Zamierzone stosowanie**  
 Parametry montażowe





Tabela B9: Parametry montażowe dla kotew HST3 oraz HST3-R

HST3, HST3-R			M8	M10	M12	M16	M20	M24
Nominalna średnica wiertła	$d_0$	[mm]	8	10	12	16	20	24
Średnica tnąca wiertła dla wiertarki udarowej	$d_{cut} \leq$	[mm]	8,45	10,45	12,50	16,50	20,55	24,55
Głębokość wierconego otworu <sup>1)</sup>	$h_{1,1} \geq$	[mm]	-	53	68	86	-	-
Czynna głębokość osadzenia	$h_{ef,1}$	[mm]	-	40	50	65	-	-
Długość włączenia gwintu	$h_{nom,1}$	[mm]	-	48	60	78	-	-
Głębokość wierconego otworu <sup>1)</sup>	$h_{1,2} \geq$	[mm]	59	73	88	106	124	151
Czynna głębokość osadzenia	$h_{ef,2}$	[mm]	47	60	70	85	101	125
Długość włączenia gwintu	$h_{nom,2}$	[mm]	54	68	80	98	116	143
Maksymalna średnica otworu w elemencie mocowanym <sup>2)</sup>	$d_f$	[mm]	9	12	14	18	22	26
Montażowy moment dokręcający	$T_{inst}$	[Nm]	20	45	60	110	180	300
Maksymalna grubość elementu mocowanego	$t_{fix,max}$	[mm]	195	220	270	370	310	330
Rozwartość klucza (do nakrętki)	SW	[mm]	13	17	19	24	30	36

<sup>1)</sup> W przypadku wiercenia techniką diamentową + 5 mm dla M8 do M10 oraz + 2 mm dla M12 do M24

<sup>2)</sup> Dla projektowania większych otworów przelotowych w elemencie mocowanym patrz → norma EN 1992-4:2018.

**Metalowa kotwa rozporowa Hilti HST, HST-R, HST-HCR, HST3, HST3-R**

**Zamierzone stosowanie**  
Parametry montażowe



### Kotwa HST, HST-R oraz HST-HCR

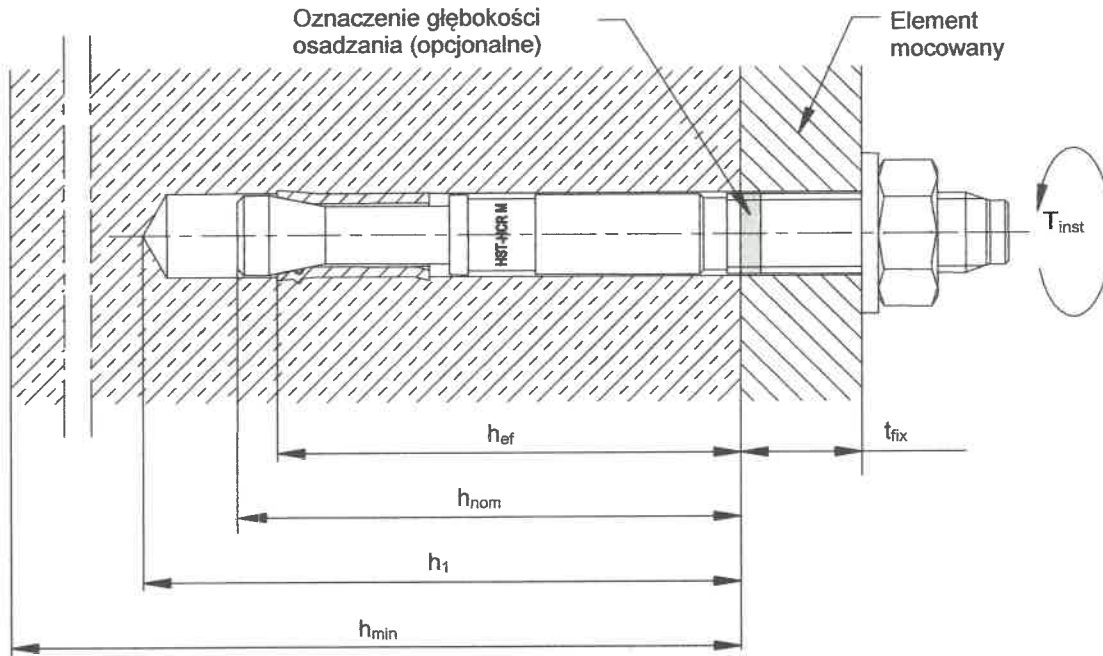

### Kotwa HST3 oraz HST3-R (standardowa głębokość osadzenia)

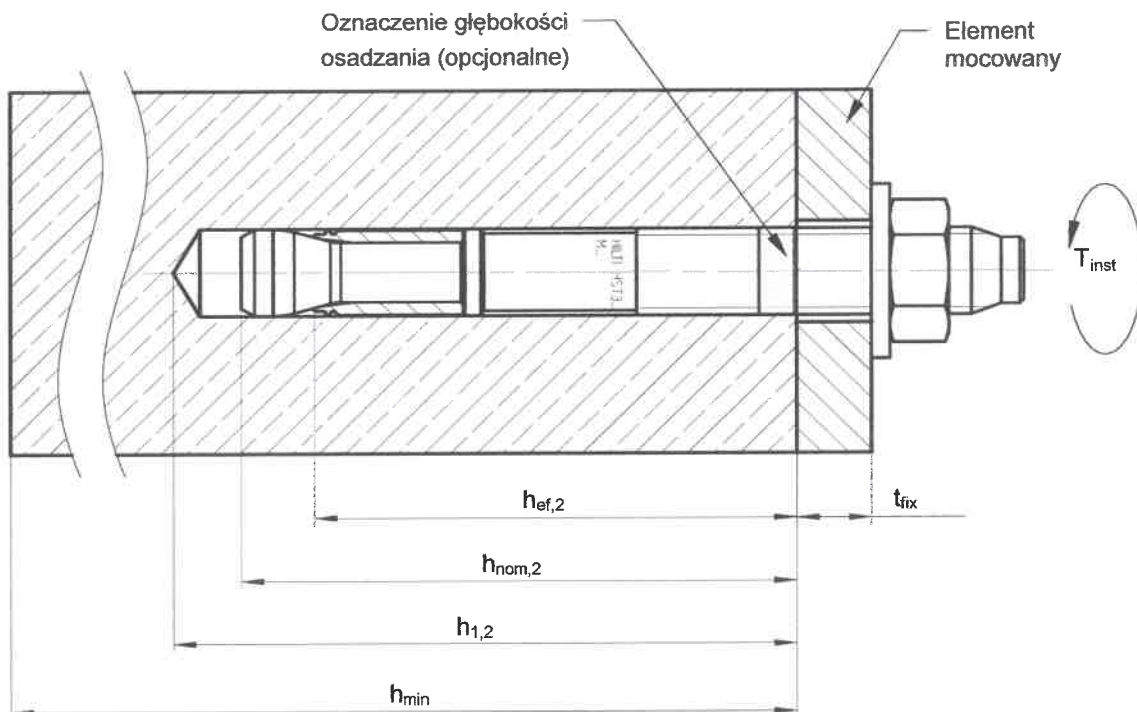

**Metalowa kotwa rozporowa Hilti HST, HST-R, HST-HCR, HST3, HST3-R**

**Zamierzone stosowanie**  
**Parametry montażowe**



### Kotwa HST3 oraz HST3-R (zmniejszona głębokość osadzenia)

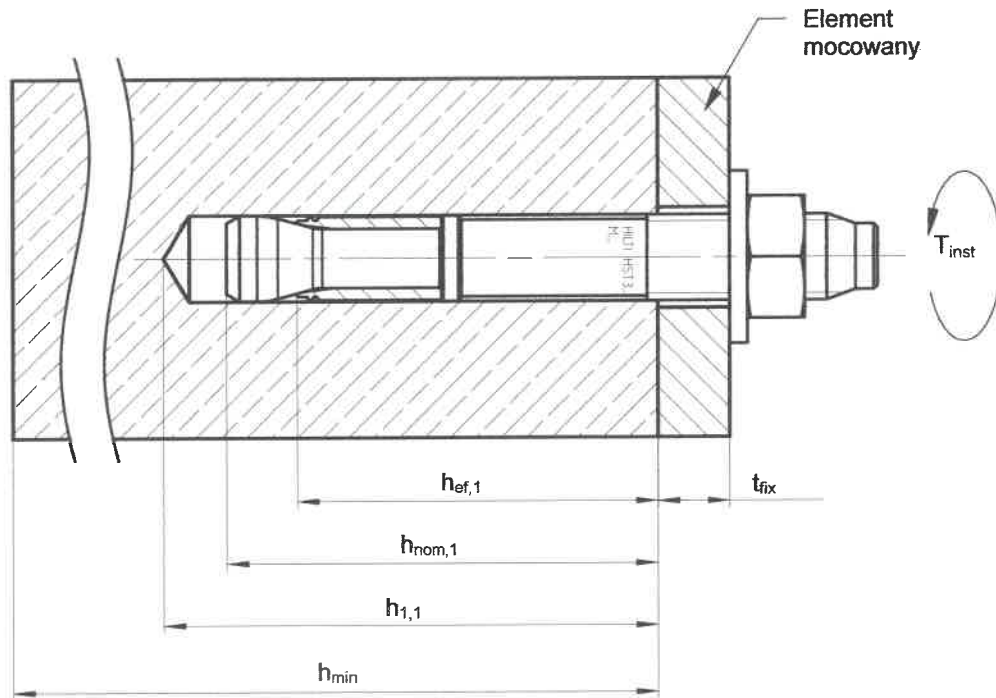

### Kotwa HST3 oraz HST3-R z zestawem do wypełniania (Filling Set) pierścieniowej przestrzeni między kotwą i elementem mocowanym

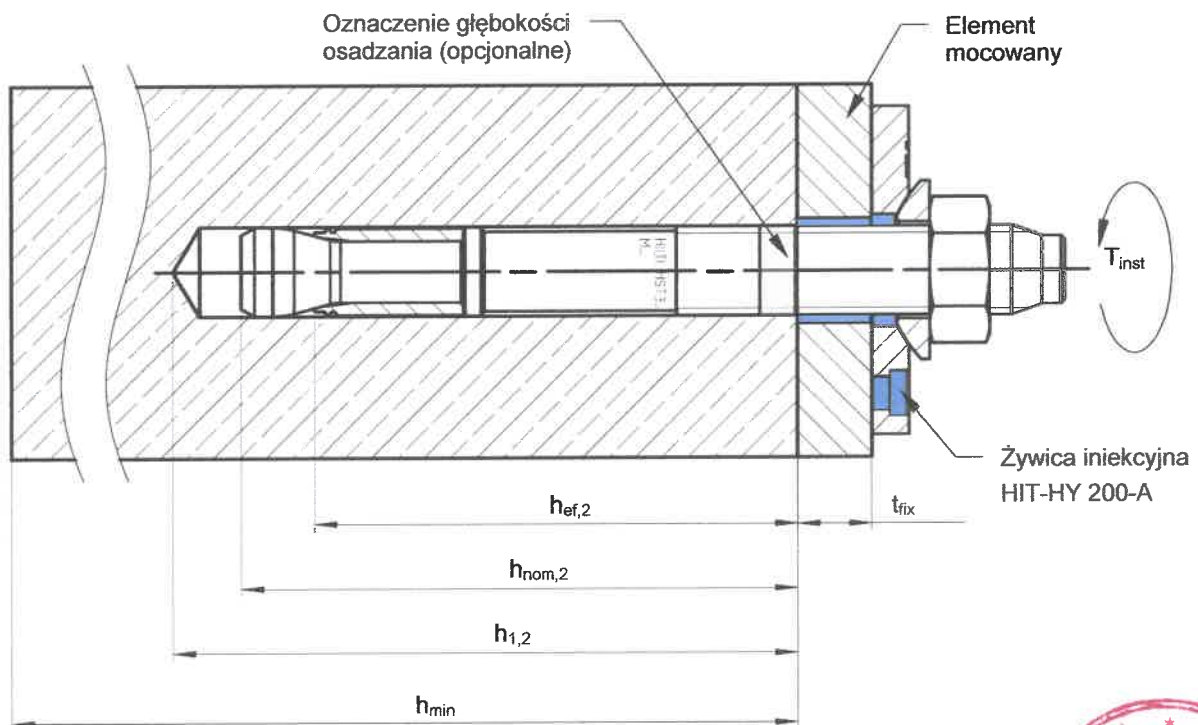

Metalowa kotwa rozporowa Hilti HST, HST-R, HST-HCR, HST3, HST3-R

Zamierzone stosowanie  
Parametry montażowe



**Tabela B10: Minimalny rozstaw kotew oraz minimalna odległość od krawędzi podłoża dla kotew HST, HST-R oraz HST-HCR**

		M8	M10	M12	M16	M20 <sup>1)</sup>	M24 <sup>1)</sup>
Minimalna grubość elementu betonowego	$h_{min}$ [mm]	100	120	140	160	200	250
Czynna głębokość osadzenia	$h_{ef}$ [mm]	47	60	70	82	101	125
<b>Beton zarysowany</b>							
<b>HST</b>							
Minimalny rozstaw kotew <sup>2)</sup>	$s_{min}$ [mm]	40	55	60	70	100	125
	dla $c \geq$ [mm]	50	70	75	100	160	180
Minimalna odległość od krawędzi <sup>2)</sup>	$c_{min}$ [mm]	45	55	55	70	100	125
	dla $s \geq$ [mm]	50	90	120	150	225	240
<b>HST-R</b>							
Minimalny rozstaw kotew <sup>2)</sup>	$s_{min}$ [mm]	40	55	60	70	100	125
	dla $c \geq$ [mm]	50	65	75	100	130	130
Minimalna odległość od krawędzi <sup>2)</sup>	$c_{min}$ [mm]	45	50	55	60	100	125
	dla $s \geq$ [mm]	50	90	110	160	160	140
<b>HST-HCR</b>							
Minimalny rozstaw kotew <sup>2)</sup>	$s_{min}$ [mm]	40	55	60	70	3)	3)
	dla $c \geq$ [mm]	50	70	75	100	3)	3)
Minimalna odległość od krawędzi <sup>2)</sup>	$c_{min}$ [mm]	45	50	55	60	3)	3)
	dla $s \geq$ [mm]	50	90	110	160	3)	3)

<sup>1)</sup> Wyłącznie kotwa HST i HST-R

<sup>2)</sup> Dopuszczalna interpolacja liniowa dla  $s_{min}$  oraz  $c_{min}$

<sup>3)</sup> Nie określono parametrów.

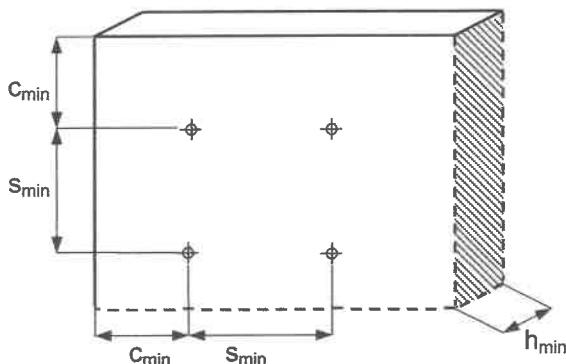

**Metalowa kotwa rozporowa Hilti HST, HST-R, HST-HCR, HST3, HST3-R**

**Zamierzone stosowanie**

Minimalny rozstaw kotew oraz minimalna odległość od krawędzi podłoża





Tabela B10 ciąg dalszy

		M8	M10	M12	M16	M20 <sup>1)</sup>	M24 <sup>1)</sup>
Minimalna grubość elementu betonowego	$h_{min}$ [mm]	100	120	140	160	200	250
Czynna głębokość osadzenia	$h_{ef}$ [mm]	47	60	70	82	101	125
<b>Beton niezarysowany</b>							
<b>HST</b>							
Minimalny rozstaw kotew <sup>2)</sup>	$s_{min}$ [mm]	60	55	60	70	100	125
	dla $c \geq$ [mm]	50	80	85	110	225	255
Minimalna odległość od krawędzi <sup>2)</sup>	$c_{min}$ [mm]	50	55	55	85	140	170
	dla $s \geq$ [mm]	60	115	145	150	270	295
<b>HST-R</b>							
Minimalny rozstaw kotew <sup>2)</sup>	$s_{min}$ [mm]	60	55	60	70	100	125
	dla $c \geq$ [mm]	60	70	80	110	195	205
Minimalna odległość od krawędzi <sup>2)</sup>	$c_{min}$ [mm]	60	50	55	70	140	150
	dla $s \geq$ [mm]	60	115	145	160	210	235
<b>HST-HCR</b>							
Minimalny rozstaw kotew <sup>2)</sup>	$s_{min}$ [mm]	60	55	60	70	3)	3)
	dla $c \geq$ [mm]	50	70	80	110	3)	3)
Minimalna odległość od krawędzi <sup>2)</sup>	$c_{min}$ [mm]	60	55	55	70	3)	3)
	dla $s \geq$ [mm]	60	115	145	160	3)	3)

1) Wyłącznie kotwa HST i HST-R

2) Dopuszczalna interpolacja liniowa dla  $s_{min}$  oraz  $c_{min}$ 

3) Nie określono parametrów.

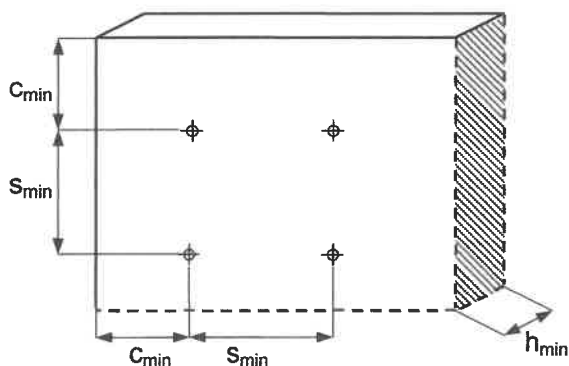

Metalowa kotwa rozporowa Hilti HST, HST-R, HST-HCR, HST3, HST3-R

Zamierzone stosowanie

Minimalny rozstaw kotew oraz minimalna odległość od krawędzi podłoża



**Tabela B11: Minimalny rozstaw kotew oraz minimalna odległość od krawędzi podłoża dla kotew HST3 oraz HST3-R**

		M8	M10	M12	M16	M20	M24
Minimalna grubość elementu betonowego	$h_{min}$ [mm]	100	120	140	160	200	250
Czynna głębokość osadzenia	$h_{ef,2}$ [mm]	47	60	70	85	101	125
<b>Beton zarysowany</b>							
<b>HST3</b>							
Minimalny rozstaw kotew <sup>1)</sup>	$s_{min}$ [mm]	35	40	50	65	90	125
	dla $c \geq$ [mm]	50	55	70	95	130	180
Minimalna odległość od krawędzi <sup>1)</sup>	$c_{min}$ [mm]	40	45	55	65	80	125
	dla $s \geq$ [mm]	50	80	110	150	180	240
<b>HST3-R</b>							
Minimalny rozstaw kotew <sup>1)</sup>	$s_{min}$ [mm]	35	40	50	65	90	125
	dla $c \geq$ [mm]	50	55	70	95	130	130
Minimalna odległość od krawędzi <sup>1)</sup>	$c_{min}$ [mm]	40	45	55	65	80	125
	dla $s \geq$ [mm]	50	80	110	150	180	140

<sup>1)</sup> Dopuszczalna interpolacja liniowa dla  $s_{min}$  oraz  $c_{min}$

<sup>2)</sup> Nie określono parametrów.

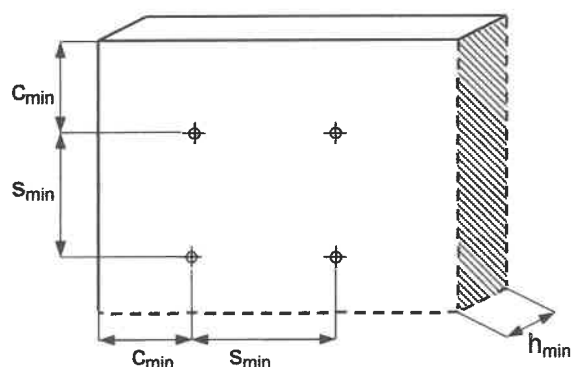

**Metalowa kotwa rozporowa Hilti HST, HST-R, HST-HCR, HST3, HST3-R**

**Zamierzone stosowanie**

Minimalny rozstaw kotew oraz minimalna odległość od krawędzi podłoża

**Załącznik B10**

**Tabela B11 ciąg dalszy**

		M8	M10	M12	M16	M20	M24
Minimalna grubość elementu betonowego	$h_{min}$ [mm]	100	120	140	160	200	250
Czynna głębokość osadzenia	$h_{ef,2}$ [mm]	47	60	70	85	101	125
<b>Beton niezarysowany</b>							
<b>HST3</b>							
Minimalny rozstaw kotew <sup>1)</sup>	$s_{min}$ [mm]	35	40	60	65	90	125
	dla $c \geq$ [mm]	50	60	70	95	130	255
Minimalna odległość od krawędzi <sup>1)</sup>	$c_{min}$ [mm]	40	50	55	65	80	170
	dla $s \geq$ [mm]	50	90	110	150	180	295
<b>HST3-R</b>							
Minimalny rozstaw kotew <sup>1)</sup>	$s_{min}$ [mm]	35	40	60	65	90	125
	dla $c \geq$ [mm]	50	60	70	95	130	205
Minimalna odległość od krawędzi <sup>1)</sup>	$c_{min}$ [mm]	40	50	55	65	80	150
	dla $s \geq$ [mm]	50	90	110	150	180	235

<sup>1)</sup> Dopuszczalna interpolacja liniowa dla  $s_{min}$  oraz  $c_{min}$

<sup>2)</sup> Nie określono parametrów.

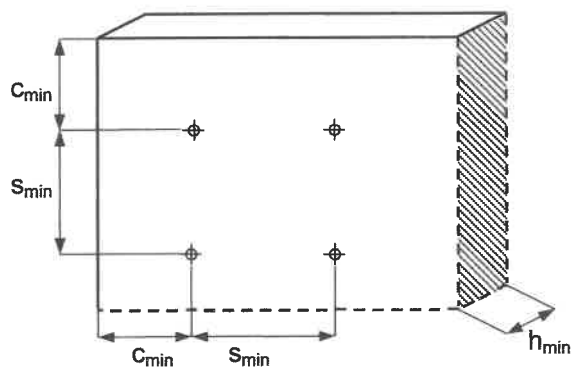

**Metalowa kotwa rozporowa Hilti HST, HST-R, HST-HCR, HST3, HST3-R**

**Zamierzone stosowanie**

Minimalny rozstaw kotew oraz minimalna odległość od krawędzi podłoża



Załącznik B11

**Tabela B11 ciąg dalszy**

			<b>M8</b>	<b>M10</b>	<b>M12</b>	<b>M16</b>	<b>M20</b>	<b>M24</b>
Minimalna grubość elementu betonowego	$h_{min}$	[mm]	80	100	120	140	160	2)
Czynna głębokość osadzenia	$h_{ef,2}$	[mm]	47	60	70	85	101	2)
<b>Beton zarysowany</b>								
<b>HST3 oraz HST3-R</b>								
Minimalny rozstaw kotew <sup>1)</sup>	$s_{min}$	[mm]	35	40	50	80	120	2)
	dla $c \geq$	[mm]	50	100	90	130	180	2)
Minimalna odległość od krawędzi <sup>1)</sup>	$c_{min}$	[mm]	40	60	60	65	120	2)
	dla $s \geq$	[mm]	50	90	120	180	180	2)
<b>Beton niezarysowany</b>								
<b>HST3 oraz HST3-R</b>								
Minimalny rozstaw kotew <sup>1)</sup>	$s_{min}$	[mm]	35	40	50	80	120	2)
	dla $c \geq$	[mm]	55	100	100	130	180	2)
Minimalna odległość od krawędzi <sup>1)</sup>	$c_{min}$	[mm]	40	60	60	65	120	2)
	dla $s \geq$	[mm]	60	90	120	180	180	2)

<sup>1)</sup> Dopuszczalna interpolacja liniowa dla  $s_{min}$  oraz  $c_{min}$

<sup>2)</sup> Nie określono parametrów.

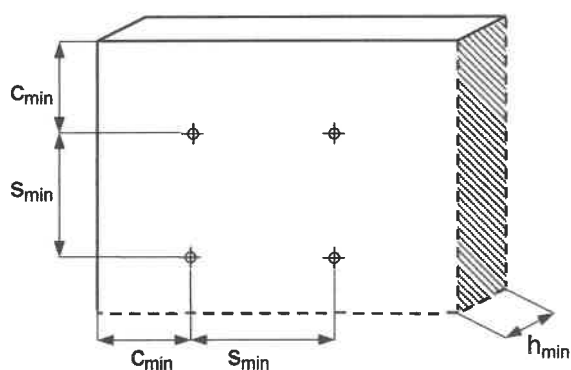

**Metalowa kotwa rozporowa Hilti HST, HST-R, HST-HCR, HST3, HST3-R**

**Zamierzone stosowanie**

Minimalny rozstaw kotew oraz minimalna odległość od krawędzi podłoża





**Tabela B11 ciąg dalszy**

		M8	M10	M12	M16	M20	M24
Minimalna grubość elementu betonowego	$h_{min}$ [mm]	2)	80	100	120	2)	2)
Czynna głębokość osadzenia	$h_{ef,1}$ [mm]	2)	40	50	65	2)	2)
<b>Beton zarysowany</b>							
<b>HST3 oraz HST3-R</b>							
Minimalny rozstaw kotew <sup>1)</sup>	$s_{min}$ [mm]	2)	40	50	65	2)	2)
	dla $c \geq$ [mm]	2)	90	105	130	2)	2)
Minimalna odległość od krawędzi <sup>1)</sup>	$c_{min}$ [mm]	2)	45	55	65	2)	2)
	dla $s \geq$ [mm]	2)	180	210	240	2)	2)
<b>Beton niezarysowany</b>							
<b>HST3 oraz HST3-R</b>							
Minimalny rozstaw kotew <sup>1)</sup>	$s_{min}$ [mm]	2)	50	55	75	2)	2)
	dla $c \geq$ [mm]	2)	95	110	140	2)	2)
Minimalna odległość od krawędzi <sup>1)</sup>	$c_{min}$ [mm]	2)	50	60	65	2)	2)
	dla $s \geq$ [mm]	2)	190	215	240	2)	2)

<sup>1)</sup> Dopuszczalna interpolacja liniowa dla  $s_{min}$  oraz  $c_{min}$

<sup>2)</sup> Nie określono parametrów.

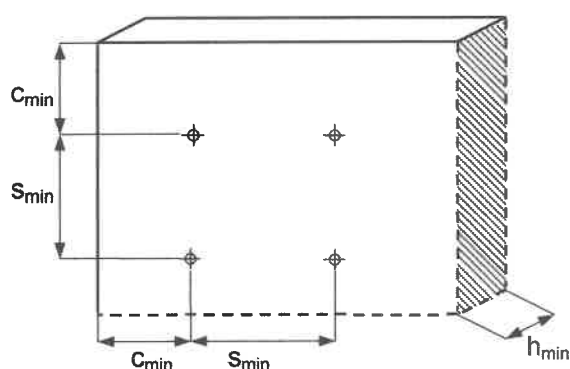

**Metalowa kotwa rozporowa Hilti HST, HST-R, HST-HCR, HST3, HST3-R**

**Zamierzone stosowanie**

Minimalny rozstaw kotew oraz minimalna odległość od krawędzi podłoża

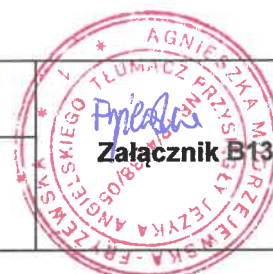

**Instrukcja montażu kotew HST, HST-R oraz HST-HCR****Wiercenie i czyszczenie otworu**

- a) Wiercenie udarowe (HD):  
od M8 do M24

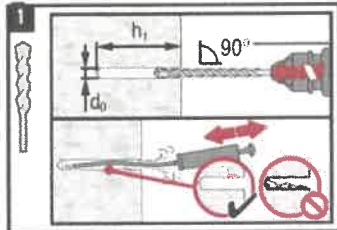
**Osadzanie kotew**

- a) Osadzanie przy pomocy młotka: od M8 do M24      b) Osadzanie maszynowe (narzędzie do osadzania kotew): od M8 do M24

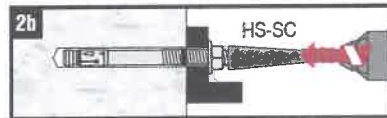
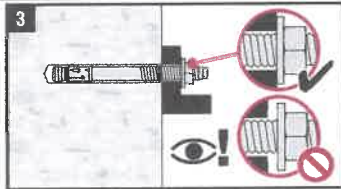
**Kontrola poprawności osadzenia kotew****Dokręcanie kotew momentem dokręcającym**

- a) Kluczem dynamometrycznym:  
od M8 do M24

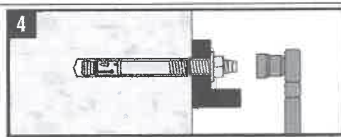

**Metalowa kotwa rozporowa Hilti HST, HST-R, HST-HCR, HST3, HST3-R**

**Zamierzone stosowanie**  
Instrukcje montażu kotew



## Instrukcja montażu kotew HST3 oraz HST3-R

### Wiercenie i czyszczenie otworu

a) Wiercenie udarowe (HD):  
 od M8 do M24

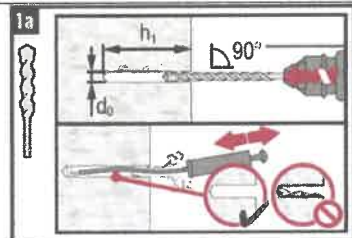

b) Wiercenie diamentowe  
 rdzeniowe (DD): od M8 do M24

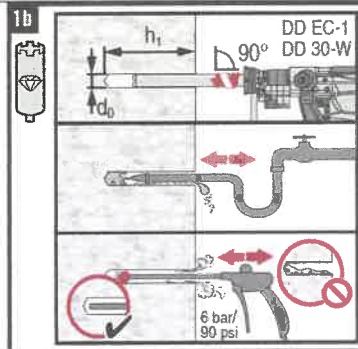

c) Wiercenie udarowe przy użyciu  
 wiertła drażonego Hilti (HDB):  
 od M12 do M24

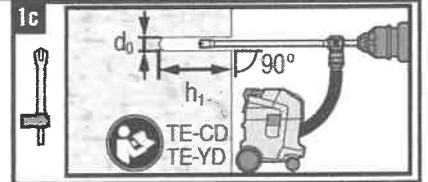

### Osadzanie kotew

a) Osadzanie przy pomocy młotka:

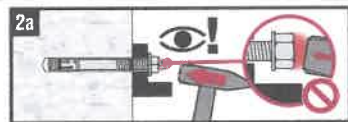

b) Osadzanie maszynowe (narzędzie do osadzania kotew):

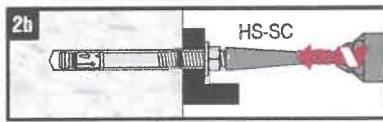

### Kontrola poprawności osadzenia kotew

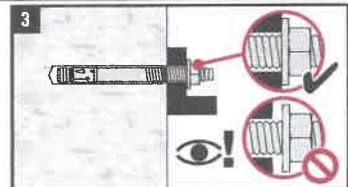

### Dokręcanie kotew momentem dokręcającym

a) Kluczem dynamometrycznym:  
 od M8 do M24

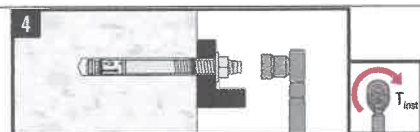

b) Dokręcanie maszynowe:  
 od M8 do M12

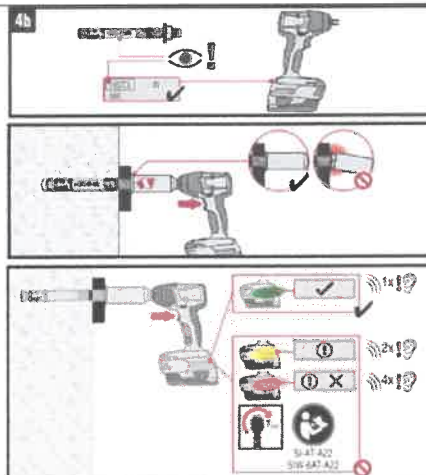

Metalowa kotwa rozporowa Hilti HST, HST-R, HST-HCR, HST3, HST3-R

Zamierzone stosowanie  
 Instrukcje montażu kotew



## Instrukcja montażu kotew HST3 oraz HST3-R z zestawem do wypełniania

### Montaż podkładki uszczelniającej

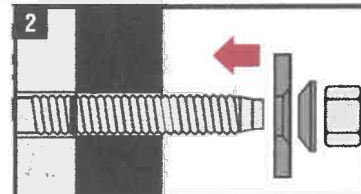
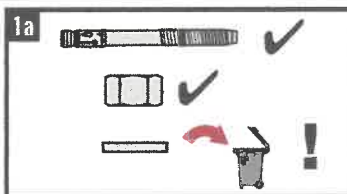

### Dokręcanie kotew momentem dokręcającym

a) Kluczem dynamometrycznym:  
od M8 do M20

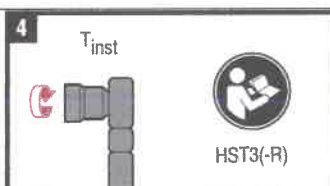
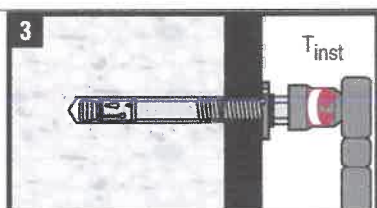

### Montaż nakrętki kontrolującej

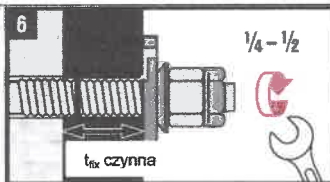
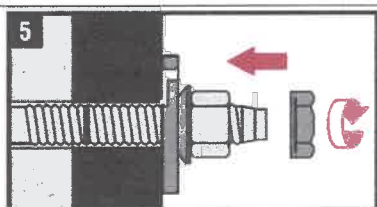

### Dozowanie żywicy iniekcyjnej

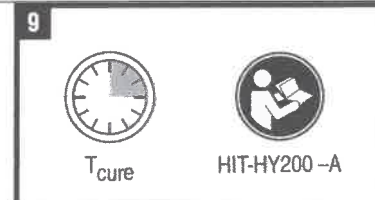
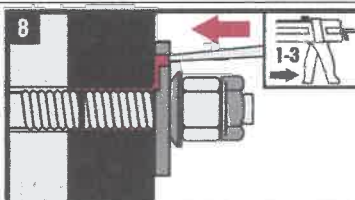
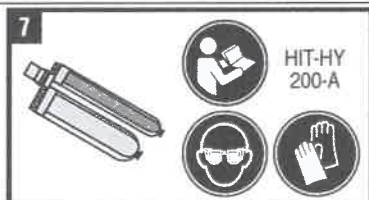

Metalowa kotwa rozporowa Hilti HST, HST-R, HST-HCR, HST3, HST3-R

Zamierzone stosowanie  
Instrukcje montażu kotew





**Tabela C1: Nośność charakterystyczna na rozciąganie dla metalowej kotwy rozporowej Hilti HST, HST-R oraz HST-HCR w betonie zarysowanym i niezarysowanym**

		M8	M10	M12	M16	M20 <sup>1)</sup>	M24 <sup>1)</sup>	
<b>Zniszczenie stali</b>								
<b>HST</b>								
Nośność charakterystyczna	$N_{Rk,s}$ [kN]	19,0	32,0	45,0	76,0	117,0	127,0	
Częściowy współczynnik bezpieczeństwa	$\gamma_{Ms}^{2)}$ [-]	1,50					1,41	
<b>HST-R</b>								
Nośność charakterystyczna	$N_{Rk,s}$ [kN]	17,0	28,0	40,0	69,0	109,0	156,0	
Częściowy współczynnik bezpieczeństwa	$\gamma_{Ms}^{2)}$ [-]	1,50			1,56	1,73		
<b>HST-HCR</b>								
Nośność charakterystyczna	$N_{Rk,s}$ [kN]	19,4	32,3	45,7	84,5	3)	3)	
Częściowy współczynnik bezpieczeństwa	$\gamma_{Ms}^{2)}$ [-]	1,50				3)	3)	
<b>Zniszczenie przez wyciągnięcie kotwy</b>								
<b>HST</b>								
Nośność charakterystyczna w betonie zarysowanym klasy C20/25	$N_{Rk,p}$ [kN]	5,0	9,0	12,0	20,0	30,0	40,0	
Nośność charakterystyczna w betonie niezarysowanym klasy C20/25	$N_{Rk,p}$ [kN]	9,0	16,0	20,0	35,0	50,0	60,0	
Montażowy współczynnik bezpieczeństwa	$\gamma_{inst}$ [-]	1,20	1,00					
<b>HST-R</b>								
Nośność charakterystyczna w betonie zarysowanym klasy C20/25	$N_{Rk,p}$ [kN]	5,0	9,0	12,0	25,0	30,0	40,0	
Nośność charakterystyczna w betonie niezarysowanym klasy C20/25	$N_{Rk,p}$ [kN]	9,0	16,0	20,0	35,0	50,0	60,0	
Montażowy współczynnik bezpieczeństwa	$\gamma_{inst}$ [-]	1,00						
<b>HST-HCR</b>								
Nośność charakterystyczna w betonie zarysowanym klasy C20/25	$N_{Rk,p}$ [kN]	5,0	9,0	12,0	25,0	3)	3)	
Nośność charakterystyczna w betonie zarysowanym klasy C50/60	$N_{Rk,p}$ [kN]	9,0	16,0	20,0	35,0	3)	3)	
Montażowy współczynnik bezpieczeństwa	$\gamma_{inst}$ [-]	1,00				3)	3)	

<sup>1)</sup> Wyłącznie kotwa HST i HST-R

<sup>2)</sup> W przypadku braku innych przepisów krajowych

<sup>3)</sup> Nie określono parametrów.

**Metalowa kotwa rozporowa Hilti HST, HST-R, HST-HCR, HST3, HST3-R**

**Charakterystyka produktu**

Wartości charakterystyczne nośności pod wpływem obciążeń rozciągających w betonie zarysowanym i niezarysowanym



**Tabela C1 ciąg dalszy**

			M8	M10	M12	M16	M20 <sup>1)</sup>	M24 <sup>1)</sup>
<b>Zniszczenie przez wyciągnięcie kotwy</b>								
<b>HST, HST-R oraz HST-HCR</b>								
Współczynnik zwiększający dla betonu niezarysowanego i zarysowanego	$\psi_c$	C20/25	1,00					
	$\psi_c$	C30/37	1,22					
	$\psi_c$	C40/50	1,41					
	$\psi_c$	C50/60	1,55					
<b>Zniszczenie przez wyłamanie stożka betonu i rozłupanie podłoża</b>								
<b>HST, HST-R oraz HST-HCR</b>								
Czynna głębokość osadzenia	$h_{ef}$	[mm]	47	60	70	82	101	125
Montażowy współczynnik bezpieczeństwa	$\gamma_{inst}$	[-]	1,20	1,00				
Współczynnik dla betonu zarysowanego	$k_{cr,N}$	[-]	7,7					
Współczynnik dla betonu niezarysowanego	$k_{ucr,N}$	[-]	11,0					
Nośność charakterystyczna w betonie niezarysowanym klasy C20/C25	$N_{Rk,sp}^0$	[kN]	9,0	16,0	20,0	35,0	50,0	60,0
Rozstaw kotew	$s_{cr,N}$ $s_{cr,sp}$	[mm]	3 $h_{ef}$					
Odległość od krawędzi podłoża	$c_{cr,N}$ $c_{cr,sp}$	[mm]	1,5 $h_{ef}$					

<sup>1)</sup> Wyłącznie kotwa HST i HST-R

<sup>2)</sup> W przypadku braku innych przepisów krajowych.

<sup>3)</sup> Nie określono parametrów.

**Metalowa kotwa rozporowa Hilti HST, HST-R, HST-HCR, HST3, HST3-R**

**Charakterystyka produktu**

Wartości charakterystyczne nośności pod wpływem obciążeń rozciągających w betonie zarysowanym i niezarysowanym



**Tabela C2: Nośność charakterystyczna na rozciąganie dla metalowej kotwy rozporowej Hilti HST3 oraz HST3-R w betonie zarysowanym i niezarysowanym**

			M8	M10	M12	M16	M20	M24
<b>Zniszczenie stali</b>								
<b>HST3</b>								
Nośność charakterystyczna	$N_{Rk,s}$	[kN]	19,7	32,5	45,1	76,0	124,2	127,0
Częściowy współczynnik bezpieczeństwa	$\gamma_{Ms}$ <sup>1)</sup>	[-]	1,40					1,41
<b>HST3-R</b>								
Nośność charakterystyczna	$N_{Rk,s}$	[kN]	17,7	28,7	42,5	69,4	115,8	156,0
Częściowy współczynnik bezpieczeństwa	$\gamma_{Ms}$ <sup>1)</sup>	[-]	1,40					1,56
<b>Zniszczenie przez wyciągnięcie kotwy</b>								
<b>HST3</b>								
Czynna głębokość osadzenia	$h_{ef,2}$	[mm]	47	60	70	85	101	125
Nośność charakterystyczna w betonie zarysowanym C20/25	$N_{Rk,p}$	[kN]	8,0	15,0	20,0	27,0	35,0	40,0
Nośność charakterystyczna w betonie niezarysowanym C20/25	$N_{Rk,p}$	[kN]	12,0	22,0	25,0	38,6	49,9	60,0
Montażowy współczynnik bezpieczeństwa	$\gamma_{inst}$	[-]	1,00					
<b>HST3-R</b>								
Czynna głębokość osadzenia	$h_{ef,2}$	[mm]	47	60	70	85	101	125
Nośność charakterystyczna w betonie zarysowanym C20/25	$N_{Rk,p}$	[kN]	8,5	15,0	20,0	27,0	35,0	40,0
Nośność charakterystyczna w betonie niezarysowanym C20/25	$N_{Rk,p}$	[kN]	12,0	22,0	25,0	38,6	49,9	60,0
Montażowy współczynnik bezpieczeństwa	$\gamma_{inst}$	[-]	1,00					
<b>HST3 oraz HST3-R</b>								
Czynna głębokość osadzenia	$h_{ef,1}$	[mm]	2)	40	50	65	2)	2)
Nośność charakterystyczna w betonie zarysowanym C20/25	$N_{Rk,p}$	[kN]	2)	8,7	12,2	18,0	2)	2)
Nośność charakterystyczna w betonie niezarysowanym C20/25	$N_{Rk,p}$	[kN]	2)	12,4	17,4	25,8	2)	2)
Montażowy współczynnik bezpieczeństwa	$\gamma_{inst}$	[-]	1,00					

1) W przypadku braku innych przepisów krajowych

2) Nie określono parametrów.

**Metalowa kotwa rozporowa Hilti HST, HST-R, HST-HCR, HST3, HST3-R****Charakterystyka produktu**

Wartości charakterystyczne nośności pod wpływem obciążeń rozciągających w betonie zarysowanym i niezarysowanym



**Tabela C2 ciąg dalszy**

		M8	M10	M12	M16	M20	M24
<b>Zniszczenie przez wyciągnięcie kotwy</b>							
<b>HST3 oraz HST3-R</b>							
Współczynnik zwiększający dla betonu zarysowanego i niezarysowanego	$\psi_c$ C20/25	1,00					
	$\psi_c$ C30/37	1,22					
	$\psi_c$ C40/50	1,41					
	$\psi_c$ C50/60	1,55					
<b>Zniszczenie przez wyłamanie stożka betonu i rozłupanie podłoża</b>							
<b>HST3 oraz HST3-R</b>							
Czynna głębokość osadzenia	$h_{ef,2}$ [mm]	47	60	70	85	101	125
Montażowy współczynnik bezpieczeństwa	$\gamma_{inst}$ [-]	1,00					
Współczynnik dla betonu zarysowanego	$k_{cr,N}$ [-]	7,7					
Współczynnik dla betonu niezarysowanego	$k_{ucr,N}$ [-]	11,0					
Nośność charakterystyczna w betonie niezarysowanym C20/25	$N_{Rk,sp}^0$ [kN]	12,0	22,0	25,0	38,6	49,9	60,0
Rozstaw kotew	$s_{cr,N}$ [mm]	3 $h_{ef}$					
Odległość od krawędzi podłoża	$c_{cr,N}$ [mm]	1,5 $h_{ef}$					
Rozstaw kotew	$s_{cr,sp}$ [mm]	3 $h_{ef}$				3,8 $h_{ef}$	3 $h_{ef}$
Odległość od krawędzi podłoża	$c_{cr,sp}$ [mm]	1,5 $h_{ef}$				1,9 $h_{ef}$	1,5 $h_{ef}$
<b>HST3 oraz HST3-R</b>							
Czynna głębokość osadzenia	$h_{ef,1}$ [mm]	2)	40	50	65	2)	2)
Montażowy współczynnik bezpieczeństwa	$\gamma_{inst}$ [-]	2)	1,00			2)	2)
Współczynnik dla betonu zarysowanego	$k_{cr,N}$ [-]	2)	7,7			2)	2)
Współczynnik dla betonu niezarysowanego	$k_{ucr,N}$ [-]	2)	11,0			2)	2)
Nośność charakterystyczna w betonie niezarysowanym C20/25	$N_{Rk,sp}^0$ [kN]	2)	12,4	17,4	25,8	2)	2)
Rozstaw kotew	$s_{cr,N}$ [mm]	2)	3 $h_{ef}$			2)	2)
Odległość od krawędzi podłoża	$c_{cr,N}$ [mm]	2)	1,5 $h_{ef}$			2)	2)
Rozstaw kotew	$s_{cr,sp}$ [mm]	2)	4,2 $h_{ef}$	3,6 $h_{ef}$	3,2 $h_{ef}$	2)	2)
Odległość od krawędzi podłoża	$c_{cr,sp}$ [mm]	2)	2,1 $h_{ef}$	1,8 $h_{ef}$	1,6 $h_{ef}$	2)	2)

1) W przypadku braku innych przepisów krajowych.

2) Nie określono parametrów.

**Metalowa kotwa rozporowa Hilti HST, HST-R, HST-HCR, HST3, HST3-R**

**Charakterystyka produktu**

Wartości charakterystyczne nośności pod wpływem obciążeń rozciągających w betonie zarysowanym i niezarysowanym





**Tabela C3: Nośność charakterystyczna na ścinanie dla metalowej kotwy rozporowej Hilti HST, HST-R oraz HST-HCR w betonie zarysowanym i niezarysowanym**

		M8	M10	M12	M16	M20 <sup>1)</sup>	M24 <sup>1)</sup>	
<b>Zniszczenie stali, siła ścinająca bez oddziaływania momentu zginającego</b>								
<b>HST</b>								
Nośność charakterystyczna	$V_{RK,s}^0$ [kN]	14,0	23,5	35,0	55,0	84,0	94,0	
Częściowy współczynnik bezpieczeństwa	$\gamma_{Ms}^{2)}$ [-]	1,25					1,50	
Współczynnik plastyczności	$k_7$ [-]	1,00						
<b>HST-R</b>								
Nośność charakterystyczna	$V_{RK,s}^0$ [kN]	13,0	20,0	30,0	50,0	80,0	115,0	
Częściowy współczynnik bezpieczeństwa	$\gamma_{Ms}^{2)}$ [-]	1,25			1,30	1,44		
Współczynnik plastyczności	$k_7$ [-]	1,00						
<b>HST-HCR</b>								
Nośność charakterystyczna	$V_{RK,s}^0$ [kN]	13,0	20,0	30,0	55,0	3)	3)	
Częściowy współczynnik bezpieczeństwa	$\gamma_{Ms}^{2)}$ [-]	1,25				3)	3)	
Współczynnik plastyczności	$k_7$ [-]	1,00				3)	3)	
<b>Zniszczenie stali, siła ścinająca z oddziaływaniem momentu zginającego</b>								
<b>HST</b>								
Nośność charakterystyczna	$M_{RK,s}^0$ [Nm]	30	60	105	240	454	595	
Częściowy współczynnik bezpieczeństwa	$\gamma_{Ms}^{2)}$ [-]	1,25					1,50	
<b>HST-R</b>								
Nośność charakterystyczna	$M_{RK,s}^0$ [Nm]	27	53	92	216	422	730	
Częściowy współczynnik bezpieczeństwa	$\gamma_{Ms}^{2)}$ [-]	1,25			1,30	1,44		
<b>HST-HCR</b>								
Nośność charakterystyczna	$M_{RK,s}^0$ [Nm]	30	60	105	266	3)	3)	
Częściowy współczynnik bezpieczeństwa	$\gamma_{Ms}^{2)}$ [-]	1,25				3)	3)	

1) Wyłącznie kotwa HST i HST-R.

2) W przypadku braku innych przepisów krajowych.

3) Nie określono parametrów.

**Metalowa kotwa rozporowa Hilti HST, HST-R, HST-HCR, HST3, HST3-R****Charakterystyka produktu**

Wartości charakterystyczne nośności pod wpływem obciążeń ścinających w betonie zarysowanym i niezarysowanym



**Tabela C3 ciąg dalszy**

	M8	M10	M12	M16	M20 <sup>1)</sup>	M24 <sup>1)</sup>
<b>Zniszczenie przez wyłupanie betonu</b>						
<b>HST, HST-R oraz HST-HCR</b>						
Montażowy współczynnik bezpieczeństwa $\gamma_{inst}$ [-]	1,00					
Współczynnik dla wyłupania betonu $k_8$ [-]	2,0	2,0	2,2	2,5	2,5	2,5
<b>Zniszczenie krawędzi podłoża betonowego</b>						
<b>HST, HST-R oraz HST-HCR</b>						
Czynna długość kotwy poddanej obciążeniu ścinającemu $l_f$ [mm]	47	60	70	82	101	125
Średnica kotwy $d_{nom}$ [mm]	8	10	12	16	20	24
Montażowy współczynnik bezpieczeństwa $\gamma_{inst}$ [-]	1,00					

<sup>1)</sup> Wyłącznie kotwa HST i HST-R.

<sup>2)</sup> W przypadku braku innych przepisów krajowych.

<sup>3)</sup> Nie określono parametrów.

**Metalowa kotwa rozporowa Hilti HST, HST-R, HST-HCR, HST3, HST3-R**

**Charakterystyka produktu**

Wartości charakterystyczne nośności pod wpływem obciążeń ścinających w betonie zarysowanym i niezarysowanym



**Tabela C4: Nośność charakterystyczna na ścinanie dla metalowej kotwy rozporowej Hilti HST3 oraz HST3-R w betonie zarysowanym i niezarysowanym**

		M8	M10	M12	M16	M20	M24	
<b>Zniszczenie stali, siła ścinająca bez oddziaływania momentu zginającego</b>								
<b>HST3</b>								
Czynna głębokość osadzenia	$h_{ef,2}$ [mm]	47	60	70	85	101	125	
Nośność charakterystyczna	$V_{RK,s}^0$ [kN]	13,8	23,6	35,4	55,3	83,9	94,0	
Nośność charakterystyczna przy zastosowaniu zestawu do wypełniania	$V_{RK,s}^0$ [kN]	16,6	25,8	39,0	60,9	100,4	2)	
Częściowy współczynnik bezpieczeństwa $\gamma_{Ms}^{1)}$	[-]	1,25					1,50	
Współczynnik plastyczności	$k_2$ [-]	1,00						
<b>HST3-R</b>								
Czynna głębokość osadzenia	$h_{ef,2}$ [mm]	47	60	70	85	101	125	
Nośność charakterystyczna	$V_{RK,s}^0$ [kN]	15,7	25,3	36,7	63,6	97,2	115,0	
Nośność charakterystyczna przy zastosowaniu zestawu do wypełniania	$V_{RK,s}^0$ [kN]	19,5	28,4	44,3	70,2	102,7	2)	
Częściowy współczynnik bezpieczeństwa $\gamma_{Ms}^{1)}$	[-]	1,25					1,30	
Współczynnik plastyczności	$k_7$ [-]	1,00						
<b>HST3</b>								
Czynna głębokość osadzenia	$h_{ef,1}$ [mm]	2)	40	50	65	2)	2)	
Nośność charakterystyczna	$V_{RK,s}^0$ [kN]	2)	21,9	34,0	54,5	2)	2)	
Częściowy współczynnik bezpieczeństwa $\gamma_{Ms}^{1)}$	[-]	2)	1,25			2)	2)	
Współczynnik plastyczności	$k_7$ [-]	2)	1,00			2)	2)	
<b>HST3-R</b>								
Czynna głębokość osadzenia	$h_{ef,1}$ [mm]	2)	40	50	65	2)	2)	
Nośność charakterystyczna	$V_{RK,s}^0$ [kN]	2)	25,6	31,1	48,6	2)	2)	
Częściowy współczynnik bezpieczeństwa $\gamma_{Ms}^{1)}$	[-]	2)	1,25			2)	2)	
Współczynnik plastyczności	$k_7$ [-]	2)	1,00			2)	2)	

1) W przypadku braku innych przepisów krajowych.

2) Nie określono parametrów.

**Metalowa kotwa rozporowa Hilti HST, HST-R, HST-HCR, HST3, HST3-R****Charakterystyka produktu**

Wartości charakterystyczne nośności pod wpływem obciążeń ścinających w betonie zarysowanym i niezarysowanym



**Tabela C4 ciąg dalszy**

<b>Zniszczenie stali, siła ścinająca z oddziaływaniem momentu zginającego</b>							
<b>HST3</b>							
Charakterystyczny moment zginający	$M_{Rk,s}^0$ [Nm]	30	60	105	240	457	595
Częściowy współczynnik bezpieczeństwa	$\gamma_{Ms}^{1)}$ [-]	1,25					1,50
<b>HST3-R</b>							
Charakterystyczny moment zginający	$M_{Rk,s}^0$ [Nm]	27	53	93	216	425	730
Częściowy współczynnik bezpieczeństwa	$\gamma_{Ms}^{1)}$ [-]	1,25					1,30
<b>Zniszczenie przez wyłupanie betonu</b>							
<b>HST3 oraz HST3-R</b>							
Czynna głębokość osadzenia	$h_{ef,2}$ [mm]	47	60	70	85	101	125
Montażowy współczynnik bezpieczeństwa	$\gamma_{inst}$ [-]	1,00					
Współczynnik dla wyłupania betonu	$k_8$ [-]	2,62	2,67	2,78	3,41	3,20	2,50
Częściowy współczynnik bezpieczeństwa	$\gamma_2 = \gamma_{inst}$ [-]						
<b>HST3 oraz HST3-R</b>							
Czynna głębokość osadzenia	$h_{ef,1}$ [mm]	<sup>2)</sup>	40	50	65	<sup>2)</sup>	<sup>2)</sup>
Montażowy współczynnik bezpieczeństwa	$\gamma_{inst}$ [-]	1,00					
Współczynnik dla wyłupania betonu	$k_8$ [-]	<sup>2)</sup>	2,67	2,78	3,41	<sup>2)</sup>	<sup>2)</sup>
<b>Zniszczenie krawędzi podłoża betonowego</b>							
<b>HST3 oraz HST3-R</b>							
Czynna długość kotwy poddanej obciążeniu ścinającemu	$l_{f,2}$ [mm]	47	60	70	85	101	125
Czynna długość kotwy poddanej obciążeniu ścinającemu przy zmniejszonej głębokości osadzania	$l_{f,1}$ [mm]	<sup>2)</sup>	40	50	65	<sup>2)</sup>	<sup>2)</sup>
Średnica kotwy	$d_{nom}$ [mm]	8	10	12	16	20	24
Montażowy współczynnik bezpieczeństwa	$\gamma_{inst}$ [-]	1,00					

<sup>1)</sup> W przypadku braku innych przepisów krajowych.

<sup>2)</sup> Nie określono parametrów.

**Metalowa kotwa rozporowa Hilti HST, HST-R, HST-HCR, HST3, HST3-R**

**Charakterystyka produktu**

Wartości charakterystyczne nośności pod wpływem obciążeń ścinających w betonie zarysowanym i niezarysowanym





**Tabela C5: Przemieszczenia pod wpływem statycznych i quasi-statycznych obciążeń rozciągających i ścinających dla metalowych kotew rozporowych Hilti HST, HST-R oraz HST-HCR**

			M8	M10	M12	M16	M20 <sup>1)</sup>	M24 <sup>1)</sup>
<b>Przemieszczenia pod wpływem obciążeń rozciągających</b>								
<b>HST</b>								
Obciążenia rozciągające w betonie zarysowanym	N	[kN]	2,0	4,3	5,7	9,5	14,3	19,0
Odpowiednie przemieszczenie	$\delta_{NO}$	[mm]	1,3	0,2	0,1	0,5	1,9	2,2
	$\delta_{N\infty}$	[mm]	1,2	1,0	1,2	1,2	2,3	2,5
Obciążenia rozciągające w betonie niezarysowanym	N	[kN]	3,6	7,6	9,5	16,7	23,8	28,6
Odpowiednie przemieszczenie	$\delta_{NO}$	[mm]	0,2	0,1	0,1	0,4	0,6	0,5
	$\delta_{N\infty}$	[mm]	1,1	1,1	1,1	1,1	1,4	1,4
<b>HST-R oraz HST-HCR</b>								
Obciążenia rozciągające w betonie zarysowanym	N	[kN]	2,4	4,3	5,7	11,9	14,3	19,0
Odpowiednie przemieszczenie	$\delta_{NO}$	[mm]	0,6	0,2	0,8	1,0	1,1	0,8
	$\delta_{N\infty}$	[mm]	1,5	1,2	1,4	1,2	1,2	1,7
Obciążenia rozciągające w betonie niezarysowanym	N	[kN]	4,3	7,6	9,5	16,7	23,8	28,6
Odpowiednie przemieszczenie	$\delta_{NO}$	[mm]	0,1	0,1	0,1	0,1	0,5	0,8
	$\delta_{N\infty}$	[mm]	1,5	1,2	1,4	1,2	1,2	1,7
<b>Przemieszczenia pod wpływem obciążeń ścinających</b>								
<b>HST</b>								
Obciążenie ścinające w betonie zarysowanym i niezarysowanym	V	[kN]	8,0	13,4	20,0	31,4	48,0	45,0
Odpowiednie przemieszczenie	$\delta_{VO}$	[mm]	2,5	2,5	3,7	4,0	2,7	2,0
	$\delta_{V\infty}$	[mm]	3,8	3,7	5,5	6,0	4,1	3,0
<b>HST-R oraz HST-HCR</b>								
Obciążenie ścinające w betonie zarysowanym i niezarysowanym	V	[kN]	7,4	11,0	17,0	27,5	40,0	57,0
Odpowiednie przemieszczenie	$\delta_{VO}$	[mm]	1,6	3,3	4,9	2,2	2,5	2,5
	$\delta_{V\infty}$	[mm]	2,4	4,9	7,4	3,3	3,7	3,7

<sup>1)</sup> Wyłącznie kotwa HST i HST-R

**Metalowa kotwa rozporowa Hilti HST, HST-R, HST-HCR, HST3, HST3-R**

**Charakterystyka produktu**  
 Przemieszczenia pod wpływem obciążeń rozciągających i ścinających



**Tabela C6: Przemieszczenia pod wpływem statycznych i quasi-statycznych obciążeń rozciągających i ścinających dla metalowych kotew rozporowych Hilti HST3 oraz HST3-R**

			M8	M10	M12	M16	M20	M24
<b>Przemieszczenia pod wpływem obciążeń rozciągających</b>								
<b>HST3</b>								
Czynna głębokość osadzenia	$h_{ef,2}$	[mm]	47	60	70	85	101	125
Obciążenia rozciągające w betonie zarysowanym	N	[kN]	3,6	5,7	9,5	13,4	17,4	19,0
Odpowiednie przemieszczenie	$\delta_{N0}$	[mm]	0,6	0,6	0,8	1,8	1,3	2,2
	$\delta_{N\infty}$	[mm]	1,1	1,3	1,6	1,7	1,8	2,5
Obciążenia rozciągające w betonie niezarysowanym	N	[kN]	5,7	9,5	11,9	18,9	24,4	28,6
Odpowiednie przemieszczenie	$\delta_{N0}$	[mm]	0,2	0,3	0,2	0,8	0,5	0,5
	$\delta_{N\infty}$	[mm]	0,4	0,5	0,4	1,5	0,9	1,4
<b>HST3-R</b>								
Czynna głębokość osadzenia	$h_{ef,2}$	[mm]	47	60	70	85	101	125
Obciążenia rozciągające w betonie zarysowanym	N	[kN]	3,6	5,7	9,5	13,4	17,4	19,0
Odpowiednie przemieszczenie	$\delta_{N0}$	[mm]	0,6	0,6	0,8	1,8	1,3	0,8
	$\delta_{N\infty}$	[mm]	1,1	1,3	1,6	1,7	1,8	1,7
Obciążenia rozciągające w betonie niezarysowanym	N	[kN]	5,7	9,5	11,9	18,9	24,4	28,6
Odpowiednie przemieszczenie	$\delta_{N0}$	[mm]	0,2	0,3	0,2	0,8	0,5	0,8
	$\delta_{N\infty}$	[mm]	0,4	0,5	0,4	1,5	0,9	1,7
<b>HST3 oraz HST3-R</b>								
Czynna głębokość osadzenia	$h_{ef,1}$	[mm]	<sup>1)</sup>	40	50	65	<sup>1)</sup>	<sup>1)</sup>
Obciążenia rozciągające w betonie zarysowanym	N	[kN]	<sup>1)</sup>	4,3	6,1	9,0	<sup>1)</sup>	<sup>1)</sup>
Odpowiednie przemieszczenie	$\delta_{N0}$	[mm]	<sup>1)</sup>	0,6	0,4	0,6	<sup>1)</sup>	<sup>1)</sup>
	$\delta_{N\infty}$	[mm]	<sup>1)</sup>	1,3	1,6	1,7	<sup>1)</sup>	<sup>1)</sup>
Obciążenia rozciągające w betonie niezarysowanym	N	[kN]	<sup>1)</sup>	6,1	8,5	12,6	<sup>1)</sup>	<sup>1)</sup>
Odpowiednie przemieszczenie	$\delta_{N0}$	[mm]	<sup>1)</sup>	0,2	0,7	0,8	<sup>1)</sup>	<sup>1)</sup>
	$\delta_{N\infty}$	[mm]	<sup>1)</sup>	0,4	1,2	1,5	<sup>1)</sup>	<sup>1)</sup>

<sup>1)</sup> Nie określono parametrów.

**Metalowa kotwa rozporowa Hilti HST, HST-R, HST-HCR, HST3, HST3-R**

**Charakterystyka produktu**  
 Przemieszczenia pod wpływem obciążeń rozciągających i ścinających



**Załącznik C10**

**Tabela C6 ciąg dalszy**

			M8	M10	M12	M16	M20	M24
<b>Przemieszczenia pod wpływem obciążeń ścinających</b>								
<b>HST3</b>								
Czynna głębokość osadzenia	$h_{ef,2}$	[mm]	47	60	70	85	101	125
Obciążenia ścinające w betonie zarysowanym i niezarysowanym	V	[kN]	7,9	13,5	20,2	31,6	47,9	45,0
Odpowiednie przemieszczenie	$\delta_{V0}$	[mm]	2,8	2,5	3,8	4,3	2,7	2,0
	$\delta_{V\infty}$	[mm]	4,2	3,7	5,6	6,4	4,1	3,0
Obciążenie ścinające w betonie zarysowanym i niezarysowanym przy zastosowaniu zestawu do wypełniania	V	[kN]	9,5	14,7	22,3	34,8	57,4	1)
Odpowiednie przemieszczenie	$\delta_{V0}$	[mm]	2,9	2,3	2,0	2,3	5,9	1)
	$\delta_{V\infty}$	[mm]	4,4	3,4	3,0	3,5	8,8	1)
<b>HST3-R</b>								
Czynna głębokość osadzenia	$h_{ef,2}$	[mm]	47	60	70	85	101	125
Obciążenia ścinające w betonie zarysowanym i niezarysowanym	V	[kN]	8,9	14,5	21,0	36,3	55,6	57,0
Odpowiednie przemieszczenie	$\delta_{V0}$	[mm]	7,1	2,3	3,3	5,7	3,2	2,5
	$\delta_{V\infty}$	[mm]	10,7	3,4	4,9	8,5	4,8	3,7
Obciążenie ścinające w betonie zarysowanym i niezarysowanym przy zastosowaniu zestawu do wypełniania	V	[kN]	11,1	16,2	25,3	40,1	58,7	1)
Odpowiednie przemieszczenie	$\delta_{V0}$	[mm]	1,9	2,0	2,3	3,4	4,9	1)
	$\delta_{V\infty}$	[mm]	2,9	3,0	3,4	5,0	7,3	1)

1) Nie określono parametrów.

**Metalowa kotwa rozporowa Hilti HST, HST-R, HST-HCR, HST3, HST3-R**

**Charakterystyka produktu**  
 Przemieszczenia pod wpływem obciążeń rozciągających i ścinających



**Tabela C6 ciąg dalszy**

<b>HST3</b>								
Czynna głębokość osadzenia	$h_{ef,1}$	[mm]	<sup>1)</sup>	40	50	65	<sup>1)</sup>	<sup>1)</sup>
Obciążenia ścinające w betonie zarysowanym i niezarysowanym	V	[kN]	<sup>1)</sup>	12,5	19,4	31,1	<sup>1)</sup>	<sup>1)</sup>
Odpowiednie przemieszczenie	$\delta_{v0}$	[mm]	<sup>1)</sup>	4,2	3,1	4,4	<sup>1)</sup>	<sup>1)</sup>
	$\delta_{v\infty}$	[mm]	<sup>1)</sup>	6,3	4,7	6,6	<sup>1)</sup>	<sup>1)</sup>
<b>HST3-R</b>								
Czynna głębokość osadzenia	$h_{ef,1}$	[mm]	<sup>1)</sup>	40	50	65	<sup>1)</sup>	<sup>1)</sup>
Obciążenia ścinające w betonie zarysowanym i niezarysowanym	V	[kN]	<sup>1)</sup>	14,6	17,8	27,8	<sup>1)</sup>	<sup>1)</sup>
Odpowiednie przemieszczenie	$\delta_{v0}$	[mm]	<sup>1)</sup>	3,7	3,9	3,5	<sup>1)</sup>	<sup>1)</sup>
	$\delta_{v\infty}$	[mm]	<sup>1)</sup>	5,6	5,8	5,3	<sup>1)</sup>	<sup>1)</sup>

<sup>1)</sup> Nie określono parametrów.

**Metalowa kotwa rozporowa Hilti HST, HST-R, HST-HCR, HST3, HST3-R**

**Charakterystyka produktu**  
 Przemieszczenia pod wpływem obciążeń rozciągających i ścinających





**Tabela C7: Nośność charakterystyczna na rozciąganie dla obciążeń sejsmicznych dla metalowej kotwy rozporowej Hilti HST oraz HST-R, kategoria właściwości C1**

		M8	M10	M12	M16	M20	M24
<b>Zniszczenie stali</b>							
<b>HST</b>							
Nośność charakterystyczna	$N_{Rk,s,C1}$ [kN]	<sup>3)</sup>	32,0	45,0	76,0	<sup>3)</sup>	<sup>3)</sup>
Częściowy współczynnik bezpieczeństwa	$\gamma_{Ms,C1}$ <sup>1)</sup> [-]	<sup>3)</sup>	1,50			<sup>3)</sup>	<sup>3)</sup>
<b>HST-R</b>							
Nośność charakterystyczna	$N_{Rk,s,C1}$ [kN]	<sup>3)</sup>	28,0	40,0	69,0	<sup>3)</sup>	<sup>3)</sup>
Częściowy współczynnik bezpieczeństwa	$\gamma_{Ms,C1}$ <sup>1)</sup> [-]	<sup>3)</sup>	1,50	1,56	<sup>3)</sup>	<sup>3)</sup>	
<b>Zniszczenie przez wyciągnięcie kotwy</b>							
<b>HST oraz HST-R</b>							
Nośność charakterystyczna	$N_{Rk,p,C1}$ [kN]	<sup>3)</sup>	8,0	10,7	18,0	<sup>3)</sup>	<sup>3)</sup>
Montażowy współczynnik bezpieczeństwa	$\gamma_{inst}$ [-]	<sup>3)</sup>	1,00			<sup>3)</sup>	<sup>3)</sup>
<b>Zniszczenie przez wyłamanie stożka betonu <sup>2)</sup></b>							
<b>HST oraz HST-R</b>							
Montażowy współczynnik bezpieczeństwa	$\gamma_{inst}$ [-]	<sup>3)</sup>	1,00			<sup>3)</sup>	<sup>3)</sup>
<b>Zniszczenie przez rozłupanie podłoża <sup>2)</sup></b>							
<b>HST oraz HST-R</b>							
Montażowy współczynnik bezpieczeństwa	$\gamma_{inst}$ [-]	<sup>3)</sup>	1,00			<sup>3)</sup>	<sup>3)</sup>

<sup>1)</sup> W przypadku braku innych przepisów krajowych.

<sup>2)</sup> Dla zniszczenia przez wyłamanie stożka betonu oraz rozłupanie podłoża patrz→ norma EN 1992-4:2018.

<sup>3)</sup> Nie określono parametrów.

**Metalowa kotwa rozporowa Hilti HST, HST-R, HST-HCR, HST3, HST3-R**

**Charakterystyka produktu**  
 Nośność charakterystyczna na rozciąganie dla kategorii właściwości C1



**Tabela C8: Nośność charakterystyczna na rozciąganie dla obciążeń sejsmicznych dla metalowej kotwy rozporowej Hilti HST3 oraz HST3-R, kategoria właściwości C1**

			M8	M10	M12	M16	M20	M24
<b>Zniszczenie stali</b>								
<b>HST3</b>								
Czynna głębokość osadzenia	$h_{ef,2}$	[mm]	47	60	70	85	101	<sup>3)</sup>
Nośność charakterystyczna	$N_{Rk,s,C1}$	[kN]	19,7	32,5	45,1	76,0	124,2	<sup>3)</sup>
Częściowy współczynnik bezpieczeństwa	$\gamma_{Ms,C1}$ <sup>1)</sup>	[-]	1,40					<sup>3)</sup>
<b>HST3-R</b>								
Czynna głębokość osadzenia	$h_{ef,2}$	[mm]	47	60	70	85	101	<sup>3)</sup>
Nośność charakterystyczna	$N_{Rk,s,C1}$	[kN]	17,7	28,7	42,5	69,4	115,8	<sup>3)</sup>
Częściowy współczynnik bezpieczeństwa	$\gamma_{Ms,C1}$ <sup>1)</sup>	[-]	1,40					<sup>3)</sup>
<b>Zniszczenie przez wyciągnięcie kotwy</b>								
<b>HST3</b>								
Czynna głębokość osadzenia	$h_{ef,2}$	[mm]	47	60	70	85	101	<sup>3)</sup>
Nośność charakterystyczna	$N_{Rk,p,C1}$	[kN]	8,0	15,0	20,0	27,0	35,0	<sup>3)</sup>
Montażowy współczynnik bezpieczeństwa	$\gamma_{inst}$	[-]	1,00					<sup>3)</sup>
Czynna głębokość osadzenia	$h_{ef,1}$	[mm]	<sup>3)</sup>	<sup>3)</sup>	50	<sup>3)</sup>	<sup>3)</sup>	<sup>3)</sup>
Nośność charakterystyczna	$N_{Rk,p,C1}$	[kN]	<sup>3)</sup>	<sup>3)</sup>	12,2	<sup>3)</sup>	<sup>3)</sup>	<sup>3)</sup>
Montażowy współczynnik bezpieczeństwa	$\gamma_{inst}$	[-]	1,00					<sup>3)</sup>
<b>HST3-R</b>								
Czynna głębokość osadzenia	$h_{ef,2}$	[mm]	47	60	70	85	101	<sup>3)</sup>
Nośność charakterystyczna	$N_{Rk,p,C1}$	[kN]	8,5	15,0	20,0	27,0	35,0	<sup>3)</sup>
Montażowy współczynnik bezpieczeństwa	$\gamma_{inst}$	[-]	1,00					<sup>3)</sup>

<sup>1)</sup> W przypadku braku innych przepisów krajowych.

<sup>2)</sup> Dla zniszczenia przez wyłamane stożka betonu oraz rozłupanie podłoża patrz → norma EN 1992-4:2018.

<sup>3)</sup> Nie określono parametrów.

**Metalowa kotwa rozporowa Hilti HST, HST-R, HST-HCR, HST3, HST3-R**

**Charakterystyka produktu**  
 Nośność charakterystyczna na rozciąganie dla kategorii właściwości C1



**Tabela C8 ciąg dalszy**

	M8	M10	M12	M16	M20	M24
<b>Zniszczenie przez wyłamanie stożka betonu <sup>2)</sup></b>						
<b>HST3 oraz HST3-R</b>						
Czynna głębokość osadzenia $h_{ef,2}$ [mm]	47	60	70	85	101	<sup>3)</sup>
Montażowy współczynnik bezpieczeństwa $\gamma_{inst}$ [-]	1,00					<sup>3)</sup>
<b>Zniszczenie przez rozłupanie podłoża <sup>2)</sup></b>						
<b>HST3 oraz HST3-R</b>						
Czynna głębokość osadzenia $h_{ef,2}$ [mm]	47	60	70	85	101	<sup>3)</sup>
Montażowy współczynnik bezpieczeństwa $\gamma_{inst}$ [-]	1,00					<sup>3)</sup>

<sup>1)</sup> W przypadku braku innych przepisów krajowych.

<sup>2)</sup> Dla zniszczenia przez wyłamanie stożka betonu oraz rozłupanie podłoża patrz → norma EN 1992-4:2018.

<sup>3)</sup> Nie określono parametrów.

**Metalowa kotwa rozporowa Hilti HST, HST-R, HST-HCR, HST3, HST3-R**

**Charakterystyka produktu**  
 Nośność charakterystyczna na rozciąganie dla kategorii właściwości C1



**Tabela C9: Nośność charakterystyczna na ścinanie dla obciążeń sejsmicznych dla metalowej kotwy rozporowej Hilti HST oraz HST-R, kategoria właściwości C1**

		M8	M10	M12	M16	M20	M24
<b>Zniszczenie stali</b>							
<b>HST</b>							
Nośność charakterystyczna	$V_{Rk,s,C1}$ [kN]	<sup>3)</sup>	16,0	27,0	41,3	<sup>3)</sup>	<sup>3)</sup>
Częściowy współczynnik bezpieczeństwa	$\gamma_{Ms,C1}$ <sup>1)</sup> [-]	<sup>3)</sup>	1,25			<sup>3)</sup>	<sup>3)</sup>
<b>HST-R</b>							
Nośność charakterystyczna	$V_{Rk,s,C1}$ [kN]	<sup>3)</sup>	13,6	23,1	37,5	<sup>3)</sup>	<sup>3)</sup>
Częściowy współczynnik bezpieczeństwa	$\gamma_{Ms,C1}$ <sup>1)</sup> [-]	<sup>3)</sup>	1,25		1,30	<sup>3)</sup>	<sup>3)</sup>
<b>Zniszczenie przez wylupanie betonu <sup>2)</sup></b>							
<b>HST oraz HST-R</b>							
Montażowy współczynnik bezpieczeństwa	$\gamma_{inst}$ [-]	<sup>3)</sup>	1,00			<sup>3)</sup>	<sup>3)</sup>
<b>Zniszczenie krawędzi podłoża betonowego <sup>2)</sup></b>							
<b>HST oraz HST-R</b>							
Montażowy współczynnik bezpieczeństwa	$\gamma_{inst}$ [-]	<sup>3)</sup>	1,00			<sup>3)</sup>	<sup>3)</sup>

<sup>1)</sup> W przypadku braku innych przepisów krajowych.

<sup>2)</sup> Dla zniszczenia przez wylupanie betonu oraz zniszczenia krawędzi podłoża betonowego patrz → norma EN 1992-4:2018.

<sup>3)</sup> Nie określono parametrów.

**Metalowa kotwa rozporowa Hilti HST, HST-R, HST-HCR, HST3, HST3-R**

**Charakterystyka produktu**

Nośność charakterystyczna na ścinanie dla kategorii właściwości C1



**Tabela C10: Nośność charakterystyczna na ścinanie dla obciążeń sejsmicznych dla metalowej kotwy rozporowej Hilti HST3 oraz HST3-R, kategoria właściwości C1**

		M8	M10	M12	M16	M20	M24
<b>Zniszczenie stali</b>							
<b>HST3</b>							
Czynna głębokość osadzenia	$h_{ef,2}$ [mm]	47	60	70	85	101	3)
Nośność charakterystyczna	$V_{Rk,s,C1}$ [kN]	12,5	21,4	32,2	48,7	77,6	3)
Nośność charakterystyczna przy zastosowaniu zestawu do wypełniania	$V_{Rk,s,C1}$ [kN]	16,6	25,8	39,0	60,9	100,4	3)
Częściowy współczynnik bezpieczeństwa	$\gamma_{Ms,C1}^{1)}$ [-]	1,25					3)
Czynna głębokość osadzenia	$h_{ef,1}$ [mm]	3)	3)	50,0	3)	3)	3)
Nośność charakterystyczna	$V_{Rk,s,C1}$ [kN]	3)	3)	32,3	3)	3)	3)
Częściowy współczynnik bezpieczeństwa	$\gamma_{Ms,C1}^{1)}$ [-]	1,25					3)
<b>HST3-R</b>							
Czynna głębokość osadzenia	$h_{ef,2}$ [mm]	47	60	70	85	101	3)
Nośność charakterystyczna	$V_{Rk,s,C1}$ [kN]	15,0	22,8	36,6	60,4	56,7	3)
Nośność charakterystyczna przy zastosowaniu zestawu do wypełniania	$V_{Rk,s,C1}$ [kN]	19,5	28,4	44,3	70,2	102,7	3)
Częściowy współczynnik bezpieczeństwa	$\gamma_{Ms,C1}^{1)}$ [-]	1,25					3)
<b>Zniszczenie przez wylupanie betonu <sup>2)</sup></b>							
<b>HST3 oraz HST3-R</b>							
Czynna głębokość osadzenia	$h_{ef,2}$ [mm]	47	60	70	85	101	3)
Montażowy współczynnik bezpieczeństwa	$\gamma_{inst}$ [-]	1,00					3)
<b>Zniszczenie krawędzi podłoża betonowego <sup>2)</sup></b>							
<b>HST3 oraz HST3-R</b>							
Czynna głębokość osadzenia	$h_{ef,2}$ [mm]	47	60	70	85	101	3)
Montażowy współczynnik bezpieczeństwa	$\gamma_{inst}$ [-]	1,00					3)

<sup>1)</sup> W przypadku braku innych przepisów krajowych.

<sup>2)</sup> Dla zniszczenia przez wylupanie betonu oraz zniszczenia krawędzi podłoża betonowego patrz → norma EN 1992-4:2018.

<sup>3)</sup> Nie określono parametrów.

**Metalowa kotwa rozporowa Hilti HST, HST-R, HST-HCR, HST3, HST3-R**

**Charakterystyka produktu**

Nośność charakterystyczna na ścinanie dla kategorii właściwości C1





**Tabela C11: Nośność charakterystyczna na rozciąganie dla obciążeń sejsmicznych dla metalowej kotwy rozporowej Hilti HST oraz HST-R, kategoria właściwości C2**

		M8	M10	M12	M16	M20	M24
<b>Zniszczenie stali</b>							
<b>HST</b>							
Nośność charakterystyczna	$N_{Rk,s,C2}$ [kN]	<sup>3)</sup>	32,0	45,0	76,0	<sup>3)</sup>	<sup>3)</sup>
Częściowy współczynnik bezpieczeństwa	$\gamma_{Ms,C2}$ <sup>1)</sup> [-]	<sup>3)</sup>	1,50			<sup>3)</sup>	<sup>3)</sup>
<b>HST-R</b>							
Nośność charakterystyczna	$N_{Rk,s,C2}$ [kN]	<sup>3)</sup>	28,0	40,0	69,0	<sup>3)</sup>	<sup>3)</sup>
Częściowy współczynnik bezpieczeństwa	$\gamma_{Ms,C2}$ <sup>1)</sup> [-]	<sup>3)</sup>	1,50		1,56	<sup>3)</sup>	<sup>3)</sup>
<b>Zniszczenie przez wyciągnięcie kotwy</b>							
<b>HST oraz HST-R</b>							
Nośność charakterystyczna	$N_{Rk,p,C2}$ [kN]	<sup>3)</sup>	3,3	10,0	12,8	<sup>3)</sup>	<sup>3)</sup>
Montażowy współczynnik bezpieczeństwa	$\gamma_{inst}$ [-]	<sup>3)</sup>	1,00			<sup>3)</sup>	<sup>3)</sup>
<b>Zniszczenie przez wyłamanie stożka betonu <sup>2)</sup></b>							
<b>HST oraz HST-R</b>							
Montażowy współczynnik bezpieczeństwa	$\gamma_{inst}$ [-]	<sup>3)</sup>	1,00			<sup>3)</sup>	<sup>3)</sup>
<b>Zniszczenie przez rozłupanie podłoża <sup>2)</sup></b>							
<b>HST oraz HST-R</b>							
Montażowy współczynnik bezpieczeństwa	$\gamma_{inst}$ [-]	<sup>3)</sup>	1,00			<sup>3)</sup>	<sup>3)</sup>

<sup>1)</sup> W przypadku braku innych przepisów krajowych.

<sup>2)</sup> Dla zniszczenia przez wyłamanie stożka betonu oraz rozłupanie podłoża, patrz → norma EN 1992-4:2018.

<sup>3)</sup> Nie określono parametrów.

**Tabela C12: Przemieszczenia pod wpływem sejsmicznych obciążeń rozciągających dla metalowych kotew rozporowych Hilti HST oraz HST-R, kategoria właściwości C2**

		M8	M10	M12	M16	M20	M24
<b>HST oraz HST-R</b>							
Przemieszczenie SGU	$\delta_{N,C2(SGU)}$ [mm]	<sup>1)</sup>	1,4	6,7	4,0	<sup>1)</sup>	<sup>1)</sup>
Przemieszczenie SGN	$\delta_{N,C2(SGN)}$ [mm]	<sup>1)</sup>	8,6	15,9	13,3	<sup>1)</sup>	<sup>1)</sup>

<sup>1)</sup> Nie określono parametrów.

**Metalowa kotwa rozporowa Hilti HST, HST-R, HST-HCR, HST3, HST3-R**

**Charakterystyka produktu**

Nośność charakterystyczna na rozciąganie oraz przemieszczenia pod wpływem obciążeń rozciągających dla kategorii właściwości C2



**Tabela C13: Nośność charakterystyczna na rozciąganie dla obciążeń sejsmicznych dla metalowej kotwy rozporowej Hilti HST3 oraz HST3-R, kategoria właściwości C2**

		M8	M10	M12	M16	M20	M24
<b>Zniszczenie stali</b>							
<b>HST3</b>							
Czynna głębokość osadzenia	$h_{ef,2}$ [mm]	47	60	70	85	101	3)
Czynna głębokość osadzenia	$h_{ef,1}$ [mm]	3)	3)	50	3)	3)	3)
Nośność charakterystyczna	$N_{Rk,s,C2}$ [kN]	19,7	32,5	45,1	76,0	124,2	3)
Częściowy współczynnik bezpieczeństwa	$\gamma_{Ms,C2}^{1)}$ [-]	1,40					3)
<b>HST3-R</b>							
Czynna głębokość osadzenia	$h_{ef,2}$ [mm]	47	60	70	85	101	3)
Nośność charakterystyczna	$N_{Rk,s,C2}$ [kN]	17,7	28,7	42,5	69,4	115,8	3)
Częściowy współczynnik bezpieczeństwa	$\gamma_{Ms,C2}^{1)}$ [-]	1,40					3)
<b>Zniszczenie przez wyciągnięcie kotwy</b>							
<b>HST3</b>							
Czynna głębokość osadzenia	$h_{ef,2}$ [mm]	47	60	70	85	101	3)
Nośność charakterystyczna	$N_{Rk,p,C2}$ [kN]	3,0	10,4	19,5	27,0	35,0	3)
Montażowy współczynnik bezpieczeństwa	$\gamma_{inst}$ [-]	1,00					3)
Czynna głębokość osadzenia	$h_{ef,1}$ [mm]	3)	3)	50	3)	3)	3)
Nośność charakterystyczna	$N_{Rk,p,C2}$ [kN]	3)	3)	11,4	3)	3)	3)
Montażowy współczynnik bezpieczeństwa	$\gamma_{inst}$ [-]	1,00					3)
<b>HST3-R</b>							
Czynna głębokość osadzenia	$h_{ef,2}$ [mm]	47	60	70	85	101	3)
Nośność charakterystyczna	$N_{Rk,p,C2}$ [kN]	3,4	10,4	19,5	27,0	35,0	3)
Montażowy współczynnik bezpieczeństwa	$\gamma_{inst}$ [-]	1,00					3)
<b>Zniszczenie przez wyłamanie stożka betonu <sup>2)</sup></b>							
<b>HST3 oraz HST3-R</b>							
Czynna głębokość osadzenia	$h_{ef,2}$ [mm]	47	60	70	85	101	3)
Czynna głębokość osadzenia	$h_{ef,1}$ [mm]	3)	3)	50	3)	3)	3)
Montażowy współczynnik bezpieczeństwa	$\gamma_{inst}$ [-]	1,00					3)

<sup>1)</sup> W przypadku braku innych przepisów krajowych.

<sup>2)</sup> Dla zniszczenia przez wyłamanie stożka betonu oraz rozłupanie podłoża patrz → norma EN 1992-4:2018.

<sup>3)</sup> Nie określono parametrów.

**Metalowa kotwa rozporowa Hilti HST, HST-R, HST-HCR, HST3, HST3-R**

**Charakterystyka produktu**

Nośność charakterystyczna na rozciąganie dla kategorii właściwości C2



**Tabela C13 ciąg dalszy**

		M8	M10	M12	M16	M20	M24
<b>Zniszczenie przez rozłupanie podłoża<sup>2)</sup></b>							
<b>HST3 oraz HST3-R</b>							
Czynna głębokość osadzenia	$h_{ef,2}$ [mm]	47	60	70	85	101	<sup>3)</sup>
Czynna głębokość osadzenia	$h_{ef,1}$ [mm]	<sup>3)</sup>	<sup>3)</sup>	50	<sup>3)</sup>	<sup>3)</sup>	<sup>3)</sup>
Montażowy współczynnik bezpieczeństwa	$\gamma_{inst}$ [-]	1,00					<sup>3)</sup>

<sup>1)</sup> W przypadku braku innych przepisów krajowych.

<sup>2)</sup> Dla zniszczenia przez wyłamanie stożka betonu oraz rozłupanie podłoża patrz → norma EN 1992-4:2018.

<sup>3)</sup> Nie określono parametrów.

**Tabela C14: Przemieszczenia pod wpływem sejsmicznych obciążeń rozciągających dla metalowych kotew rozporowych Hilti HST oraz HST-R, kategoria właściwości C2**

		M8	M10	M12	M16	M20	M24
<b>HST oraz HST-R</b>							
Czynna głębokość osadzenia	$h_{ef,2}$ [mm]	47	60	70	85	101	<sup>1)</sup>
Przemieszczenie SGU	$\delta_{N,C2(SGU)}$ [mm]	2,7	3,9	5,2	5,2	6,9	<sup>1)</sup>
Przemieszczenie SGN	$\delta_{N,C2(SGN)}$ [mm]	10,5	13,7	13,9	11,9	18,4	<sup>1)</sup>
<b>HST</b>							
Czynna głębokość osadzenia	$h_{ef,1}$ [mm]	<sup>1)</sup>	<sup>1)</sup>	50	<sup>1)</sup>	<sup>1)</sup>	<sup>1)</sup>
Przemieszczenie SGU	$\delta_{N,C2(SGU)}$ [mm]	<sup>1)</sup>	<sup>1)</sup>	1,2	<sup>1)</sup>	<sup>1)</sup>	<sup>1)</sup>
Przemieszczenie SGN	$\delta_{N,C2(SGN)}$ [mm]	<sup>1)</sup>	<sup>1)</sup>	2,5	<sup>1)</sup>	<sup>1)</sup>	<sup>1)</sup>

<sup>1)</sup> Nie określono parametrów.

**Metalowa kotwa rozporowa Hilti HST, HST-R, HST-HCR, HST3, HST3-R**

**Charakterystyka produktu**

Nośność charakterystyczna na rozciąganie oraz przemieszczenia pod wpływem obciążeń rozciągających dla kategorii właściwości C2





**Tabela C15: Nośność charakterystyczna na ścinanie dla obciążeń sejsmicznych dla metalowej kotwy rozporowej Hilti HST3 oraz HST3-R, kategoria właściwości C2**

	M8	M10	M12	M16	M20	M24
<b>Zniszczenie stali</b>						
<b>HST</b>						
Nośność charakterystyczna $V_{Rk,s,C2}$ [kN]	3)	14,3	21,0	41,3	3)	3)
Częściowy współczynnik bezpieczeństwa $\gamma_{Ms,C2}$ 1) [-]	3)	1,25			3)	3)
<b>HST-R</b>						
Nośność charakterystyczna $V_{Rk,s,C2}$ [kN]	3)	12,0	18,0	37,5	3)	3)
Częściowy współczynnik bezpieczeństwa $\gamma_{Ms,C2}$ 1) [-]	3)	1,25		1,30	3)	3)
<b>Zniszczenie przez wyłupanie betonu 2)</b>						
<b>HST oraz HST-R</b>						
Montażowy współczynnik bezpieczeństwa $\gamma_{inst}$ [-]	3)	1,00			3)	3)
<b>Zniszczenie krawędzi podłoża betonowego 2)</b>						
<b>HST oraz HST-R</b>						
Montażowy współczynnik bezpieczeństwa $\gamma_{inst}$ [-]	3)	1,00			3)	3)

1) W przypadku braku innych przepisów krajowych.

2) Dla zniszczenia przez wyłupanie betonu oraz zniszczenia krawędzi podłoża betonowego patrz → norma EN 1992-4:2018.

3) Nie określono parametrów.

**Tabela C16: Przemieszczenia pod wpływem sejsmicznych obciążeń ścinających dla metalowych kotew rozporowych Hilti HST oraz HST-R, kategoria właściwości C2**

	M8	M10	M12	M16	M20	M24
<b>HST oraz HST-R</b>						
Przemieszczenie SGU $\delta_{v,C2}(SGU)$ [mm]	1)	4,2	5,3	5,7	1)	1)
Przemieszczenie SGN $\delta_{v,C2}(SGN)$ [mm]	1)	7,5	7,9	8,9	1)	1)

1) Nie określono parametrów.

**Metalowa kotwa rozporowa Hilti HST, HST-R, HST-HCR, HST3, HST3-R**

**Charakterystyka produktu**

Nośność charakterystyczna na ścinanie oraz przemieszczenia pod wpływem obciążeń ścinających dla kategorii właściwości C2



**Tabela C17: Nośność charakterystyczna na ścinanie dla obciążeń sejsmicznych dla metalowej kotwy rozporowej Hilti HST3 oraz HST3-R, kategoria właściwości C2**

		M8	M10	M12	M16	M20	M24
<b>Zniszczenie stali</b>							
<b>HST3</b>							
Czynna głębokość osadzenia	$h_{ef,2}$ [mm]	47	60	70	85	101	3)
Nośność charakterystyczna	$V_{Rk,s,C2}$ [kN]	9,5	16,1	26,1	42,4	66,9	3)
Nośność charakterystyczna przy zastosowaniu zestawu do wypełniania	$V_{Rk,s,C2}$ [kN]	9,9	19,0	28,6	48,5	84,3	3)
Częściowy współczynnik bezpieczeństwa	$\gamma_{Ms,C2}^{1)}$ [-]	1,25					3)
Czynna głębokość osadzenia	$h_{ef,1}$ [mm]	3)	3)	50	3)	3)	3)
Nośność charakterystyczna	$V_{Rk,s,C2}$ [kN]	3)	3)	15,6	3)	3)	3)
Częściowy współczynnik bezpieczeństwa	$\gamma_{Ms,C2}^{1)}$ [-]	1,25					3)
<b>HST3-R</b>							
Czynna głębokość osadzenia	$h_{ef,2}$ [mm]	47	60	70	85	101	3)
Nośność charakterystyczna	$V_{Rk,s,C2}$ [kN]	8,1	15,7	22,4	42,6	49,5	3)
Nośność charakterystyczna przy zastosowaniu zestawu do wypełniania	$V_{Rk,s,C2}$ [kN]	9,9	17,2	27,6	42,5	67,4	3)
Częściowy współczynnik bezpieczeństwa	$\gamma_{Ms,C2}^{1)}$ [-]	1,25					3)
<b>Zniszczenie przez wyłupanie betonu <sup>2)</sup></b>							
<b>HST3 oraz HST3-R</b>							
Czynna głębokość osadzenia	$h_{ef,2}$ [mm]	47	60	70	85	101	3)
Czynna głębokość osadzenia	$h_{ef,1}$ [mm]	3)	3)	50	3)	3)	3)
Montażowy współczynnik bezpieczeństwa	$\gamma_{inst}$ [-]	1,00					3)
<b>Zniszczenie krawędzi podłoża betonowego <sup>2)</sup></b>							
<b>HST3 oraz HST3-R</b>							
Czynna głębokość osadzenia	$h_{ef,2}$ [mm]	47	60	70	85	101	3)
Czynna głębokość osadzenia	$h_{ef,1}$ [mm]	3)	3)	50	3)	3)	3)
Montażowy współczynnik bezpieczeństwa	$\gamma_{inst}$ [-]	1,00					3)

<sup>1)</sup> W przypadku braku innych przepisów krajowych.

<sup>2)</sup> Dla zniszczenia przez wyłupanie stożka betonu oraz rozłupanie podłoża patrz → norma EN 1992-4:2018.

<sup>3)</sup> Nie określono parametrów.

**Metalowa kotwa rozporowa Hilti HST, HST-R, HST-HCR, HST3, HST3-R**

**Charakterystyka produktu**

Nośność charakterystyczna na ścinanie dla kategorii właściwości C2



**Tabela C18: Przemieszczenia pod wpływem sejsmicznych obciążeń ścinających dla metalowych kotew rozporowych Hilti HST3 oraz HST3-R, kategoria właściwości C2**

			M8	M10	M12	M16	M20	M24
<b>HST3</b>								
Czynna głębokość osadzenia	$h_{ef,2}$	[mm]	47	60	70	85	101	<sup>1)</sup>
Przemieszczenie SGU	$\delta_{V,C2(SGU)}$	[mm]	3,4	4,0	4,6	4,8	5,2	<sup>1)</sup>
Przemieszczenie SGU przy zastosowaniu zestawu do wypełniania	$\delta_{V,C2(SGU)}$	[mm]	1,4	1,6	2,5	1,7	1,9	<sup>1)</sup>
Przemieszczenie SGN	$\delta_{V,C2(SGN)}$	[mm]	4,9	6,2	8,1	8,2	10,0	<sup>1)</sup>
Przemieszczenie SGN przy zastosowaniu zestawu do wypełniania	$\delta_{V,C2(SGN)}$	[mm]	4,3	4,4	7,2	3,9	5,3	<sup>1)</sup>
Czynna głębokość osadzenia	$h_{ef,1}$	[mm]	<sup>1)</sup>	<sup>1)</sup>	50	<sup>1)</sup>	<sup>1)</sup>	<sup>1)</sup>
Przemieszczenie SGU	$\delta_{V,C2(SGU)}$	[mm]	<sup>1)</sup>	<sup>1)</sup>	5,2	<sup>1)</sup>	<sup>1)</sup>	<sup>1)</sup>
Przemieszczenie SGN	$\delta_{V,C2(SGN)}$	[mm]	<sup>1)</sup>	<sup>1)</sup>	8,4	<sup>1)</sup>	<sup>1)</sup>	<sup>1)</sup>
<b>HST3-R</b>								
Czynna głębokość osadzenia	$h_{ef,2}$	[mm]	47	60	70	85	101	<sup>1)</sup>
Przemieszczenie SGU	$\delta_{V,C2(SGU)}$	[mm]	3,5	5,0	6,0	5,8	3,9	<sup>1)</sup>
Przemieszczenie SGU przy zastosowaniu zestawu do wypełniania	$\delta_{V,C2(SGU)}$	[mm]	1,6	1,6	2,0	1,9	2,2	<sup>1)</sup>
Przemieszczenie SGN	$\delta_{V,C2(SGN)}$	[mm]	7,5	9,1	10,1	12,3	7,0	<sup>1)</sup>
Przemieszczenie SGU przy zastosowaniu zestawu do wypełniania	$\delta_{V,C2(SGN)}$	[mm]	5,0	7,6	6,8	4,7	5,8	<sup>1)</sup>

<sup>1)</sup> Nie określono parametrów.

**Metalowa kotwa rozporowa Hilti HST, HST-R, HST-HCR, HST3, HST3-R**

**Charakterystyka produktu**

Przemieszczenia pod wpływem obciążeń ścinających dla kategorii właściwości C2



**Tabela C19: Nośność charakterystyczna na rozciąganie w warunkach pożaru dla metalowych kotew rozporowych Hilti HST, HST-R oraz HST-HCR w betonie zarysowanym i niezarysowanym**

				M8	M10	M12	M16	M20 <sup>1)</sup>	M24 <sup>1)</sup>
<b>Zniszczenie stali</b>									
<b>HST</b>									
Nośność charakterystyczna	R30	$N_{Rk,s,fi}$	[kN]	0,9	2,5	5,0	9,0	15,0	20,0
	R60	$N_{Rk,s,fi}$	[kN]	0,7	1,5	3,5	6,0	10,0	15,0
	R90	$N_{Rk,s,fi}$	[kN]	0,6	1,0	2,0	3,5	6,0	8,0
	R120	$N_{Rk,s,fi}$	[kN]	0,5	0,7	1,0	2,0	3,5	5,0
<b>HST-R oraz HST HCR</b>									
Nośność charakterystyczna	R30	$N_{Rk,s,fi}$	[kN]	4,9	11,8	17,2	32,0	49,9	71,9
	R60	$N_{Rk,s,fi}$	[kN]	3,6	8,4	12,2	22,8	35,5	51,2
	R90	$N_{Rk,s,fi}$	[kN]	2,4	5,0	7,3	13,5	21,1	30,4
	R120	$N_{Rk,s,fi}$	[kN]	1,7	3,3	4,8	8,9	13,9	20,0
<b>Zniszczenie przez wyciągnięcie kotwy</b>									
<b>HST</b>									
Nośność charakterystyczna w betonie klasy $\geq C20/25$	R30	$N_{Rk,p,fi}$	[kN]	1,3	2,3	3,0	5,0	7,5	10,0
	R60	$N_{Rk,p,fi}$	[kN]						
	R90	$N_{Rk,p,fi}$	[kN]						
	R120	$N_{Rk,p,fi}$	[kN]						
<b>HST-R oraz HST-HCR</b>									
Nośność charakterystyczna w betonie klasy $\geq C20/25$	R30	$N_{Rk,p,fi}$	[kN]	1,3	2,3	3,0	6,3	7,5	10,0
	R60	$N_{Rk,p,fi}$	[kN]						
	R90	$N_{Rk,p,fi}$	[kN]						
	R120	$N_{Rk,p,fi}$	[kN]						

<sup>1)</sup> Wyłącznie kotwa HST i HST-R

W przypadku braku innych przepisów krajowych dla nośności w warunkach pożaru zalecany jest częściowy współczynnik bezpieczeństwa  $\gamma_{M,fi} = 1,0$ .

**Metalowa kotwa rozporowa Hilti HST, HST-R, HST-HCR, HST3, HST3-R**

**Charakterystyka produktu**

Wartości charakterystyczne nośności pod wpływem obciążeń rozciągających w warunkach pożaru w betonie zarysowanym i niezarysowanym



**Tabela C19Tabela C19 ciąg dalszy**

				M8	M10	M12	M16	M20 <sup>1)</sup>	M24 <sup>1)</sup>
<b>Zniszczenie przez wyłamanie stożka betonu</b>									
<b>HST, HST-R oraz HST-HCR</b>									
Nośność charakterystyczna w betonie klasy $\geq$ C20/25	R30	$N_{RK,c,fi}^0$	[kN]	2,7	5,0	7,4	11,0	18,5	31,4
	R60	$N_{RK,c,fi}^0$	[kN]						
	R90	$N_{RK,c,fi}^0$	[kN]						
	R120	$N_{RK,c,fi}^0$	[kN]	2,2	4,0	5,9	8,8	14,8	25,2
Rozstaw kotew	$S_{cr,N}$	[mm]	4 $h_{ef}$						
	$S_{min}$	[mm]	40	55	60	70	100	125	
Odległość od krawędzi podłoża	$C_{cr,N}$	[mm]	2 $h_{ef}$						
	$C_{min}$	[mm]	Oddziaływanie pożaru z jednej strony: 2 $h_{ef}$ Oddziaływanie pożaru z więcej, niż jednej strony: $\geq$ 300						

<sup>1)</sup> Wyłącznie kotwa HST i HST-R

W przypadku braku innych przepisów krajowych dla nośności w warunkach pożaru zalecany jest częściowy współczynnik bezpieczeństwa  $\gamma_{M,fi} = 1,0$ .

**Metalowa kotwa rozporowa Hilti HST, HST-R, HST-HCR, HST3, HST3-R**

**Charakterystyka produktu**

Wartości charakterystyczne nośności pod wpływem obciążeń rozciągających w warunkach pożaru w betonie zarysowanym i niezarysowanym





**Tabela C20: Nośność charakterystyczna na rozciąganie w warunkach pożaru dla metalowych kotew rozporowych Hilti HST3 oraz HST3-R w betonie zarysowanym i niezarysowanym**

			M8	M10	M12	M16	M20	M24
<b>Zniszczenie stali</b>								
<b>HST3</b>								
Czynna głębokość osadzenia	$h_{ef,2}$	[mm]	47	60	70	85	101	125
Nośność charakterystyczna	R30	$N_{Rk,s,fi}$ [kN]	0,9	2,4	5,2	9,7	15,2	21,9
	R60	$N_{Rk,s,fi}$ [kN]	0,8	1,8	3,7	6,8	10,6	15,3
	R90	$N_{Rk,s,fi}$ [kN]	0,7	1,2	2,1	3,9	6,0	8,7
	R120	$N_{Rk,s,fi}$ [kN]	0,6	0,9	1,3	2,4	3,8	5,4
<b>HST3-R</b>								
Czynna głębokość osadzenia	$h_{ef,2}$	[mm]	47	60	70	85	101	125
Nośność charakterystyczna	R30	$N_{Rk,s,fi}$ [kN]	4,9	11,8	17,1	31,9	49,8	71,8
	R60	$N_{Rk,s,fi}$ [kN]	3,6	8,4	12,2	22,8	35,5	51,2
	R90	$N_{Rk,s,fi}$ [kN]	2,4	5,0	7,3	13,6	21,2	30,6
	R120	$N_{Rk,s,fi}$ [kN]	1,7	3,3	4,8	9,0	14,1	20,3
<b>HST3</b>								
Czynna głębokość osadzenia	$h_{ef,1}$	[mm]	1)	40	50	65	1)	1)
Nośność charakterystyczna	R30	$N_{Rk,s,fi}$ [kN]	1)	1,5	2,3	4,4	1)	1)
	R60	$N_{Rk,s,fi}$ [kN]	1)	1,2	1,7	3,2	1)	1)
	R90	$N_{Rk,s,fi}$ [kN]	1)	0,9	1,1	2,1	1)	1)
	R120	$N_{Rk,s,fi}$ [kN]	1)	0,8	0,8	1,5	1)	1)
<b>HST3-R</b>								
Czynna głębokość osadzenia	$h_{ef,1}$	[mm]	1)	40	50	65	1)	1)
Nośność charakterystyczna	R30	$N_{Rk,s,fi}$ [kN]	1)	5,2	9,1	16,9	1)	1)
	R60	$N_{Rk,s,fi}$ [kN]	1)	3,7	6,8	12,6	1)	1)
	R90	$N_{Rk,s,fi}$ [kN]	1)	2,5	4,5	8,4	1)	1)
	R120	$N_{Rk,s,fi}$ [kN]	1)	2,0	3,3	6,2	1)	1)

<sup>1)</sup> Nie określono parametrów.

W przypadku braku innych przepisów krajowych dla nośności w warunkach pożaru zalecany jest częściowy współczynnik bezpieczeństwa  $\gamma_{M,fi} = 1,0$ .

**Metalowa kotwa rozporowa Hilti HST, HST-R, HST-HCR, HST3, HST3-R**

**Charakterystyka produktu**

Wartości charakterystyczne nośności pod wpływem obciążeń rozciągających w warunkach pożaru w betonie zarysowanym i niezarysowanym



Załącznik C26

**Tabela C20Tabela C20 ciąg dalszy**

			M8	M10	M12	M16	M20	M24
<b>Zniszczenie przez wyciągnięcie kotwy</b>								
<b>HST3 oraz HST3-R</b>								
Czynna głębokość osadzenia	$h_{ef,2}$	[mm]	47	60	70	85	101	125
Nośność charakterystyczna w betonie klasy $\geq$ C20/25	R30	$N_{Rk,p,fi}$ [kN]	1,9	3,0	5,0	7,1	9,1	12,6
	R60	$N_{Rk,p,fi}$ [kN]						
	R90	$N_{Rk,p,fi}$ [kN]						
	R120	$N_{Rk,p,fi}$ [kN]						
<b>HST3 oraz HST3-R</b>								
Czynna głębokość osadzenia	$h_{ef,1}$	[mm]	1) <sup>1)</sup>	40	50	65	1) <sup>1)</sup>	1) <sup>1)</sup>
Nośność charakterystyczna w betonie klasy $\geq$ C20/25	R30	$N_{Rk,p,fi}$ [kN]	1) <sup>1)</sup>	2,3	3,2	4,7	1) <sup>1)</sup>	1) <sup>1)</sup>
	R60	$N_{Rk,p,fi}$ [kN]						
	R90	$N_{Rk,p,fi}$ [kN]						
	R120	$N_{Rk,p,fi}$ [kN]						

<sup>1)</sup> Nie określono parametrów.

W przypadku braku innych przepisów krajowych dla nośności w warunkach pożaru zalecany jest częściowy współczynnik bezpieczeństwa  $\gamma_{M,fi} = 1,0$ .

**Metalowa kotwa rozporowa Hilti HST, HST-R, HST-HCR, HST3, HST3-R**

**Charakterystyka produktu**

Wartości charakterystyczne nośności pod wpływem obciążeń rozciągających w warunkach pożaru w betonie zarysowanym i niezarysowanym



**Tabela C20 ciąg dalszy**

		M8	M10	M12	M16	M20	M24	
<b>Zniszczenie przez wyłamanie stożka betonu</b>								
<b>HST3 oraz HST3-R</b>								
Czynna głębokość osadzenia	$h_{ef,2}$ [mm]	47	60	70	85	101	125	
Nośność charakterystyczna w betonie klasy $\geq C20/25$	R30 $N_{RK,c,fi}^0$ [kN]	2,7	5,0	7,4	12,0	18,5	31,4	
	R60 $N_{RK,c,fi}^0$ [kN]							
	R90 $N_{RK,c,fi}^0$ [kN]							
	R120 $N_{RK,c,fi}^0$ [kN]	2,2	4,0	5,9	9,6	14,8	25,2	
Rozstaw kotew	$S_{cr,N}$ [mm]	4 $h_{ef}$						
	$S_{min}$ [mm]	35	40	50	65	90	125	
Odległość od krawędzi podłoża	$C_{cr,N}$ [mm]	2 $h_{ef}$						
	$C_{min}$ [mm]	Oddziaływanie pożaru z jednej strony: 2 $h_{ef}$ Oddziaływanie pożaru z więcej, niż jednej strony: $\geq 300$						
<b>HST3 oraz HST3-R</b>								
Czynna głębokość osadzenia	$h_{ef,1}$ [mm]	1)	40	50	65	1)	1)	
Nośność charakterystyczna w betonie klasy $\geq C20/25$	R30 $N_{RK,c,fi}^0$ [kN]	1)	1,8	3,2	6,1	1)	1)	
	R60 $N_{RK,c,fi}^0$ [kN]							
	R90 $N_{RK,c,fi}^0$ [kN]							
	R120 $N_{RK,c,fi}^0$ [kN]	1)	1,5	2,5	4,9	1)	1)	
Rozstaw kotew	$S_{cr,N}$ [mm]	1)	4 $h_{ef}$				1)	1)
	$S_{min}$ [mm]	1)	40	50	65	1)	1)	
Odległość od krawędzi podłoża	$C_{cr,N}$ [mm]	1)	2 $h_{ef}$				1)	1)
	$C_{min}$ [mm]	Oddziaływanie pożaru z jednej strony: 2 $h_{ef}$ Oddziaływanie pożaru z więcej, niż jednej strony: $\geq 300$						

1) Nie określono parametrów.

W przypadku braku innych przepisów krajowych dla nośności w warunkach pożaru zalecany jest częściowy współczynnik bezpieczeństwa  $\gamma_{M,fi} = 1,0$ .

**Metalowa kotwa rozporowa Hilti HST, HST-R, HST-HCR, HST3, HST3-R**

**Charakterystyka produktu**

Wartości charakterystyczne nośności pod wpływem obciążeń rozciągających w warunkach pożaru w betonie zarysowanym i niezarysowanym





**Tabela C21: Nośność charakterystyczna na ścinanie w warunkach pożaru dla metalowych kotew rozporowych Hilti HST, HST-R oraz HST-HCR w betonie zarysowanym i niezarysowanym**

				M8	M10	M12	M16	M20 <sup>1)</sup>	M24 <sup>1)</sup>
<b>Zniszczenie stali bez oddziaływania momentu zginającego</b>									
<b>HST</b>									
Nośność charakterystyczna	R30	$V_{Rk,s,fi}$	[kN]	0,9	2,5	5,0	9,0	15,0	20,0
	R60	$V_{Rk,s,fi}$	[kN]	0,7	1,5	3,5	6,0	10,0	15,0
	R90	$V_{Rk,s,fi}$	[kN]	0,6	1,0	2,0	3,5	6,0	8,0
	R120	$V_{Rk,s,fi}$	[kN]	0,5	0,7	1,0	2,0	3,5	5,0
<b>HST-R oraz HST HCR</b>									
Nośność charakterystyczna	R30	$V_{Rk,s,fi}$	[kN]	4,9	11,8	17,2	32,0	49,9	71,9
	R60	$V_{Rk,s,fi}$	[kN]	3,6	8,4	12,2	22,8	35,5	51,2
	R90	$V_{Rk,s,fi}$	[kN]	2,4	5,0	7,3	13,5	21,1	30,4
	R120	$V_{Rk,s,fi}$	[kN]	1,7	3,3	4,8	8,9	13,9	20,0
<b>Zniszczenie stali z oddziaływaniem momentu zginającego</b>									
<b>HST</b>									
Nośność charakterystyczna	R30	$M^0_{Rk,s,fi}$	[Nm]	1,0	3,3	8,1	20,6	40,2	69,5
	R60	$M^0_{Rk,s,fi}$	[Nm]	0,8	2,4	5,7	14,4	28,1	48,6
	R90	$M^0_{Rk,s,fi}$	[Nm]	0,7	1,6	3,2	8,2	16,0	27,7
	R120	$M^0_{Rk,s,fi}$	[Nm]	0,6	1,2	2,0	5,1	9,9	17,2
<b>HST-R oraz HST HCR</b>									
Nośność charakterystyczna	R30	$M^0_{Rk,s,fi}$	[Nm]	5,0	15,2	26,6	67,7	132,3	228,6
	R60	$M^0_{Rk,s,fi}$	[Nm]	3,7	10,8	19,0	48,2	94,1	162,6
	R90	$M^0_{Rk,s,fi}$	[Nm]	2,4	6,4	11,3	28,6	55,9	96,6
	R120	$M^0_{Rk,s,fi}$	[Nm]	1,8	4,2	7,4	18,9	36,8	63,7

<sup>1)</sup> Wyłącznie kotwa HST i HST-R.

<sup>2)</sup> Nie określono parametrów.

W przypadku braku innych przepisów krajowych dla nośności w warunkach pożaru zalecany jest częściowy współczynnik bezpieczeństwa  $\gamma_{M,fi} = 1,0$ .

**Metalowa kotwa rozporowa Hilti HST, HST-R, HST-HCR, HST3, HST3-R**

**Charakterystyka produktu**

Wartości charakterystyczne nośności pod wpływem obciążeń ścinających w warunkach pożaru w betonie zarysowanym i niezarysowanym



**Załącznik C29**

**Tabela C21**Tabela C21 ciąg dalszy

		M8	M10	M12	M16	M20 <sup>1)</sup>	M24 <sup>1)</sup>
<b>Zniszczenie przez wylupanie betonu</b>							
<b>HST, HST-R oraz HST-HCR</b>							
Współczynnik dla wylupania betonu	$k_8$	[-]	2,00	2,00	2,20	2,50	2,50
Nośność charakterystyczna w betonie klasy $\geq$ C20/25	R30	$V_{Rk,cp,fi}^0$ [kN]	5,4	10,0	16,0	27,2	49,4
	R60	$V_{Rk,cp,fi}^0$ [kN]					
	R90	$V_{Rk,cp,fi}^0$ [kN]					
	R120	$V_{Rk,cp,fi}^0$ [kN]					
<b>Zniszczenie krawędzi podłoża betonowego</b>							
<b>HST, HST-R oraz HST-HCR</b>							
Wartość początkowa $V_{Rk,c,fi}^0$ nośności charakterystycznej w betonie klasy od C20/25 do C50/60 w warunkach pożaru może być określona ze wzoru:							
$V_{Rk,c,fi}^0 = 0,25 \times V_{Rk,c}^0 \quad (\leq R90) \qquad V_{Rk,c,fi}^0 = 0,20 \times V_{Rk,c}^0 \quad (R120)$							
gdzie $V_{Rk,c}^0$ jest wartością początkową nośności charakterystycznej dla betonu zarysowanego klasy C20/25 w standardowej temperaturze.							

<sup>1)</sup> Wyłącznie kotwa HST i HST-R.

<sup>2)</sup> Nie określono parametrów.

W przypadku braku innych przepisów krajowych dla nośności w warunkach pożaru zalecany jest częściowy współczynnik bezpieczeństwa  $\gamma_{M,fi} = 1,0$ .

**Metalowa kotwa rozporowa Hilti HST, HST-R, HST-HCR, HST3, HST3-R**

**Charakterystyka produktu**

Wartości charakterystyczne nośności pod wpływem obciążeń ścinających w warunkach pożaru w betonie zarysowanym i niezarysowanym



**Tabela C22: Nośność charakterystyczna na ścinanie w warunkach pożaru dla metalowych kotew rozporowych Hilti HST3 oraz HST3-R w betonie zarysowanym i niezarysowanym**

			M8	M10	M12	M16	M20	M24
<b>Zniszczenie stali bez oddziaływania momentu zginającego</b>								
<b>HST3</b>								
Czynna głębokość osadzenia	$h_{ef,2}$	[mm]	47	60	70	85	101	125
Nośność charakterystyczna	R30	$V_{Rk,s,fi}$ [kN]	0,9	2,4	5,2	9,7	15,2	21,9
	R60	$V_{Rk,s,fi}$ [kN]	0,8	1,8	3,7	6,8	10,6	15,3
	R90	$V_{Rk,s,fi}$ [kN]	0,7	1,2	2,1	3,9	6,0	8,7
	R120	$V_{Rk,s,fi}$ [kN]	0,6	0,9	1,3	2,4	3,8	5,4
<b>HST3-R</b>								
Czynna głębokość osadzenia	$h_{ef,2}$	[mm]	47	60	70	85	101	125
Nośność charakterystyczna	R30	$V_{Rk,s,fi}$ [kN]	4,9	11,8	17,1	31,9	49,8	71,8
	R60	$V_{Rk,s,fi}$ [kN]	3,6	8,4	12,2	22,8	35,5	51,2
	R90	$V_{Rk,s,fi}$ [kN]	2,4	5,0	7,3	13,6	21,2	30,6
	R120	$V_{Rk,s,fi}$ [kN]	1,7	3,3	4,8	9,0	14,1	20,3
<b>HST3</b>								
Czynna głębokość osadzenia	$h_{ef,1}$	[mm]	1) <sup>1)</sup>	40	50	65	1) <sup>1)</sup>	1) <sup>1)</sup>
Nośność charakterystyczna	R30	$V_{Rk,s,fi}$ [kN]	1) <sup>1)</sup>	1,5	2,3	4,4	1) <sup>1)</sup>	1) <sup>1)</sup>
	R60	$V_{Rk,s,fi}$ [kN]	1) <sup>1)</sup>	1,2	1,7	3,2	1) <sup>1)</sup>	1) <sup>1)</sup>
	R90	$V_{Rk,s,fi}$ [kN]	1) <sup>1)</sup>	0,9	1,1	2,1	1) <sup>1)</sup>	1) <sup>1)</sup>
	R120	$V_{Rk,s,fi}$ [kN]	1) <sup>1)</sup>	0,8	0,8	1,5	1) <sup>1)</sup>	1) <sup>1)</sup>
<b>HST3-R</b>								
Czynna głębokość osadzenia	$h_{ef,1}$	[mm]	1) <sup>1)</sup>	40	50	65	1) <sup>1)</sup>	1) <sup>1)</sup>
Nośność charakterystyczna	R30	$V_{Rk,s,fi}$ [kN]	1) <sup>1)</sup>	5,2	9,1	16,9	1) <sup>1)</sup>	1) <sup>1)</sup>
	R60	$V_{Rk,s,fi}$ [kN]	1) <sup>1)</sup>	3,7	6,8	12,6	1) <sup>1)</sup>	1) <sup>1)</sup>
	R90	$V_{Rk,s,fi}$ [kN]	1) <sup>1)</sup>	2,5	4,5	8,4	1) <sup>1)</sup>	1) <sup>1)</sup>
	R120	$V_{Rk,s,fi}$ [kN]	1) <sup>1)</sup>	2,0	3,3	6,2	1) <sup>1)</sup>	1) <sup>1)</sup>

<sup>1)</sup> Nie określono parametrów.

W przypadku braku innych przepisów krajowych dla nośności w warunkach pożaru zalecany jest częściowy współczynnik bezpieczeństwa  $\gamma_{M,fi} = 1,0$ .

**Metalowa kotwa rozporowa Hilti HST, HST-R, HST-HCR, HST3, HST3-R**

**Charakterystyka produktu**

Wartości charakterystyczne nośności pod wpływem obciążeń ścinających w warunkach pożaru w betonie zarysowanym i niezarysowanym



**Tabela C22 ciąg dalszy**

			M8	M10	M12	M16	M20	M24
<b>Zniszczenie stali z oddziaływaniem momentu zginającego</b>								
<b>HST3</b>								
Czynna głębokość osadzenia	$h_{ef,2}$	[mm]	47	60	70	85	101	125
Nośność charakterystyczna	R30	$M_{Rk,s,fi}^0$ [Nm]	0,9	3,1	8,1	20,6	40,2	69,5
	R60	$M_{Rk,s,fi}^0$ [Nm]	0,8	2,4	5,7	14,4	28,1	48,6
	R90	$M_{Rk,s,fi}^0$ [Nm]	0,7	1,6	3,2	8,2	16,0	27,7
	R120	$M_{Rk,s,fi}^0$ [Nm]	0,6	1,2	2,0	5,1	10,0	17,2
<b>HST3-R</b>								
Czynna głębokość osadzenia	$h_{ef,2}$	[mm]	47	60	70	85	101	125
Nośność charakterystyczna	R30	$M_{Rk,s,fi}^0$ [Nm]	5,0	15,2	26,6	67,6	132,0	228,2
	R60	$M_{Rk,s,fi}^0$ [Nm]	3,7	10,8	19,0	48,2	94,1	162,7
	R90	$M_{Rk,s,fi}^0$ [Nm]	2,4	6,5	11,3	28,8	56,3	97,2
	R120	$M_{Rk,s,fi}^0$ [Nm]	1,8	4,3	7,5	19,1	37,3	64,5
<b>HST3</b>								
Czynna głębokość osadzenia	$h_{ef,1}$	[mm]	1) <sup>1)</sup>	40	50	65	1) <sup>1)</sup>	1) <sup>1)</sup>
Nośność charakterystyczna	R30	$M_{Rk,s,fi}^0$ [Nm]	1) <sup>1)</sup>	2,0	3,6	9,3	1) <sup>1)</sup>	1) <sup>1)</sup>
	R60	$M_{Rk,s,fi}^0$ [Nm]	1) <sup>1)</sup>	1,6	2,7	6,9	1) <sup>1)</sup>	1) <sup>1)</sup>
	R90	$M_{Rk,s,fi}^0$ [Nm]	1) <sup>1)</sup>	1,2	1,8	4,5	1) <sup>1)</sup>	1) <sup>1)</sup>
	R120	$M_{Rk,s,fi}^0$ [Nm]	1) <sup>1)</sup>	1,0	1,3	3,3	1) <sup>1)</sup>	1) <sup>1)</sup>
<b>HST3-R</b>								
Czynna głębokość osadzenia	$h_{ef,1}$	[mm]	1) <sup>1)</sup>	40	50	65	1) <sup>1)</sup>	1) <sup>1)</sup>
Nośność charakterystyczna	R30	$M_{Rk,s,fi}^0$ [Nm]	1) <sup>1)</sup>	6,7	14,1	35,9	1) <sup>1)</sup>	1) <sup>1)</sup>
	R60	$M_{Rk,s,fi}^0$ [Nm]	1) <sup>1)</sup>	4,8	10,5	26,8	1) <sup>1)</sup>	1) <sup>1)</sup>
	R90	$M_{Rk,s,fi}^0$ [Nm]	1) <sup>1)</sup>	3,2	7,0	17,7	1) <sup>1)</sup>	1) <sup>1)</sup>
	R120	$M_{Rk,s,fi}^0$ [Nm]	1) <sup>1)</sup>	2,6	5,2	13,2	1) <sup>1)</sup>	1) <sup>1)</sup>

<sup>1)</sup> Nie określono parametrów.

W przypadku braku innych przepisów krajowych dla nośności w warunkach pożaru zalecany jest częściowy współczynnik bezpieczeństwa  $\gamma_{M,fi} = 1,0$ .

**Metalowa kotwa rozporowa Hilti HST, HST-R, HST-HCR, HST3, HST3-R**

**Charakterystyka produktu**

Wartości charakterystyczne nośności pod wpływem obciążeń ścinających w warunkach pożaru w betonie zarysowanym i niezarysowanym





Tabela C22Tabela C22 ciąg dalszy

			M8	M10	M12	M16	M20	M24
<b>Zniszczenie przez wyłupanie betonu</b>								
<b>HST3 oraz HST3-R</b>								
Czynna głębokość osadzenia	$h_{ef,2}$	[mm]	47	60	70	85	101	125
Współczynnik dla wyłupania betonu	$k_8$	[-]	2,62	2,67	2,78	3,41	3,20	2,50
Nośność charakterystyczna w betonie klasy $\geq$ C20/25	R30	$V_{RK,cp,fi}^0$ [kN]	7,0	13,0	20,7	40,8	37,0	62,8
	R60	$V_{RK,cp,fi}^0$ [kN]						
	R90	$V_{RK,cp,fi}^0$ [kN]						
	R120	$V_{RK,cp,fi}^0$ [kN]						
<b>HST3 oraz HST3-R</b>								
Czynna głębokość osadzenia	$h_{ef,1}$	[mm]	1)	40	50	65	1)	1)
Współczynnik dla wyłupania betonu	$k_8$	[-]	1)	2,67	2,78	3,41	1)	1)
Nośność charakterystyczna w betonie klasy $\geq$ C20/25	R30	$V_{RK,cp,fi}^0$ [kN]	1)	4,7	8,9	20,8	1)	1)
	R60	$V_{RK,cp,fi}^0$ [kN]						
	R90	$V_{RK,cp,fi}^0$ [kN]						
	R120	$V_{RK,cp,fi}^0$ [kN]						
<b>Zniszczenie krawędzi podłoża betonowego</b>								
<b>HST3 oraz HST3-R</b>								
Wartość początkowa $V_{RK,c,fi}^0$ nośności charakterystycznej w betonie klasy od C20/25 do C50/60 w warunkach pożaru może być określona ze wzoru:								
$V_{RK,c,fi}^0 = 0,25 \times V_{RK,c}^0 \quad (\leq R90) \qquad V_{RK,c,fi}^0 = 0,20 \times V_{RK,c}^0 \quad (R120)$								
gdzie $V_{RK,c}^0$ jest wartością początkową nośności charakterystycznej dla betonu zarysowanego klasy C20/25 w standardowej temperaturze.								

1) Nie określono parametrów.

W przypadku braku innych przepisów krajowych dla nośności w warunkach pożaru zalecany jest częściowy współczynnik bezpieczeństwa  $\gamma_{M,fi} = 1,0$ .**Metalowa kotwa rozporowa Hilti HST, HST-R, HST-HCR, HST3, HST3-R****Charakterystyka produktu**

Wartości charakterystyczne nośności pod wpływem obciążeń ścinających w warunkach pożaru w betonie zarysowanym i niezarysowanym



-----koniec dokumentu-----

Ja, tłumacz przysięgły języka angielskiego mgr Agnieszka Modrzejewska-Fryzewska, TP 4738/05, zaświadczam zgodność niniejszego tłumaczenia z okazanym mi dokumentem w języku angielskim 2 listopada 2020r.

Repertorium nr 08/2020

Tłumacz przysięgły

*Agnieszka Modrzejewska-Fryzewska*

Agnieszka Modrzejewska-Fryzewska

