

Air Conditioning
Technical Data

RWEYQ-T9



- > RWEYQ8T9Y1B
- > RWEYQ10T9Y1B
- > RWEYQ12T9Y1B
- > RWEYQ14T9Y1B

TABLE OF CONTENTS

RWEYQ-T9

1	Features	2
2	Specifications	3
	Technical Specifications	3
	Electrical Specifications	4
	Technical Specifications	5
	Technical Specifications	6
	Electrical Specifications	6
	Electrical Specifications	7
3	Options	8
4	Combination table	9
5	Capacity tables	10
	Capacity Table Legend	10
	Capacity Correction Factor	11
6	Dimensional drawings	12
7	Centre of gravity	13
8	Piping diagrams	14
9	Wiring diagrams	15
	Wiring Diagrams - Three Phase	15
10	External connection diagrams	17
11	Sound data	18
	Sound Power Spectrum	18
	Sound Pressure Spectrum	20
12	Installation	22
	Installation Method	22
	Refrigerant Pipe Selection	23
13	Operation range	28

1 Features

Ideal for high rise buildings, using water as heat source

- Environmental conscious solution: reduced CO2 emissions thanks to the use of geothermal energy as a renewable energy source and typical lower refrigerant levels making it ideal to comply with EN378
- Covers all thermal needs of a building via a single point of contact: accurate temperature control, ventilation, air handling units, Biddle air curtains and hot water
- Unique zero heat dissipation principle obviates the need for ventilation or cooling in the technical room, maximising installation flexibility
- Wide range of indoor units: either connect VRV or stylish indoor units such as Daikin Emura, Nexura ...
- Incorporates VRV IV standards & technologies: Variable Refrigerant Temperature, VRV configurator, 7-segment display and full inverter compressors
- Customize your VRV for best seasonal efficiency & comfort with the weather dependant Variable Refrigerant Temperature function. Increased seasonal efficiency and no more cold draft by supply of high outblow temperatures
- Developed for easy installation and servicing: choice between top or front connection for refrigerant piping and rotating switch box for easy access to serviceable parts
- Compact & lightweight design can be stacked for maximum space saving: 42HP can be installed in less than 0,5m² floorspace
- 2-stage heat recovery: first stage between indoor units, second stage between outdoor units thanks to the storage of energy in the water circuit
- Unified model for heat pump and heat recovery version and geothermal and standard operation
- Variable Water Flow control option increases flexibility and control
- 2 analogue input signals allowing external control of ON-OFF, operation mode, error signal, ...
- Easy compliance with F-gas regulation thanks to automated refrigerant containment check
- The ability to control each conditioned zone individually keeps VRV system running costs to an absolute minimum
- Spread your installation cost by phased installation
- Keep your system in top condition via our i-Net service: 24/7 monitoring for maximum efficiency, extended lifetime, immediate service support thanks to failure prediction and a clear understanding of operability and usage



Inverter

2 Specifications

2-1 Technical Specifications					RWEYQ8T9	RWEYQ10T9	RWEYQ12T9	RWEYQ14T9
Capacity range				HP	8	10	12	14
Cooling capacity	Nom.	30°C inlet water temperature	Nom. Waterflow	kW	22.4 (1)	28.0 (1)	33.5 (1)	40.0 (1)
				HP				
Heating capacity	Nom.	20°C inlet water temperature	Nom. Waterflow	kW	25.0 (2)	31.5 (2)	37.5 (2)	45.0 (2)
				HP				
Power input - 50Hz	Cooling	30°C inlet water temperature	Nom. Waterflow	kW	3.5 (1)	4.9 (1)	6.0 (1)	7.9 (1)
				HP				
	Heating	20°C inlet water temperature	Nom. Waterflow	kW	3.9 (2)	4.9 (2)	6.2 (2)	8.4 (2)
				HP				
Capacity control	Method				Inverter controlled			
EER at nom. capacity	30°C inlet water temperature	Nom. Waterflow	kW/kW		6.40 (1)	5.75 (1)	5.55 (1)	5.04 (1)
COP at nom. capacity	20°C inlet water temperature	Nom. Waterflow	kW/kW		6.50 (2)	6.40 (2)	6.10 (2)	5.37 (2)
Maximum number of connectable indoor units					64			
Indoor index connection	Min.				100	125	150	175
	Nom.				200	250	300	350
	Max.				300	375	450	525
Dimensions	Unit	Height	mm	980				
		Width	mm	767				
		Depth	mm	560				
	Packed unit	Height	mm	1,105				
		Width	mm	880				
		Depth	mm	670				
Weight	Unit			kg	185			
	Packed unit			kg	198			
Packing	Material				Carton			
	Weight				kg	264		
Packing 2	Material				Wood			
	Weight				kg	774		
Packing 3	Material				Plastic			
	Weight				kg	5		
Casing	Colour				Ivory white			
	Material				Painted galvanized steel plate			
Heat exchanger	Type				Brazen plate			
	Max. allowable water pressure			bar	37.0			
	Nominal water flow			l/min	96.00	120.00		
	Pressure drop			kPa	16.0	26.0		
Compressor	Quantity				1			
	Type				Hermetically sealed scroll inverter compressor			
	Crankcase heater			W	33			
Fan	Air flow rate	Cooling	Nom.	m ³ /min	-			
	External static pressure	Max.		Pa	-			
	Type				-			
Sound power level	Cooling	Nom.		dBA	65 (3)	71 (3)	72 (3)	74 (3)
Sound pressure level	Cooling	Nom.		dBA	48 (3)	50 (3)	56 (3)	58 (3)

2 Specifications

2

2-1 Technical Specifications				RWEYQ8T9	RWEYQ10T9	RWEYQ12T9	RWEYQ14T9	
Operation range	Cooling	Min.-Max.		°CDB		---		
	Heating	Min.-Max.		°CWB		---		
	Inlet water temperature	Cooling	Min.-Max.	°CDB		10-45		
		Heating	Min.-Max.	°CWB		10-45		
	Temperature around casing	Min.		°CDB		0		
		Max.		°CDB		40		
Humidity around casing	Cooling	Max.		%		80		
	Heating	Max.		%		80		
Refrigerant	Type			R-410A				
	GWP			20,875.0				
	Charge			TCO ₂ eq	16.5		20.0	
				kg	7.90		9.60	
Control			Inverter					
Refrigerant oil	Type			Daphne FVC68D				
	Charged volume			l		1.4		1.5
Piping connections	Liquid	Type		Braze connection				
		OD		mm		9,52		12,7
	Gas	Type		Braze connection				
		OD		mm		19.1 (4)		22.2 (4) / 28.6 (4)
	HP/LP gas	OD		mm		15.90 (5) / 19.10 (6)		19.10 (5) / 22.20 (6) / 19.10 (5) / 28.60 (6) / 22.20 (6) / 28.60 (5)
	Total piping length	System	Actual	m		165		
	Level difference	OU - IU	Outdoor unit in highest position	m		50		
Indoor unit in highest position			m		40			
IU - IU		Max.	m		30 (7)			
Safety devices	Item	01		High pressure switch				
		02		Inverter overload protector				
		03		PC board fuse				
PED	Category			Category II				
	Most critical part	Name		Liquid receiver				
		Ps*V	Bar*l		484			

2-2 Electrical Specifications				RWEYQ8T9	RWEYQ10T9	RWEYQ12T9	RWEYQ14T9	
Power supply	Name			Y1				
	Phase			3N-				
	Frequency			Hz		50		
	Voltage			V		380-415		
Voltage range	Min.		%		-10			
	Max.		%		10			
Current	Nominal running current (RLA) - 50Hz	Cooling	A		6.5		9.0 / 10.0 / 12.6	
Current - 50Hz	Zmax	List		No requirements				
	Minimum Ssc value		kVa		1,780 (8)			
	Minimum circuit amps (MCA)		A		22.3			
	Maximum fuse amps (MFA)		A		25			
	Total overcurrent amps (TOCA)		A		25.0			
Wiring connections - 50Hz	For power supply	Quantity		5G				
	For connection with indoor	Quantity		2				
		Remark		F1,F2				

2 Specifications

Notes

- (1) Indoor temperature : 27°CDB, 19°CWB; outdoor temperature : 35°CDB, 24°CWB
- (2) Indoor temperature : 20°CDB, 15°CWB; outdoor temperature : 7°CDB, 6°CWB.
- (3) Sound pressure level is a relative value, depending on the distance and acoustic environment. For more details, please refer to the sound level drawings.
- (4) In case of heat pump system, gas pipe is not used
- (5) In case of heat recovery system
- (6) In case of heat pump system
- (7) In case only VRV indoor units are connected
- (8) In accordance with EN/IEC 61000-3-12, it may be necessary to consult the distribution network operator to ensure that the equipment is connected only to a supply with Ssc ≥ minimum Ssc value

2-3 Technical Specifications					RWEYQ 16T9	RWEYQ 18T9	RWEYQ 20T9	RWEYQ 24T9	RWEYQ 26T9	RWEYQ 28T9	RWEYQ 30T9	RWEYQ 22T9	RWEYQ 32T9	RWEYQ 34T9
Capacity range				HP	16	18	20	24	26	28	30	22	32	34
Cooling capacity	Nom.	30°C inlet water temperature	Nom. Waterflow	kW	44.8 (1)	50.4 (1)	56.0 (1)	67.0 (1)	73.5 (1)	80.0 (1)	84.0 (1)	61.5 (1)	89.5 (1)	95.0 (1)
Heating capacity	Nom.	20°C inlet water temperature	Nom. Waterflow	kW	50.0 (2)	56.5 (2)	63.0 (2)	75.0 (2)	82.5 (2)	90.0 (2)	94.5 (2)	69.0 (2)	100.5 (2)	106.5 (2)
Power input - 50Hz	Cooling	30°C inlet water temperature	Nom. Waterflow	kW	7.0 (1)	8.4 (1)	9.7 (1)	12.1 (1)	13.8 (1)	15.9 (1)	14.6 (1)	10.9 (1)	15.8 (1)	16.9 (1)
Capacity control	Method				Inverter controlled									
EER at nom. capacity	30°C inlet water temperature	Nom. Waterflow	kW/kW		6.40 (1)	6.02 (1)	5.75 (1)	5.56 (1)	5.33 (1)	5.04 (1)	5.75 (1)	5.65 (1)	5.68 (1)	5.61 (1)
COP at nom. capacity	20°C inlet water temperature	Nom. Waterflow	kW/kW		6.50 (2)	6.44 (2)	6.40 (2)	6.10 (2)	5.74 (2)	5.37 (2)	6.40 (2)	6.23 (2)	6.28 (2)	6.19 (2)
Maximum number of connectable indoor units					64									
Indoor index connection	Min.				200	205	225	265	285	305	325	245	345	365
	Nom.				400	410	450	530	570	610	650	490	690	730
	Max.				600	615	675	795	855	915	975	735	1,035	1,095
Sound power level	Cooling	Nom.	dBA		68 (3)	72 (3)	74 (3)	75 (3)	76 (3)	77 (3)	76 (3)	75 (3)	76 (3)	
Sound pressure level	Cooling	Nom.	dBA		51 (3)	52 (3)	53 (3)	59 (3)	60 (3)	61 (3)	55 (3)	57 (3)	58 (3)	60 (3)
Piping connections	Liquid	Type			Braze connection									
		OD			mm	-								
	Gas	Type			Braze connection									
		Total piping length	System	Actual	m	165								
	Level difference	OU - IU	Outdoor unit in highest position	m	50									
			Indoor unit in highest position	m	40									
	IU - IU	Max.	m	30 (4)										
PED	Category				Category II									
	Most critical part	Name			Liquid receiver									
		Ps*V			Bar*l	484								

2 Specifications

2

2-4 Technical Specifications					RWEYQ36T9	RWEYQ38T9	RWEYQ40T9	RWEYQ42T9
Capacity range				HP	36	38	40	42
Cooling capacity	Nom.	30°C inlet water temperature	Nom. Waterflow	kW	100.5 (1)	107.0 (1)	113.5 (1)	120.0 (1)
					Heating capacity	Nom.	20°C inlet water temperature	Nom. Waterflow
Power input - 50Hz	Cooling	30°C inlet water temperature	Nom. Waterflow	kW	18.1 (1)	19.7 (1)	21.7 (1)	23.8 (1)
					Capacity control	Method		
EER at nom. capacity	30°C inlet water temperature	Nom. Waterflow	kW/kW	5.56 (1)	5.43 (1)	5.23 (1)	5.04 (1)	
COP at nom. capacity	20°C inlet water temperature	Nom. Waterflow	kW/kW	6.10 (2)	5.89 (2)	5.61 (2)	5.37 (2)	
Maximum number of connectable indoor units					64			
Indoor index connection	Min.				385	405	425	445
	Nom.				770	810	850	890
	Max.				1,155	1,215	1,275	1,335
Sound power level	Cooling	Nom.	dBA	77 (3)	78 (3)		79 (3)	
Sound pressure level	Cooling	Nom.	dBA	61 (3)	62 (3)		63 (3)	
Piping connections	Liquid	Type			Braze connection			
		OD	mm		-			
	Gas	Type			Braze connection			
		Total piping length	System	Actual	m	165		
	Level difference	OU - IU	Outdoor unit in highest position	m	50			
				Indoor unit in highest position	m	40		
IU - IU		Max.	m	30 (4)				
PED	Category				Category II			
	Most critical part	Name			Liquid receiver			
		Ps*V	Bar*l		484			

2-5 Electrical Specifications				RWEYQ 16T9	RWEYQ 18T9	RWEYQ 20T9	RWEYQ 24T9	RWEYQ 26T9	RWEYQ 28T9	RWEYQ 30T9	RWEYQ 22T9	RWEYQ 32T9	RWEYQ 34T9	
Voltage range	Min.		%	-10										
	Max.		%	10										
Current	Nominal running current (RLA) - 50Hz	Cooling	A	13.0	15.5	18.0	20.0	22.6	25.2	27.0	19.0	28.0	29.0	
Current - 50Hz	Zmax	List		No requirements										
	Minimum Ssc value			kVa	1,780 (5)	3,560 (5)				5,340 (5)	3,560 (5)	5,340 (5)		
	Minimum circuit amps (MCA)			A	22.3	44.6				66.9	44.6	66.9		
	Maximum fuse amps (MFA)			A	25	50				80	50	80		
	Total overcurrent amps (TOCA)			A	25.0	50.0				80.0	50.0	80.0		
Wiring connections - 50Hz	For power supply	Quantity		5G										
	For connection with indoor	Quantity		2										
		Remark		F1,F2										

2 Specifications

2-6 Electrical Specifications				RWEYQ36T9	RWEYQ38T9	RWEYQ40T9	RWEYQ42T9
Voltage range	Min.		%	-10			
	Max.		%	10			
Current	Nominal running current (RLA) - 50Hz	Cooling	A	29.9	32.5	35.1	37.7
Current - 50Hz	Zmax	List		No requirements			
	Minimum Ssc value		kVa	5,340 (5)			
	Minimum circuit amps (MCA)		A	66.9			
	Maximum fuse amps (MFA)		A	80			
	Total overcurrent amps (TOCA)		A	80.0			
Wiring connections - 50Hz	For power supply	Quantity		5G			
	For connection with indoor	Quantity		2			
		Remark		F1,F2			

Notes

(1) Indoor temperature : 27°CDB, 19°CWB; outdoor temperature : 35°CDB, 24°CWB

(2) Indoor temperature : 20°CDB, 15°CWB; outdoor temperature : 7°CDB, 6°CWB.

(3) Sound pressure level is a relative value, depending on the distance and acoustic environment. For more details, please refer to the sound level drawings.

(4) In case only VRV indoor units are connected

(5) In accordance with EN/IEC 61000-3-12, it may be necessary to consult the distribution network operator to ensure that the equipment is connected only to a supply with Ssc ≥ minimum Ssc value

In case of heat pump system, gas pipe is not used

In case of heat recovery system

In case of heat pump system

3 Options

3 - 1 Options

3

RWEYQ-T9							
Item		Single unit				Multi 2 unit	Multi 3 unit
		RWEYQ8	RWEYQ10	RWEYQ12	RWEYQ14		
Cool/heat selector (PCB)	See note 1.					BRP2A81	
Cool/heat selector (switch)	See note 1.					KRC19-26A	
Cool/heat selector (fixing box)	See note 1.					KJB111A	
External control adapter	Outdoor unit					DTA104A62	
Refnet header	Heat pump					KHRQ22M29H	
						KHRQ22M64H	
	Heat recovery					KHRQ22M75H	
						KHRQ23M29H	
Refnet joint	Heat pump					KHRQ23M64H	
						KHRQ23M75H	
	Heat recovery					KHRQ22M20T	
						KHRQ22M64T	
Outdoor multi-connection kit	Heat pump					KHRQ22M75T	
						KHRQ23M20T	
	Heat recovery					KHRQ23M29T9	
						KHRQ23M64T	
Communication cable	Heat pump					KHRQ23M75T	
						BHFQ22P1007	
	Heat recovery					BHFQ22P1517	
						BHFQ23P907	
Single BS unit						BHFQ23P1517	
						EKPCAB2	
						BS1Q10A7V1B	
						BS1Q16A7V1B	
Multi BS unit						BS1Q25A7V1B	
						BS4Q14AV1	
						BS6Q14AV1	
						BS8Q14AV1	
						BS10Q14AV1	
						BS12Q14AV1	
						BS16Q14AV1	

Notes

- In case of a heat recovery system, the cool/heat selector cannot be connected.
- It is not allowed to combine P-series BS units (single/multi) with A-series BS units (single/multi).
- For installations without special requirements towards fire regulations, the standard multi-connection kits can be used.
For installations with special requirements towards fire regulations, the insulation material can be replaced by using kits EKHBFG1 and EKHBFG2.
The 4 kits contain alternative insulation material that complies with EN13501-1:B-S3,dO and with BS476-7 (class 1).
To replace the insulation material, determine the required number of EKHBFG kits according to the table below.

2D108935A

4 Combination table

4 - 1 Combination Table

RWEYQ-T9

VRV4 Water Cooled standard combination table (multi)

	8HP	10HP	12HP	14HP
RWEYQ8	1			
RWEYQ10		1		
RWEYQ12			1	
RWEYQ14				1
RWEYQ16	2			
RWEYQ18	1	1		
RWEYQ20	FREE COMBINATION			
RWEYQ22	FREE COMBINATION			
RWEYQ24	FREE COMBINATION			
RWEYQ26	FREE COMBINATION			
RWEYQ28	FREE COMBINATION			
RWEYQ30	FREE COMBINATION			
RWEYQ32	FREE COMBINATION			
RWEYQ34	FREE COMBINATION			
RWEYQ36	FREE COMBINATION			
RWEYQ38	FREE COMBINATION			
RWEYQ40			1	2
RWEYQ42				3

3D108944

5 Capacity tables

5 - 1 Capacity Table Legend

5

In order to fulfill more your requirements on quick access of data in the format you require, we have developed a tool to consult capacity tables.

Below you can find the link to the capacity table database and an overview of all the tools we have to help you select the correct product:

- Capacity table database: lets you find back and export quickly the capacity information you are looking for based upon unit model, refrigerant temperature and connection ratio.

[Click here to access the capacity table viewer.](#)



- For more information about all our tools we offer [click here to see the overview](#) on my.daikin.eu



5 Capacity tables

5 - 2 Capacity Correction Factor

RWEYQ-T9

RWEYQ*T9 pressure drop

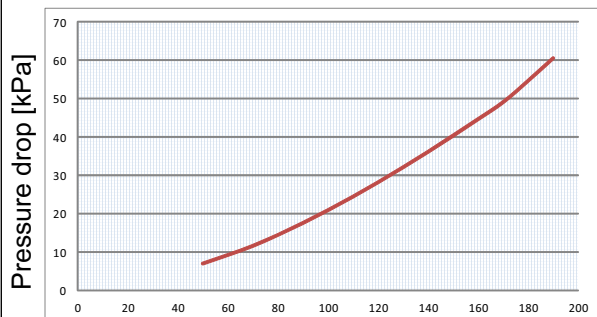

Water flow rate [l/min]

Accessory water filter pressure drop

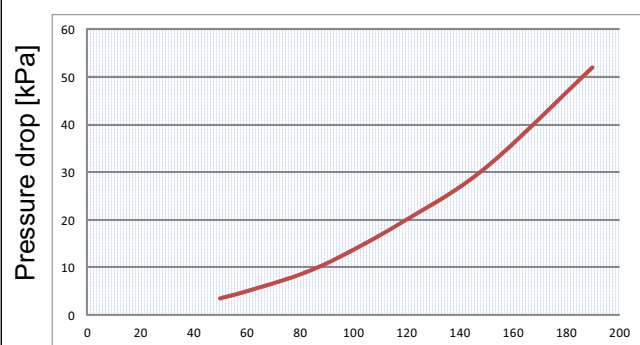

Water flow rate [l/min]

Notes

The values were measured during nominal cooling operation with an inlet water temperature of 30°C.

EG: Ethylene glycol

PG: Propylene glycol

ACH73: plate heat exchanger (100 plates)

Influence on performance

EG 30%: +0.5K during the condensation process, and -0.5K during the evaporation process.

EG 40%: +0.7K during the condensation process, and -0.7K during the evaporation process.

PG 30%: +1.3K during the condensation process, and -1.3K during the evaporation process.

PG 40%: +1.5K during the condensation process, and -1.5K during the evaporation process.

l/min	ACH73 // Delta pressure [kPa]				
	Water	30% EG	40% EG	30% PG	40% PG
50	5.4	6.9	7.0	7.2	7.5
60	7.4	9.4	9.6	9.8	10.2
70	9.7	12.2	12.5	12.8	13.3
80	12.3	15.5	15.9	16.2	16.9
90	15.2	19.1	19.6	20.1	20.8
100	18.4	23.2	23.7	24.3	25.2
110	21.9	27.6	28.2	28.9	30.0
120	25.7	32.2	33.1	33.9	35.1
130	29.7	37.5	38.4	39.3	40.7
140	34.1	43.0	44.0	45.1	46.8
150	38.8	48.9	50.1	51.2	53.2
160	43.8	55.2	56.5	57.8	60.0
170	49.1	61.9	63.3	64.8	67.3
180	54.7	68.9	70.5	72.2	74.9
190	60.6	76.3	78.1	80.0	83.0

Water filter	Delta pressure [kPa]
Flow [l/min]	Water
50	3.5
60	5
80	8.5
96	12.5
120	20
150	31
190	52

3D108933

6 Dimensional drawings

6 - 1 Dimensional Drawings

RWEYQ-T9

Top view

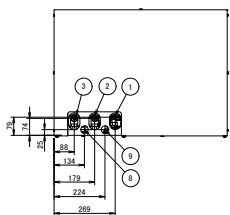

Item	Part name	Remark
1	Liquid pipe	See table 1.
2	Suction pipe	See table 2.
3	Gas pipe	See table 3.
4	Water IN connection	External pipe thread ISO 228-G1 1/4 B
5	Water OUT connection	External pipe thread ISO 228-G1 1/4 B
6	Drain outlet	Flexible hose (inside diameter: Ø 10mm)
7	Grounding terminal	M8
8	Power supply wiring intake	Ø 25
9	Cable inlet	Ø 25

Bottom view

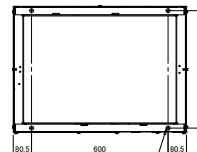

Foundation bolt type: 4x Ø17

Front view

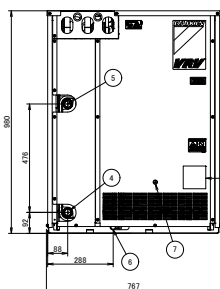

Right-side view

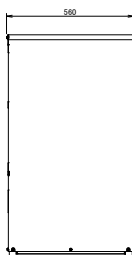

Rear view

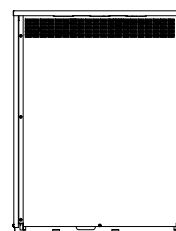

Table 1

Model	RWEYQ8T9		RWEYQ10T9		RWEYQ12T9		RWEYQ14T9	
	Heat pump	Heat recovery	Heat pump	Heat recovery	Heat pump	Heat recovery	Heat pump	Heat recovery
Liquid pipe	Ø 9.5		Ø 9.5		Ø 12.7		Ø 12.7	
Suction pipe	Ø 19.1	Ø 15.9	Ø 22.2	Ø 19.1	Ø 28.6	Ø 19.1	Ø 28.6	Ø 22.2
Gas pipe (high/low pressure)	Ø 19.1	Ø 15.9	Ø 22.2	Ø 19.1	Ø 28.6	Ø 19.1	Ø 28.6	Ø 22.2

Notes

1. The grounding terminal is located in the switch box.
2. The pipe connections are brazed connections.
3. In case of a heat pump, the suction pipe is not used.

2D108932A

7 Centre of gravity

7 - 1 Centre of Gravity

RWEYQ-T9

Front view

Right-side view

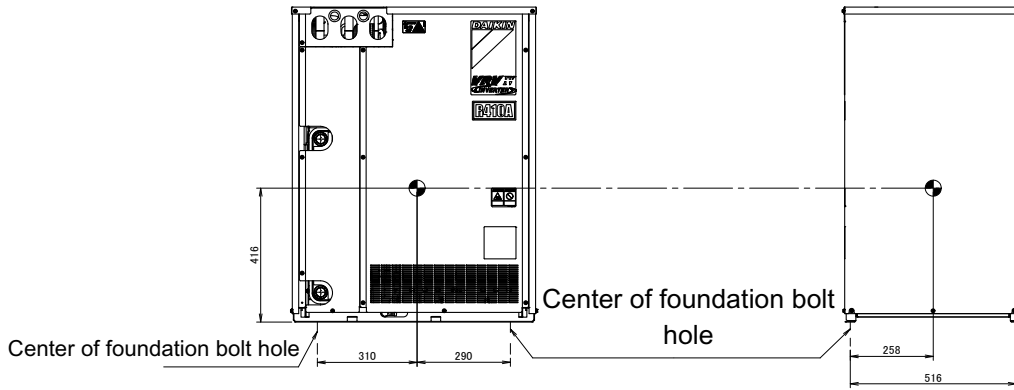

3D108934

8 Piping diagrams

8 - 1 Piping Diagrams

RWEYQ-T9

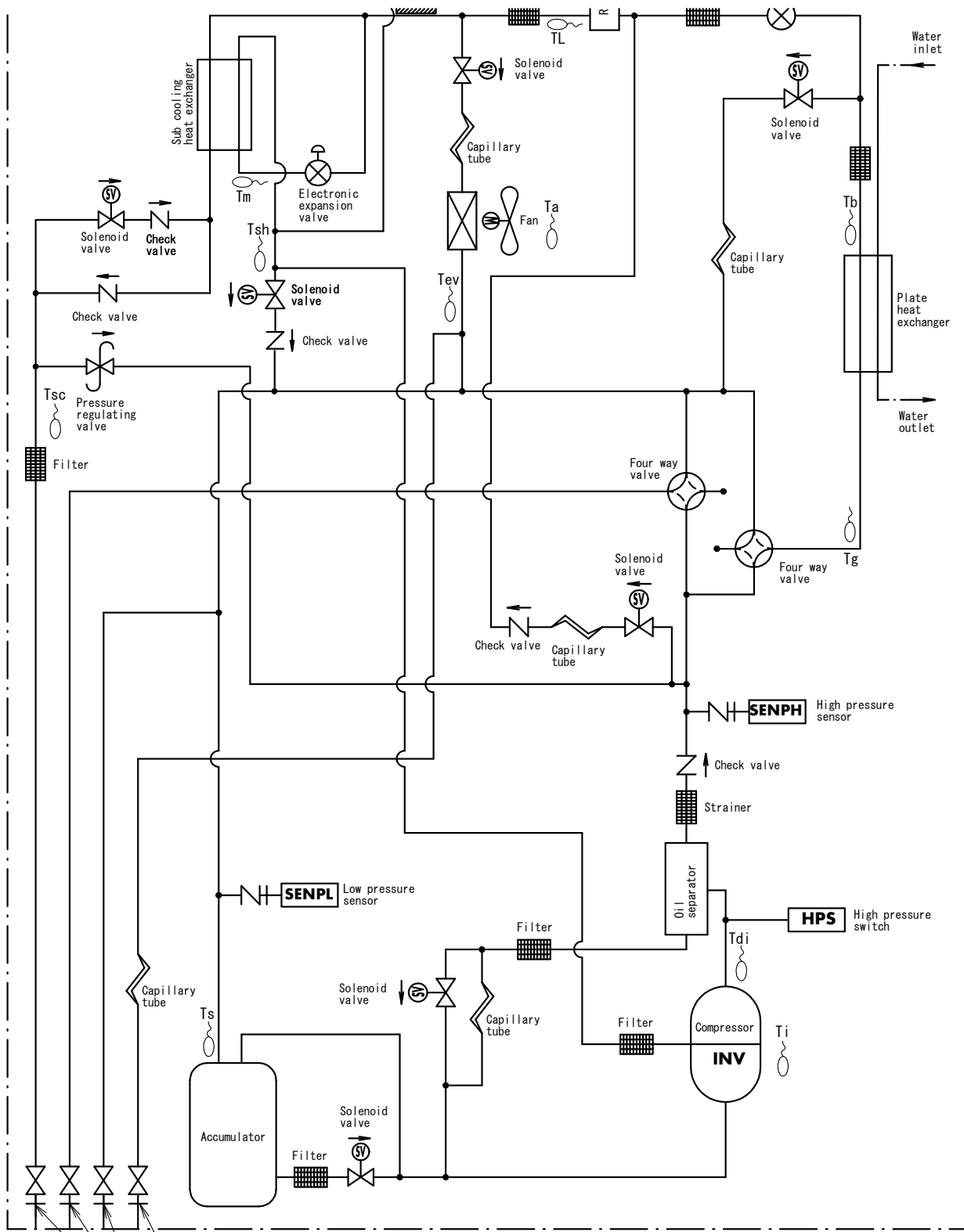

Charge port

Stop valve (with service port on on-site piping size $\varnothing 5/16''$ flare connection)





4D108945A

9 Wiring diagrams

9 - 1 Wiring Diagrams - Three Phase

RWEYQ-T9

NOTES to go through before starting the unit

- X1M : Main terminal
- : Earth wiring
- 15 : Wire number 15
- : Field wire
-  : Field cable
- **/12.2 : Connection ** continues on page 12 column 2
- ① : Several wiring possibilities
-  : Option
-  : Wiring depending on model
-  : Not mounted in switch box
-  : PCB

POSITION IN SWITCH BOX

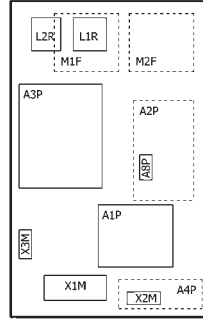

1. Refer to the installation or service manual on how to use BS1 ~ BS3 push buttons and DS1 ~ DS2 DIP switches.
2. Do not operate the unit by short-circuiting protection device (S1PH).
3. For connection to indoor-outdoor transmission F1-F2 wiring, outdoor - outdoor transmission F1-F2, refer to "service manual".

4D108928A

RWEYQ-T9

LEGEND

Part n°	Description
A1P	main PCB
A2P	noise filter PCB
A3P	inverter PCB
A4P	SUB PCB
A8P	adapter PCB
A9P	* cool/heat selector PCB
BS* (A1P)	push buttons (mode, set, return)
C* (A3P)	capacitor
DS* (A1P)	dipswitch
E1HC	crankcase heater
F1S (A2P)	surge arrester
F1U (A4P)	fuse T 3,15A 250V
F401U (A2P)	fuse T 6,3A 250V
F402U (A2P)	fuse T 6,3A 250V
F403U (A2P)	fuse T 6,3A 250V
F410U (A2P)	fuse T 63A 600V
F411U (A2P)	fuse T 63A 600V
F412U (A2P)	fuse T 63A 600V
F*U (A1P)	fuse T 3,15A 250V
HAP (A1P)	running LED (service monitor-green)
K1M (A3P)	magnetic contactor
K*R (A*P)	magnetic relay
L*R	reactor
M1C	motor (compressor)
M*F	motor (fan)
PS (A1P)	power supply

Q1DI	#	earth leakage circuit breaker
Q1RP (A1P)		phase reversal detect circuit
R* (A3P)		resistor
R*T		thermistor
R*V (A2P)		varistor
S1NPH		high pressure sensor
S1NPL		low pressure sensor
S1PH		high pressure switch (disch)
S1S		air control switch
S2S		cool / heat switch
S3S		interlock switch
SEG* (A1P)		7-segment display
T1A		leakage current detection sensor
V1R (A3P)		IGBT power module
V2R (A3P)		diode module
X66A		connector (remote switching cool/heat selector)
X*A		PCB connector
X*M		terminal strip
X*M (A*P)		terminal strip on PCB
X*Y		connector
Y*E		electronic expansion valve
Y*S		solenoid valve
Y*C		noise filter (ferrit core)
Z*F		noise filter

* : optional
: field supply

4D108928A

9 Wiring diagrams

9 - 1 Wiring Diagrams - Three Phase

9

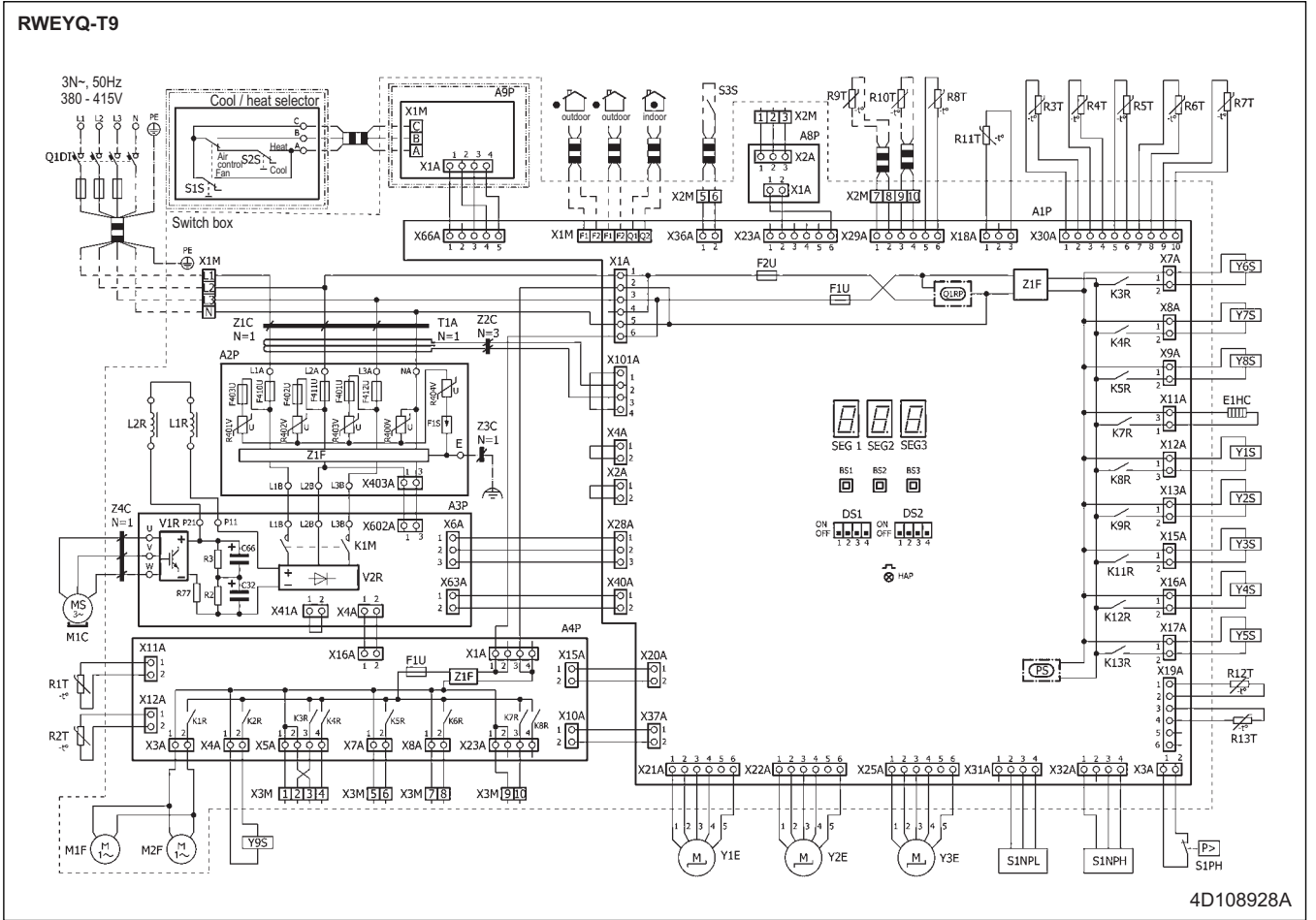

10 External connection diagrams

10 - 1 External Connection Diagrams

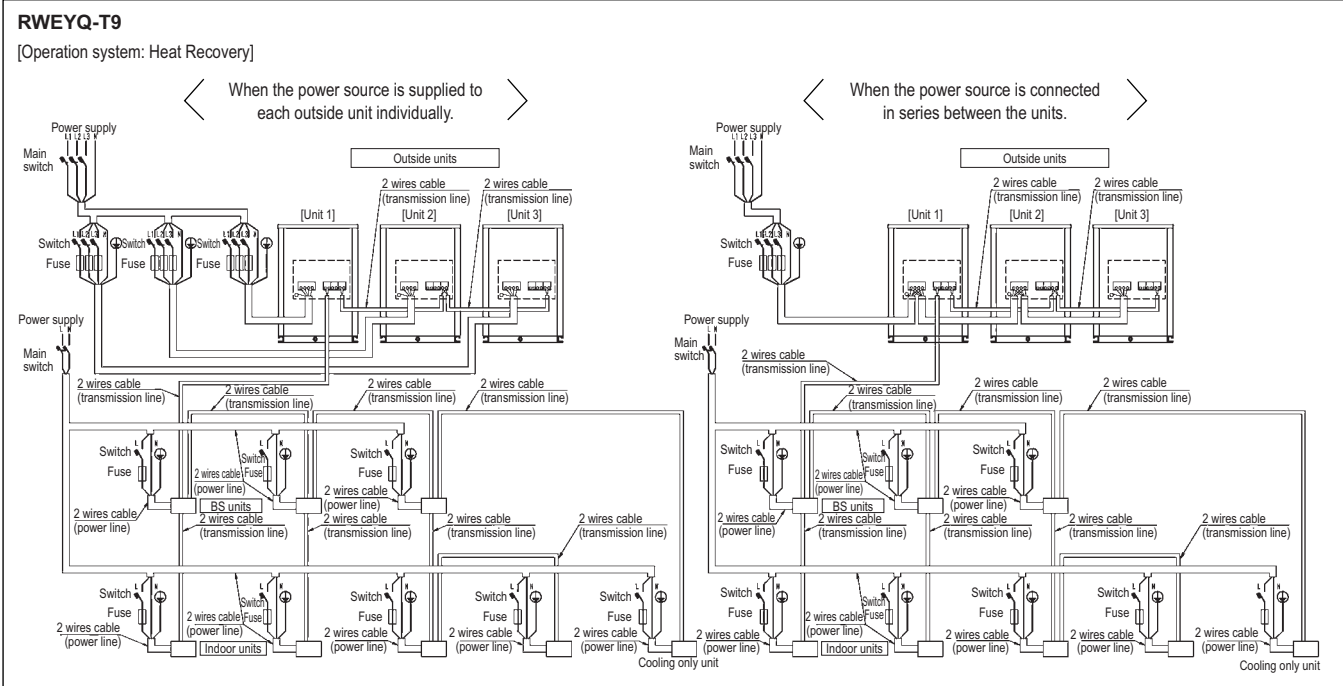

- NOTES**
1. All wiring, components and materials to be procured on the site must comply with the applicable local and national codes.
 2. Use copper conductors only.
 3. As for details, see wiring diagrams.
 4. Install circuit breaker for safety.
 5. All field wiring and components must be provided by licensed electrician.
 6. Unit shall be grounded in compliance with the applicable local and national codes.
 7. Wiring shown are general points-of-connection guides only and are not intended for or to include all details for a specific installation.
 8. Be sure to install the switch and the fuse to the power line of each equipment.
 9. Install the main switch that can interrupt all the power sources in an integrated manner because this system consists of the equipment utilizing the multiple power sources.
 10. If there exists the possibility of reversed phase, lose phase, momentary blackout or the power goes on and off while the product is operating, attach a reversed phase protection circuit locally.
Running the product in reversed phase may break the compressor and other parts.
- 3D048823F

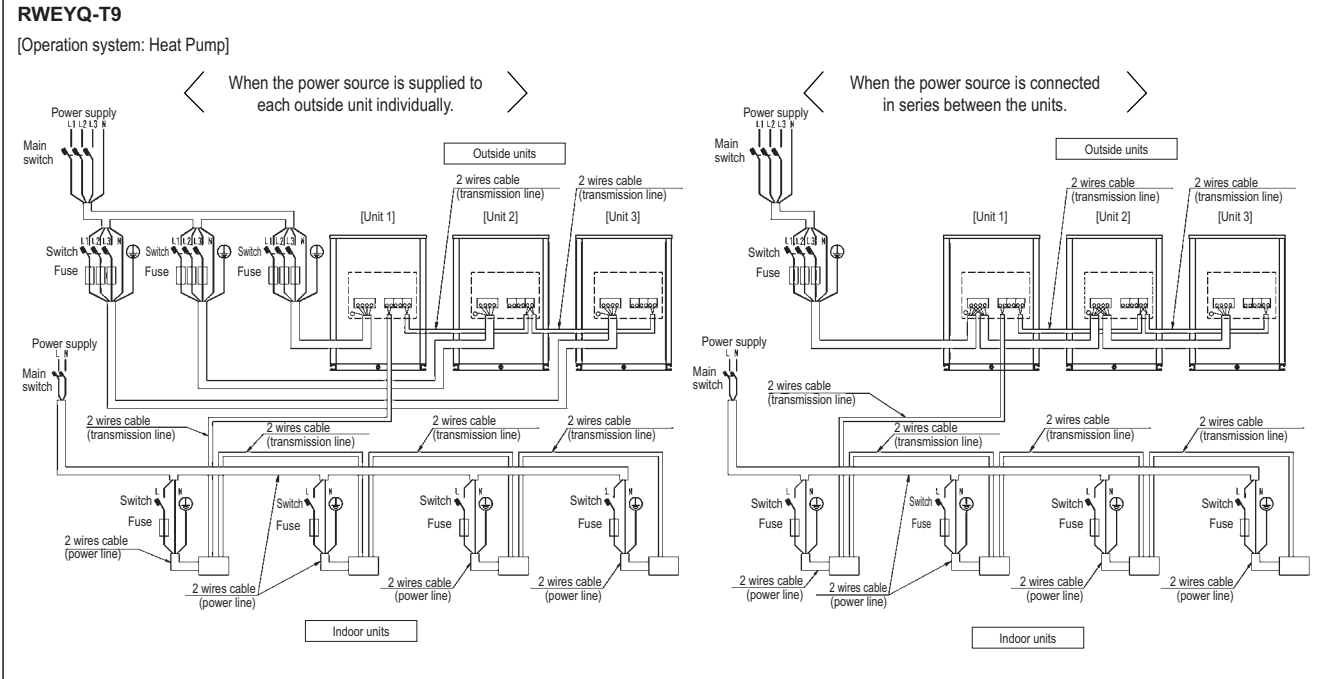

- NOTES**
1. All wiring, components and materials to be procured on the site must comply with the applicable local and national codes.
 2. Use copper conductors only.
 3. As for details, see wiring diagrams.
 4. Install circuit breaker for safety.
 5. All field wiring and components must be provided by licensed electrician.
 6. Unit shall be grounded in compliance with the applicable local and national codes.
 7. Wiring shown are general points-of-connection guides only and are not intended for or to include all details for a specific installation.
 8. Be sure to install the switch and the fuse to the power line of each equipment.
 9. Install the main switch that can interrupt all the power sources in an integrated manner because this system consists of the equipment utilizing the multiple power sources.
 10. If there exists the possibility of reversed phase, lose phase, momentary blackout or the power goes on and off while the product is operating, attach a reversed phase protection circuit locally.
Running the product in reversed phase may break the compressor and other parts.
- 3D048824F

11 Sound data

11 - 1 Sound Power Spectrum

11

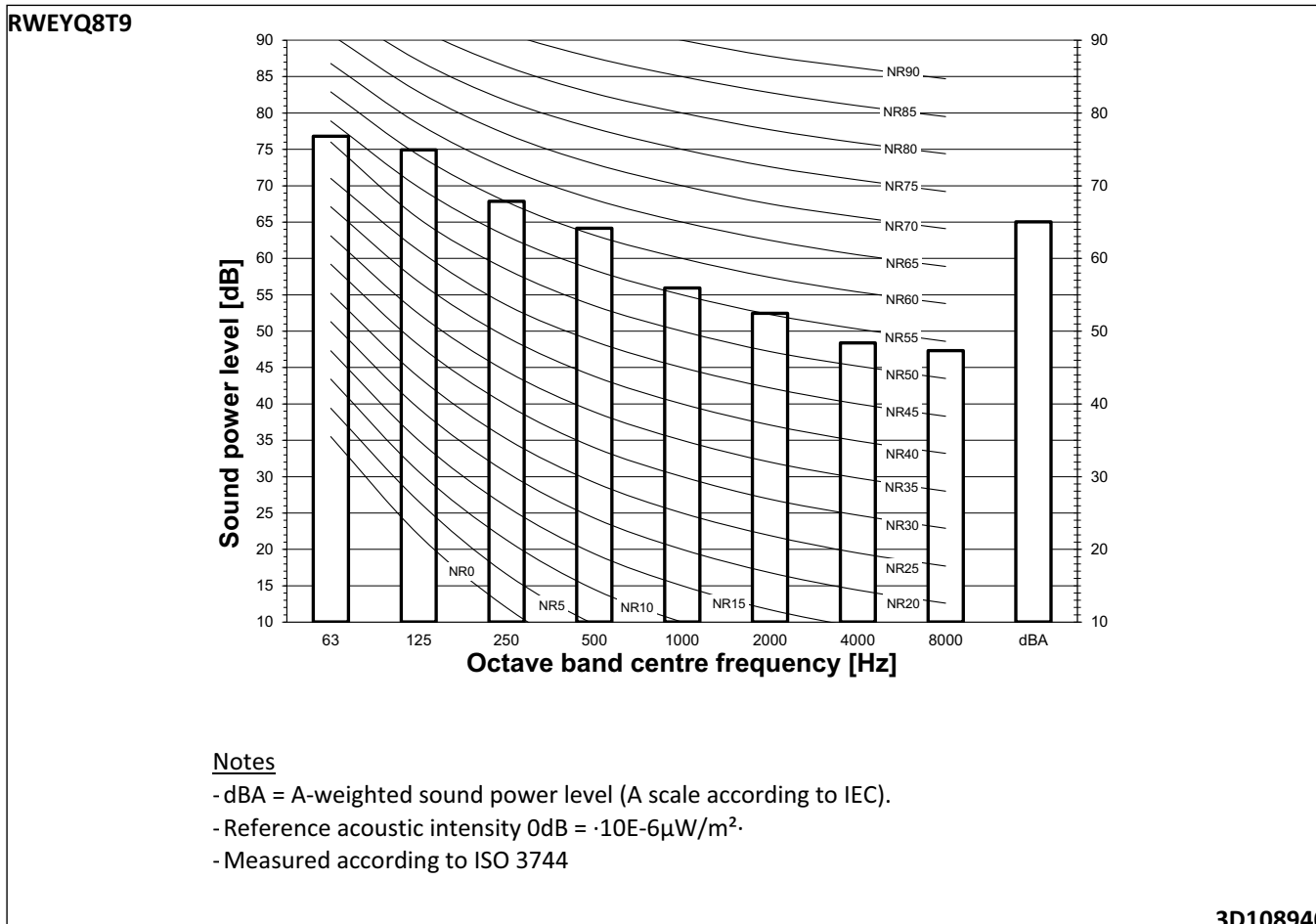

3D108940

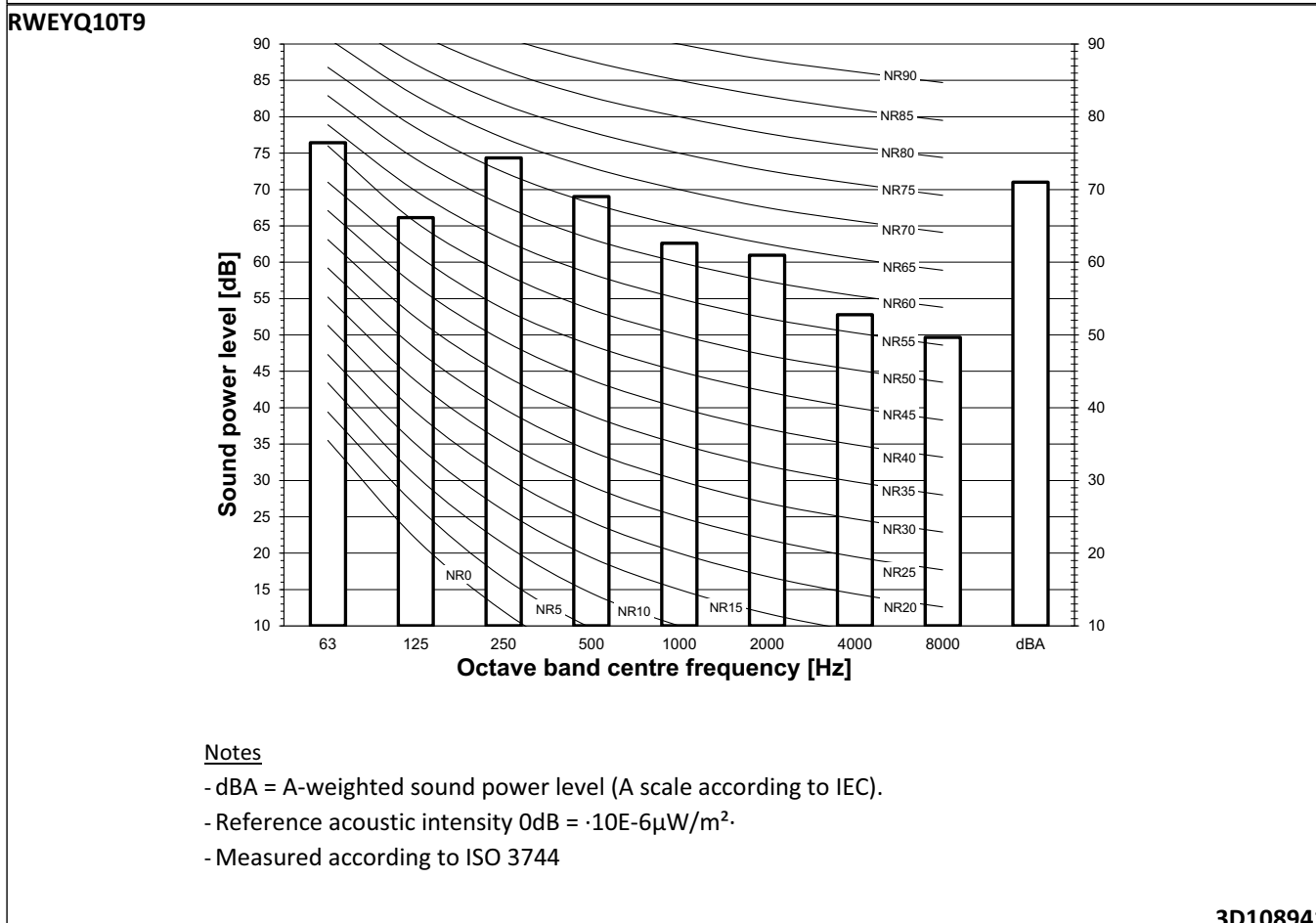

3D108941

11 Sound data

11 - 1 Sound Power Spectrum

RWEYQ12T9

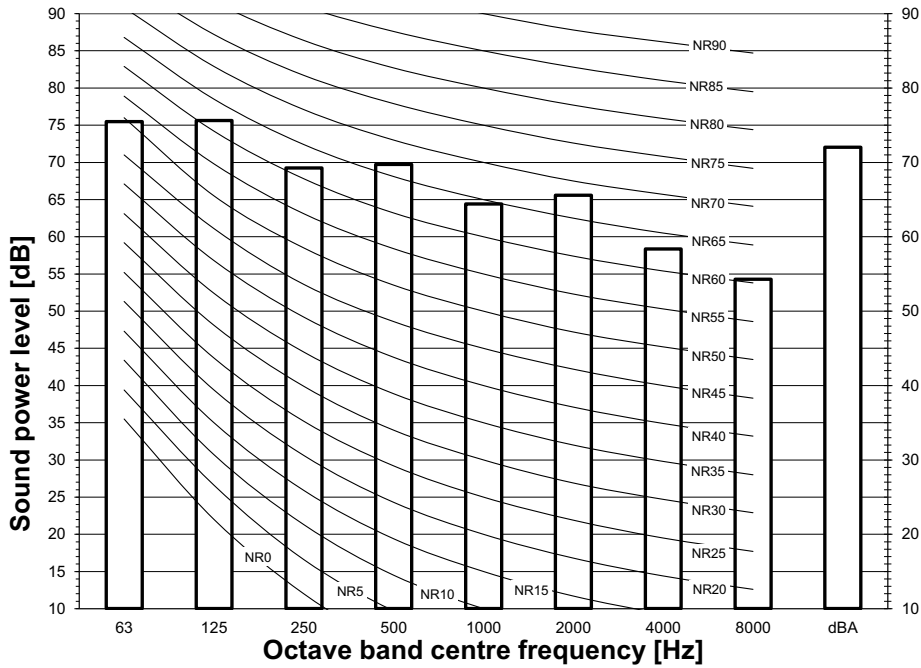

Notes

- dBA = A-weighted sound power level (A scale according to IEC).
- Reference acoustic intensity 0dB = $\cdot 10E-6\mu W/m^2$.
- Measured according to ISO 3744

3D108942

RWEYQ14T9

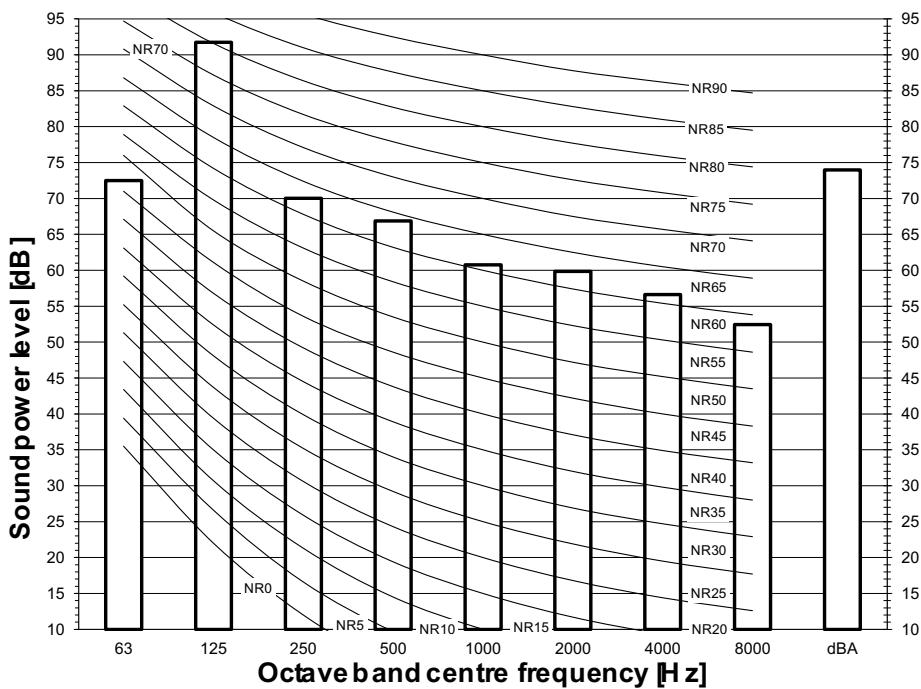

Notes

- dBA = A-weighted sound power level (A scale according to IEC).
- Reference acoustic intensity 0dB = $\cdot 10E-6\mu W/m^2$.
- Measured according to ISO 3744

3D108943A

11 Sound data

11 - 2 Sound Pressure Spectrum

11

RWEYQ8T9

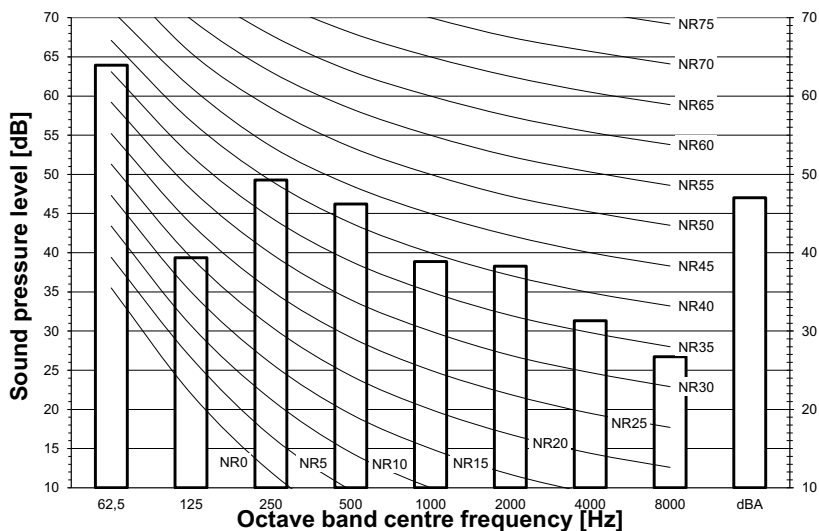

Data is valid at free field condition.
 Data is valid at nominal operation condition.
 dBA = A-weighted sound pressure level (A scale according to IEC).
 Reference acoustic pressure 0 dB = 20 µPa

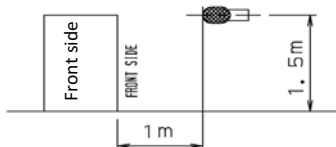

3D108936

RWEYQ10T9

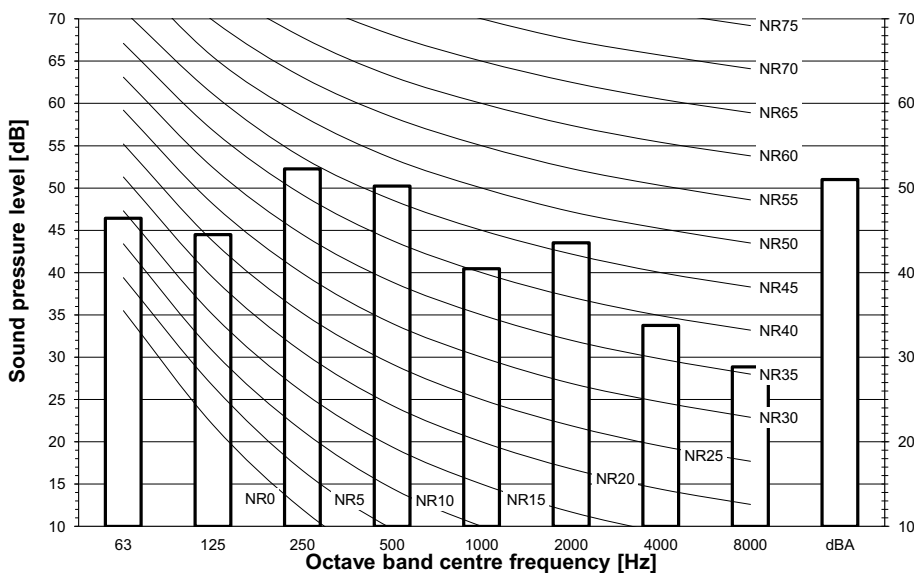

Notes

- Data is valid at free field condition.
- Data is valid at nominal operation condition.
- dBA = A-weighted sound pressure level (A scale according to IEC).
- Reference acoustic pressure 0 dB = 20 µPa

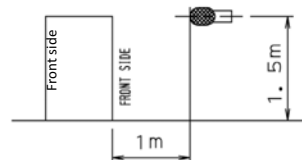

3D108937

11 Sound data

11 - 2 Sound Pressure Spectrum

RWEYQ12T9

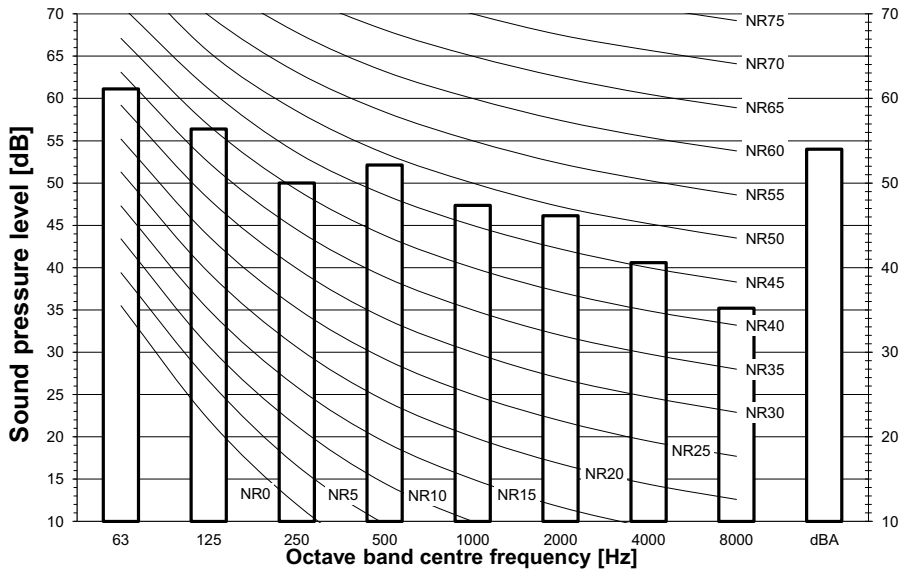

Notes

- Data is valid at free field condition.
- Data is valid at nominal operation condition.
- dBA = A-weighted sound pressure level (A scale according to IEC).
- Reference acoustic pressure 0 dB = 20 µPa

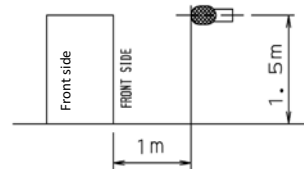

3D108938

RWEYQ14T9

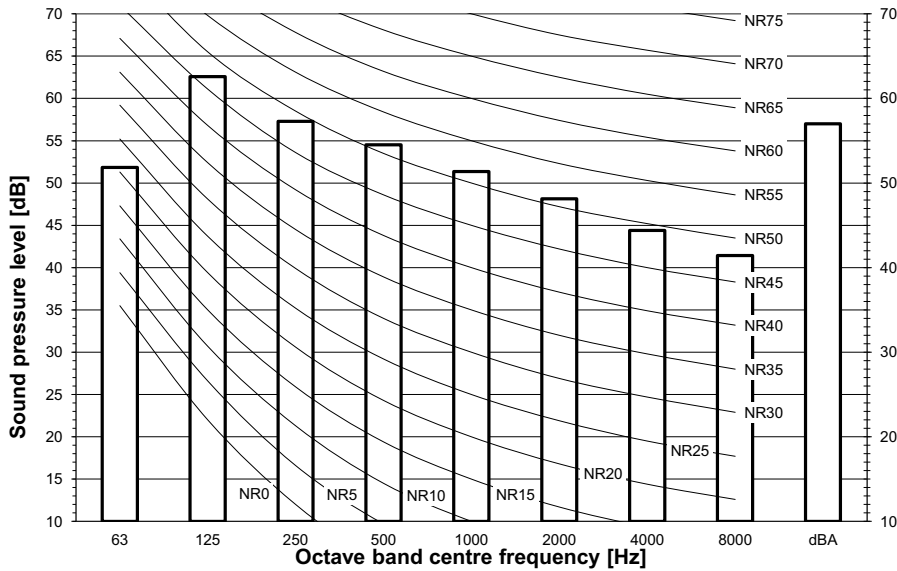

Notes

- Data is valid at free field condition.
- Data is valid at nominal operation condition.
- dBA = A-weighted sound pressure level (A scale according to IEC).
- Reference acoustic pressure 0 dB = 20 µPa

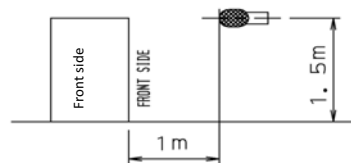

3D108939

12 Installation

12 - 1 Installation Method

12

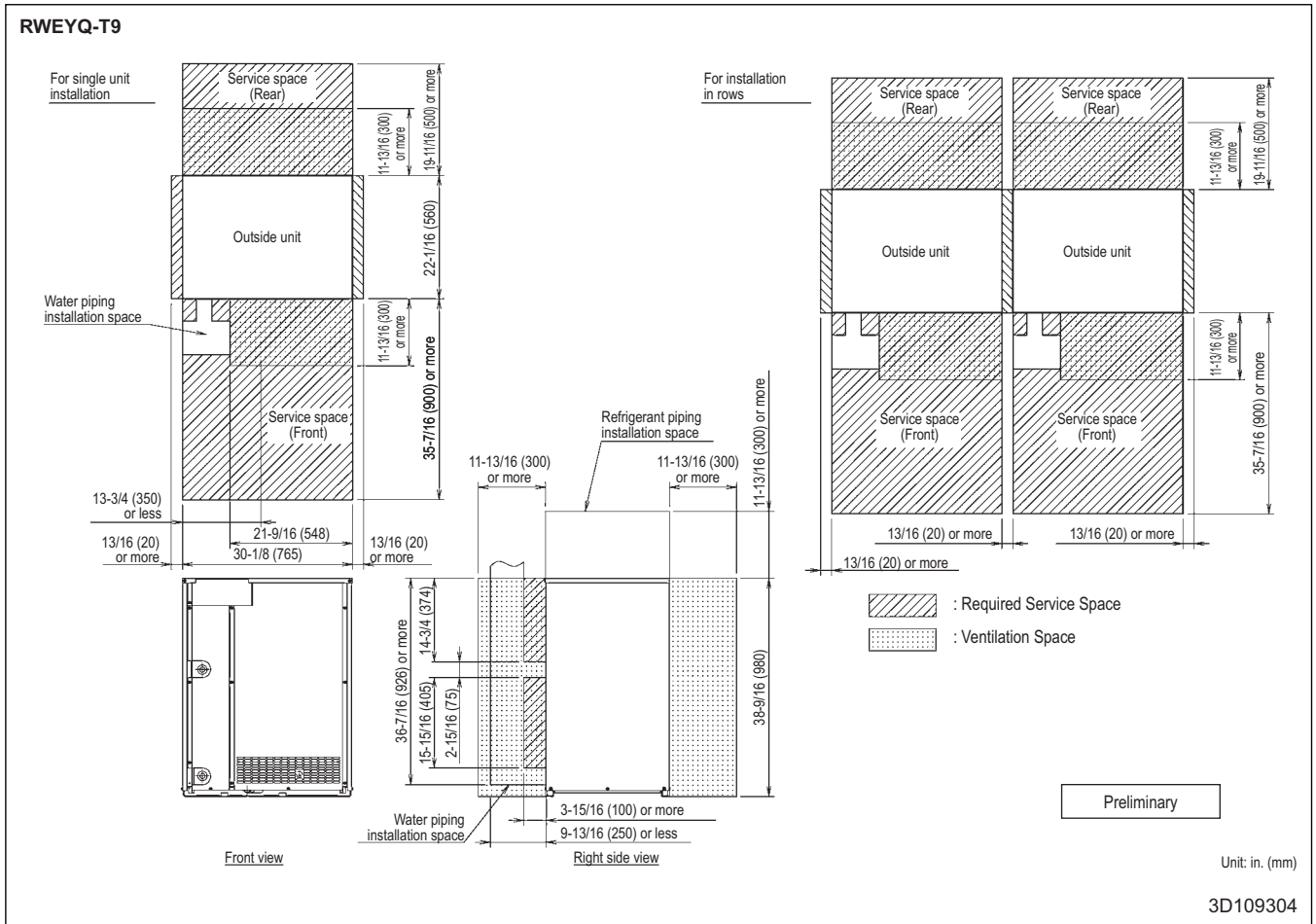

12 Installation

12 - 2 Refrigerant Pipe Selection

RWEYQ-T9

VRV4 Watercooled Field Piping Restrictions
Heat pump
Piping restrictions 1/3

		Maximum piping length			Maximum height difference			Total piping length	
		Longest pipe (A+[B,G,E,J]) Actual / (Equivalent) ⁽⁶⁾	After first branch (B,G,E,J) Actual	After first branch (for multi-D) Actual / (Equivalent)	Indoor-to-outdoor (H1) Outdoor above indoor / (indoor above outdoor)	Indoor-to-indoor (H2)	Outdoor-to-outdoor (H3)		
VRV DX indoor units only		165/(190)m	40m ⁽¹⁾	10/(13)m	50/(40)m ⁽³⁾	30m	5m	300m	
		120/(140)m	40m ⁽¹⁾	10/(13)m	50/(40)m ⁽³⁾	30m	5m	500m	
Hydrobox connection		120/(140)m ⁽⁵⁾	40m	10/(13)m	50/(40)m	15m	5m	300m	
RA connection		100/(120)m	40m ⁽²⁾	-	50/(40)m	15m	-	250m	
AHU connection		Pair ⁽⁶⁾	50/(55)m ⁽⁴⁾	-	50/(40)m	-	-	-	
		Multi	120/(140)m	40m	10/(13)m	50/(40)m	15m	5m	300m
		Mix ⁽⁷⁾	120/(140)m	40m	10/(13)m	50/(40)m	15m	5m	300m

Remark

Only available for single model configuration.

- (1) If all conditions below are met, the limitation can be extended up to 90 m
 - a. The piping length between all indoor units and the nearest branch kit is ≤ 40m.
 - b. It is necessary to increase the size of the gas and liquid piping.
If the increased pipe size is larger than the pipe size of the main pipe, also increase the size of the main pipe.
 - c. When the piping size is increased, the piping length has to be counted as double.
The total piping length has to be within limitations.
 - d. The piping length difference between the nearest indoor unit from the first branch to the outdoor unit and the farthest indoor unit to the outdoor unit is ≤ 40m.
- (2) If the piping length between the first branch and the BP box or VRV indoor unit is more than 20m, increase the length of the gas and liquid piping between the first branch and the BP box or VRV indoor unit.
- (3) An extension to up to 90 m is possible without an additional option kit. Respect the following conditions:
 - > If the outdoor units are positioned higher than the indoor units:
 - a. Size up the liquid piping
 - b. A dedicated setting on the outdoor unit is required.
 - > If the outdoor units are positioned lower than the indoor units:
 - a. 40~60m Minimum connection ratio: 80%
 - 60~65m Minimum connection ratio: 90%
 - 65~80m Minimum connection ratio: 100%
 - 80~90m Minimum connection ratio: 110%
 - b. Size up the liquid piping
A dedicated setting on the outdoor unit is required.
- (4) The allowable minimum length is 5 m.
- (5) If the equivalent piping length between is > 90m, size up the main liquid and gas piping.
- (6) Multiple air handling units (AHU)(EKEXV + EKEQ kits).
- (7) Mix of AHU units and VRV DX indoor

3D108948

12 Installation

12 - 2 Refrigerant Pipe Selection

12

RWEYQ-T9

VRV4 Watercooled Field Piping Restrictions

Heat pump
Piping restrictions 2/3

Outdoor

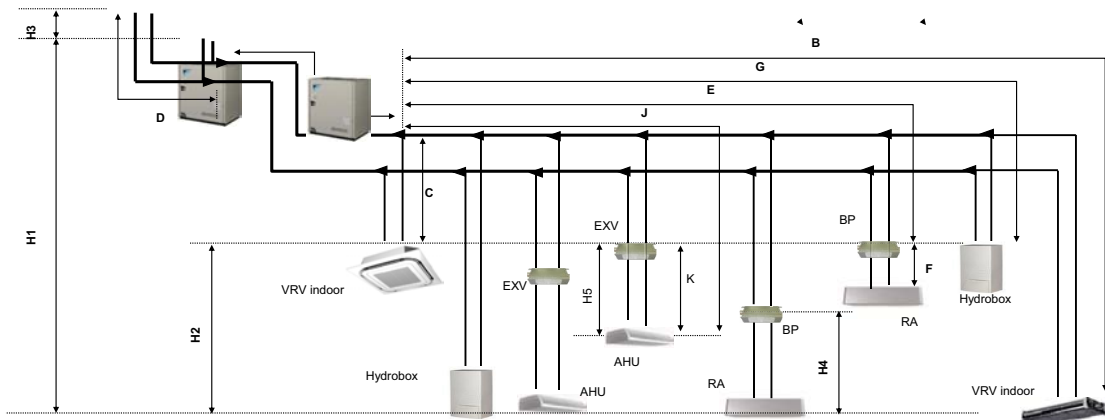

Remark

- (1) Schematic indication
Illustrations may differ from the actual appearance of the unit.
- (2) This is only to illustrate piping length limitations.
Combination of indoor unit types is not allowed.
Refer to combination table 3D079543 for details about the allowed combinations.

		Allowed piping length		Maximum height difference	
		BP to RA	EXV to AHU	BP to RA	EXV to AHU
		(F)	(K)	(H4)	(H5)
RA connection		2~15m	-	5m	-
AHU connection	Pair⁽¹⁾	-	≤5m	-	5m
	Multi	-	≤5m	-	5m
	Mix	-	≤5m	-	5m

Remark

- (1) Multiple air handling units (AHU)(EKEXV + EKEQ kits).
- (2) Mix of AHU units and VRV DX indoor

12 Installation

12 - 2 Refrigerant Pipe Selection

RWEYQ-T9

VRV4 Watercooled Field Piping Restrictions
Heat pump
Piping restrictions 3/3

System pattern		Total		Allowed capacity			
				VRV DX indoor unit	RA DX indoor unit	Hydrobox unit	Air handling unit (AHU)
Allowed connection ratio (CR)		Capacity	Indoor unit quantity (VRV, RA, AHU, Hydrobox)				
Other combinations are not allowed.							
VRV DX indoor units only	Including FXZQ15 or FXAQ15	50~125%	Max.64	50~125%	-	-	-
	Including FXFQ20 or FXFQ25	50~130%	Max.64	50~130%	-	-	-
	Only FXDQ, FXSQ and FXAQ20~63	50~150%	Max.64	50~150%	-	-	-
	All other models (single system)	50~150%	Max.64	50~150%			
	All other models (multi system)	50~130%	Max.64	50~130%	-	-	-
VRV DX indoor unit + RA DX		80~130%	Max.32 ⁽¹⁾	0~130%	0~130%	-	-
RA DX indoor units only		80~130%	Max.32 ⁽¹⁾	-	80~130%	-	-
VRV DX indoor unit + LT hydrobox		50~130%	Max.32	50~130%	-	0~80%	-
VRV DX indoor unit + AHU		50~110% ⁽³⁾	Max.64 ⁽²⁾	50~110%	-	-	0~110%
AHU only		90~110% ⁽³⁾	Max.64 ⁽²⁾	-	-	-	90~110%
Pair + multi							

Remark

- (1) There is no restriction on the number of connectable BP boxes.
- (2) For connection with AHU
EKEXV kits are also considered indoor units.
- (3) Restrictions regarding the air handling unit capacity
- (4) Pair AHU = system with 1 air handling unit connected to one outdoor unit
Multi AHU = system with multiple air handling units connected to one outdoor unit

About ventilation applications

- I. FXMQ_MF units are considered air handling units, following air handling unit limitations.
Maximum connection ratio when combined with VRV DX indoor units: <30%.
Maximum connection ratio when only air handling units are connected: <100%.
For information on the operation range, refer to the documentation of the FXMQ_MF unit.
- II. Biddle air curtains are considered air handling units, following air handling unit limitations:
For information on the operation range, refer to the documentation of the Biddle unit.
- III. [EKEXV + EKEQ] units combined with an air handling unit are considered air handling units, following air handling unit limitations.
For information on the operation range, refer to the documentation of the EKEXV-EKEQ unit.
- IV. VKM units are considered to be regular VRV DX indoor units.
For information on the operation range, refer to the documentation of the VKM unit.
- V. Because there is no refrigerant connection with the outdoor unit (only communication F1/F2), VAM units do not have connection limitations.
However, since there is communication via F1/F2, count them as regular indoor unit when calculating the maximum allowed number of connectable indoor units.

12 Installation

12 - 2 Refrigerant Pipe Selection

RWEYQ-T9

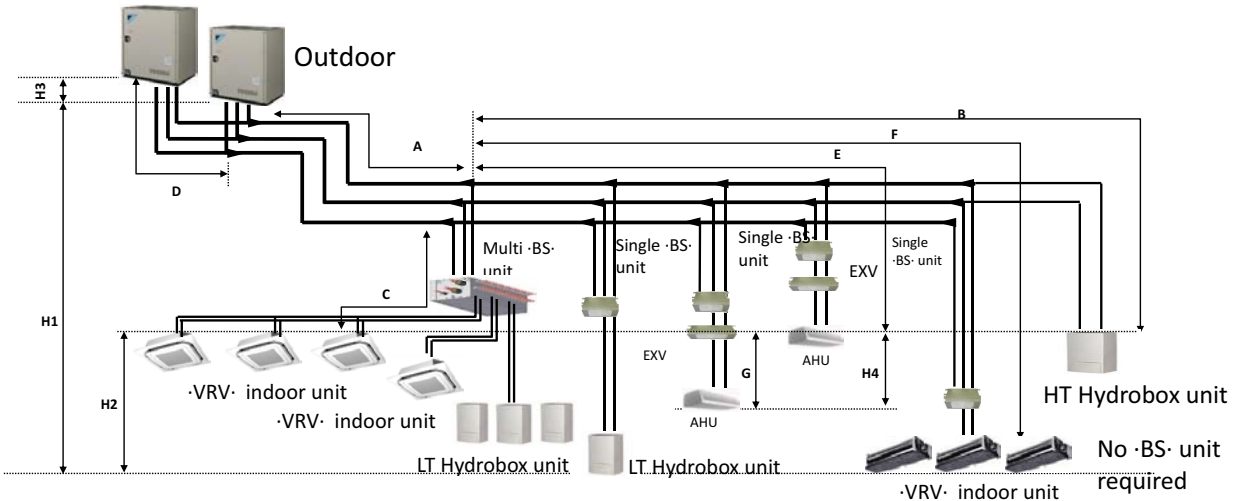

3D108949

RWEYQ-T9

VRV4 Watercooled Field Piping Restrictions Heat recovery Piping restrictions

		Total		Allowed capacity			
		Capacity	Maximum indoor unit quantity	VRV indoor unit	VRV indoor unit without Cooling only	Hydrobox unit	Air handling unit (AHU)
VRV indoor units only	Including FXZQ15 or FXAQ15	50 ~ 125 %	64	50 ~ 125 %	0 ~ 50 %	Not allowed	Not allowed
	Including FXFQ20 or FXFQ25	50 ~ 130 %	64	50 ~ 130 %	0 ~ 50 %	Not allowed	Not allowed
	Only FXDQ, FXSQ and FXAQ20~63	50 ~ 150 %	64	50 ~ 150 %	0 ~ 50 %	Not allowed	Not allowed
	All other models (single system)	50 ~ 150 %	64	50 ~ 150 %	0 ~ 50 %	Not allowed	Not allowed
	All other models (multi system)	50 ~ 130 %	64	50 ~ 130 %	0 ~ 50 %	Not allowed	Not allowed
VRV indoor unit + Hydrobox		50 ~ 200 % (*2)	32	50 ~ 110 %	0 ~ 50 %	0 ~ 100 %	Not allowed
VRV indoor unit + AHUs		50 ~ 110 %	64	50 ~ 110 %	0 ~ 50 %	Not allowed	0 ~ 60 %

Notes

1. Excluding BS-units and including EXV-kits.
2. The total capacity of DX indoor units and LT Hydrobox units is 130%.
3. Other combinations than mentioned in this combination table are prohibited.
4. Cooling-only VRV indoor units cannot be combined with HT Hydrobox units.

Amount of units connectable to a BS-unit

	BS1Q10 (*6)	BS1Q16 (*6)	BS1Q25 (*6)	Multi-BS per branch (*6)	Multi-BS when 2 branches are combined (*5) (*6)
VRV indoor unit	Maximum 6-units	Maximum 8-units	Maximum 8-units	Maximum 5-units	Maximum 5-units
Air handling unit (AHU)	Maximum 100-class	Maximum 160-class	Maximum 250-class	Maximum 140-class	Maximum 250-class
LT Hydrobox unit	= 1 x HXY080	= Maximum 2 x HXY080- Or maximum 1 x HXY125	= Maximum 3 x HXY080- Or maximum 2 x HXY125- Or HXY080 + HXY125	= Maximum 1 x HXY080- Or maximum 1 x HXY125-	= Maximum 3 x HXY080- Or maximum 2 x HXY125- Or HXY080 + HXY125

Notes

5. When combining 2-branches, the maximum piping length between the BS-unit and the indoor unit is ≤ 20m. If the length of this piping is > 20m, increase the size of the liquid pipe.
6. When using Hydrobox units, do not combine them with other types of units.

3D108949

12 Installation

12 - 2 Refrigerant Pipe Selection

RWEYQ-T9

VRV4 Watercooled Field Piping Restrictions

Heat recovery

Piping restrictions

	Maximum piping length			Maximum height difference			Total piping length
	Longest pipe from the outdoor unit or the last multi-outdoor piping branch	Longest pipe after first branch	Longest pipe from the outdoor unit to the last multi-outdoor piping branch	Indoor-to-outdoor	Indoor-to-indoor	Outdoor-to-outdoor	Piping length
	Actual / Equivalent	Actual	Actual / Equivalent	Outdoor unit higher than indoor unit / Indoor unit higher than outdoor unit			
	Maximum: -(A+B, A+C, A+E, A+F)-	Maximum: -(B,C,E,F)-	Maximum: -(D)-	Maximum: -(H1)-	Maximum: -(H2)-	Maximum: -(H3)-	
-VRV- indoor units only	165/190 m (*3)	40 m (*1)	10/13 m	50/40 m (*2)	30m	5 m	300 m
	120/140m (*3)	40 m (*1)		50/40 m (*2)	30m		500 m
Hydrobox unit	120/140m (*3)	40 m		50/40 m	15m		300 m
AHU (*4)	120/140m (*3)	40 m		50/40 m	15m		300 m

	Maximum piping length	Maximum height difference
	EXV --> AHU: G	EXV --> AHU: H4
AHU (*4)	5 m	5 m

Notes

1. If all conditions below are met, the limitation can be extended up to 90 m
 - 1.1 In case of -BS1Q- units, the piping length between all indoor units and the nearest branch kit is ≤ -40-m.
In case of multi BS units, the piping length between all indoor units and the multi BS unit is ≤ -40-m.
It is required to size up the liquid piping between the first branch kit and the last.
In contrast to multi BS units, -BS1Q- units are not considered branch kits.
If the increased pipe size is larger than the pipe size of the main pipe, also increase the size of the main pipe.
When the piping size is increased, the piping length has to be counted as double.
The total piping length has to be within limitations.
The piping length difference between the nearest indoor unit to the outdoor unit and the farthest indoor unit to the outdoor unit is ≤ -40-m.
2. If all conditions below are met, the limitation can be extended up to 90 m
 - 2.1 If the outdoor units are positioned higher than the indoor units:
 - 2.1.1 Minimum connection ratio: -80%-
 - 2.1.2 Size up the liquid piping
 - 2.1.3 Outdoor unit setting
For more information, refer to the service manual.
 - 2.2 If the outdoor units are positioned lower than the indoor units:
 - 2.2.1 No technical cooling
 - 2.2.2 Size up the liquid piping
 - 2.2.3 Outdoor unit setting
 - 2.2.4 Minimum connection ratio

-40~60m:	Minimum connection ratio: -80%-
-60~65m:	Minimum connection ratio: -90%-
-65~80m:	Minimum connection ratio: -100%-
-80~90m:	Minimum connection ratio: -110%-
3. If the equivalent piping is > -90-m, size up the main liquid piping.
4. Mix of -DX- units and -AHU's-
5. If there is no branch kit present in the system, the longest pipe after the multi -BS- unit has to be ≤ -40-m.

3D108949

13 Operation range

13 - 1 Operation Range

13

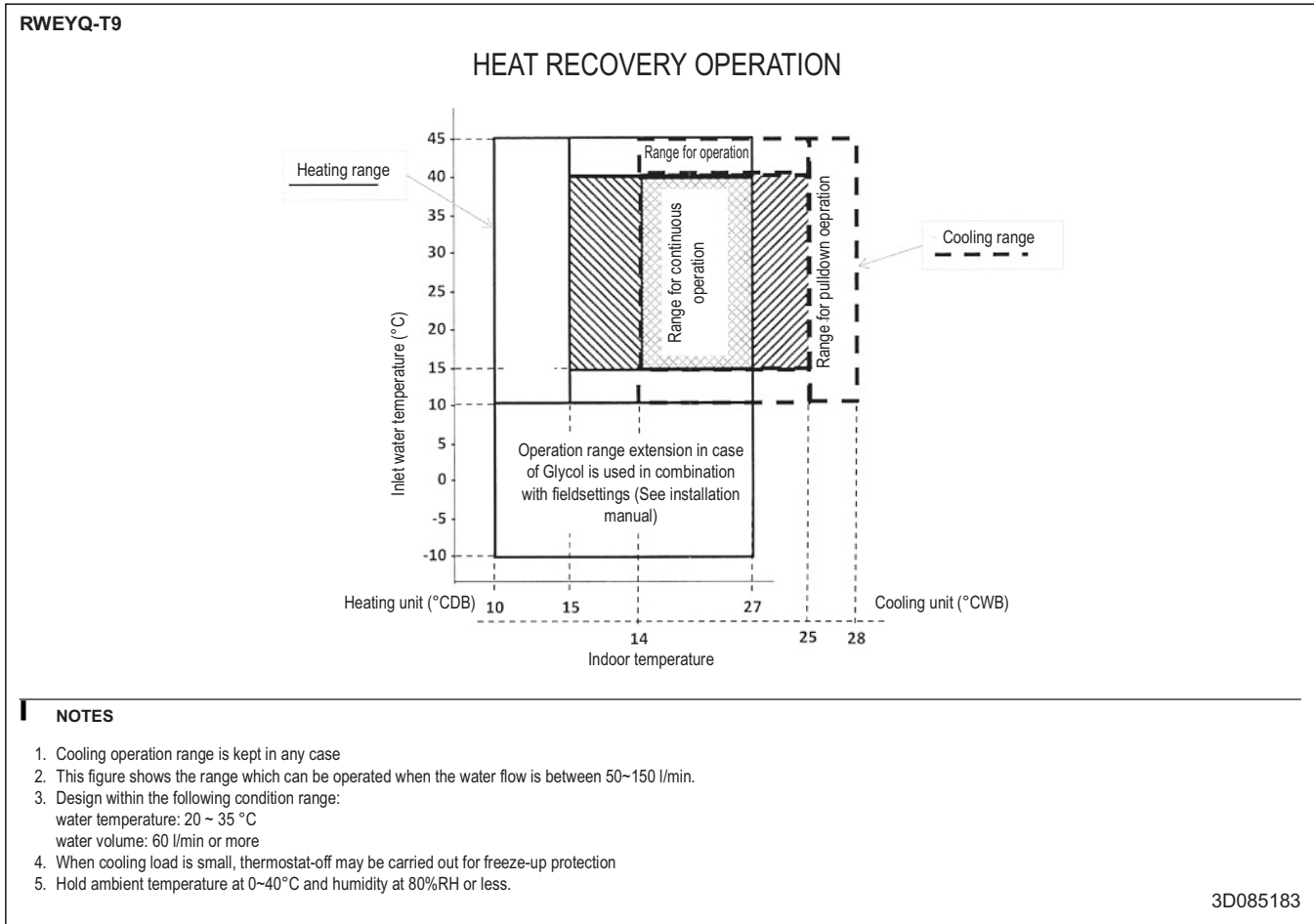
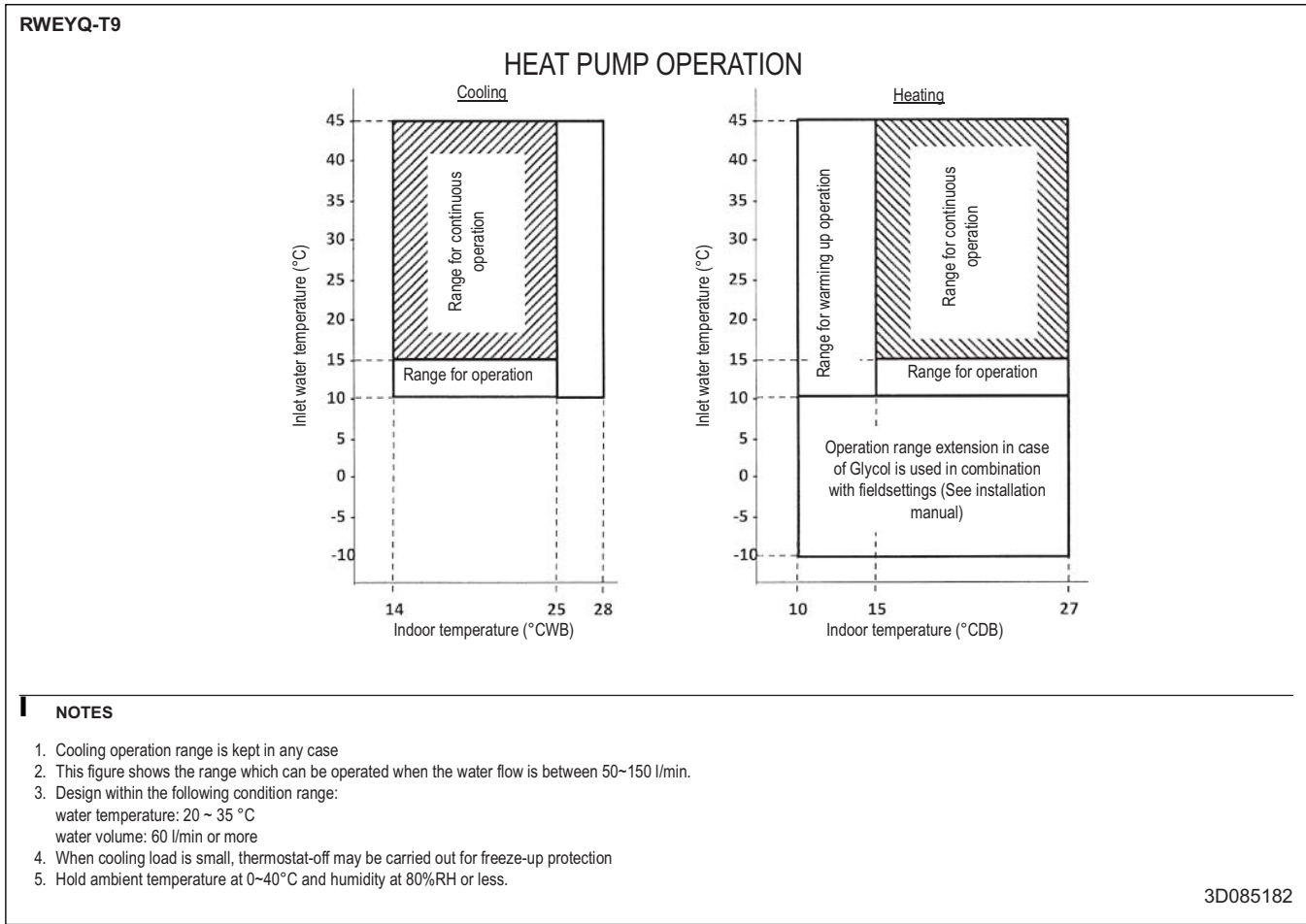



Daikin Europe N.V. Naamloze Vennootschap - Zandvoordestraat 300, B-8400 Oostende - Belgium - www.daikin.eu - BE 0412 120 336 - RPR Oostende

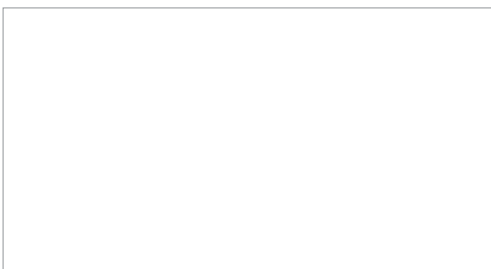

EEDEN18 10/17



The present leaflet is drawn up by way of information only and does not constitute an offer binding upon Daikin Europe N.V.. Daikin Europe N.V. has compiled the content of this leaflet to the best of its knowledge. No express or implied warranty is given for the completeness, accuracy, reliability or fitness for particular purpose of its content and the products and services presented therein. Specifications are subject to change without prior notice. Daikin Europe N.V. explicitly rejects any liability for any direct or indirect damage, in the broadest sense, arising from or related to the use and/or interpretation of this leaflet. All content is copyrighted by Daikin Europe N.V.