

Interruptores en Caja Moldeada



NM8, NM8S Interruptores Automáticos en Caja Moldeada

- * NM8 Electromecánicos
- * NM8S Electrónicos

Página 01



NM1 Interruptores Automáticos en Caja Moldeada

- * Fijos

Página 59

Códigos

Página 86

NM8, NM8S Interruptores Automáticos en Caja Moldeada

General	Página 01
Condiciones de servicio	Página 01
Composición de la referencia	Página 01
Despiece	Página 02
Datos técnicos	Página 05
Relés de protección	Página 12
Curvas	Página 15
Coeficientes de compensación de temperatura ambiente	Página 21
Sistemas de montaje	Página 22
Accesorios internos y externos	Página 29
Información técnica	Página 35
- Función de aislamiento	Página 35
- Limitación de corriente	Página 35
- Pérdida de potencia	Página 37
- Influencia de la temperatura	Página 38
- Protección en cascada	Página 38
- Selectividad	Página 47
- Protección de motores	Página 57



NMB, NMBS
Interruptores Automáticos en Caja Moldeada

1. General

- 1.1 Normativa: IEC, VDE, DIN, IEC, GOST, IEC, IEC, IEC, CEI;
- 1.2 Tensión nominal: 230-690Vca - 50/60Hz;
- 1.3 Tensión de servicio: 250-500Vcc - 16A - 125A
- 1.4 Corrientes nominales: 16, 20, 25, 32, 40, 50, 63, 80, 100, 125
- 1.5 Corrientes nominales: 100, 250, 400, 630, 800
- 1.6 Normas: IEC 60947-2
- 1.7 Mecanismo: vertical y horizontal
- 1.8 Normas: UNE-EN 60947-2
- 1.9 Aprobación: Del NORXSE VERITAS para usos marinos

2. Condiciones de servicio

- 2.1 La temperatura ambiente máxima no debe exceder +35°C.
- 2.2 El valor medio de la temperatura ambiente no debe exceder +35°C para interruptores con protección magnotérmica.
- 2.3 La temperatura ambiente mínima no debe ser inferior a -40°C para interruptores con protección térmica.
- 2.4 Condiciones ambientales: La humedad relativa no debe exceder el 95% a una temperatura máxima de +40°C.
- 2.5 La temperatura ambiente mínima no debe ser inferior a -40°C.
- 2.6 La temperatura ambiente máxima no debe ser superior a +40°C.
- 2.7 El interruptor debe estar en posición vertical o horizontal.
- 2.8 La temperatura ambiente no debe ser inferior a -40°C.
- 2.9 La temperatura ambiente no debe ser superior a +40°C.
- 2.10 La temperatura ambiente no debe ser superior a +40°C.
- 2.11 La temperatura ambiente no debe ser superior a +40°C.
- 2.12 La temperatura ambiente no debe ser superior a +40°C.
- 2.13 La temperatura ambiente no debe ser superior a +40°C.
- 2.14 La temperatura ambiente no debe ser superior a +40°C.
- 2.15 La temperatura ambiente no debe ser superior a +40°C.
- 2.16 La temperatura ambiente no debe ser superior a +40°C.
- 2.17 La temperatura ambiente no debe ser superior a +40°C.
- 2.18 La temperatura ambiente no debe ser superior a +40°C.
- 2.19 La temperatura ambiente no debe ser superior a +40°C.
- 2.20 La temperatura ambiente no debe ser superior a +40°C.



NMB - Electromecánicos
NMBS - Electrónicos

3. Composición de la referencia

N M B 8 1 0 0 0 1 0 1 0

Composición del código:
M para protección de motor.
N para protección magnotérmica.
B para protección térmica.
8: 3 polos.
1: 4A, sin bloque de relés de protección.
0: 4A, sin bloque de relés de protección.
0: 4A, sin bloque de relés de protección.
0: 4A, sin bloque de relés de protección.
0: 4A, sin bloque de relés de protección.
0: 4A, sin bloque de relés de protección.
0: 4A, sin bloque de relés de protección.
0: 4A, sin bloque de relés de protección.

- 4. Display**
NMB Interruptores automáticos
1. Cuerpo
 2. Bloque relés magnotérmica
 3. Bloque relés electrónico
 4. Base enchufable
 5. Módulo protección diferencial
 6. Módulo auxiliar manual
 7. Mando motor
 8. Tablita de mínima tensión
 9. Tablita emisión de corriente
 10. Contacto de alarma
 11. Contacto auxiliar
 12. Típatas de conexión frontal
 13. Típatas de conexión posterior
 14. Bloqueo por cambio
 15. Cubillos bajo
 16. Cubillos alto
 17. Adaptador a guía Din
 18. Terminal de jaula

Identificación del poder de corte:
S: Estándar.
R: Amortiguado de corriente.
M: relés electrónico.
Comentarios base de los aparatos:
125, 250, 400, 630, 800, 1250A
Los modelos 5 y 8 utilizan tecnología de identificación del tipo de relé de protección:
S: relés electrónicos.
M: relés sólo magnético.
Número de secuencia de diseño.
Código de Chant.

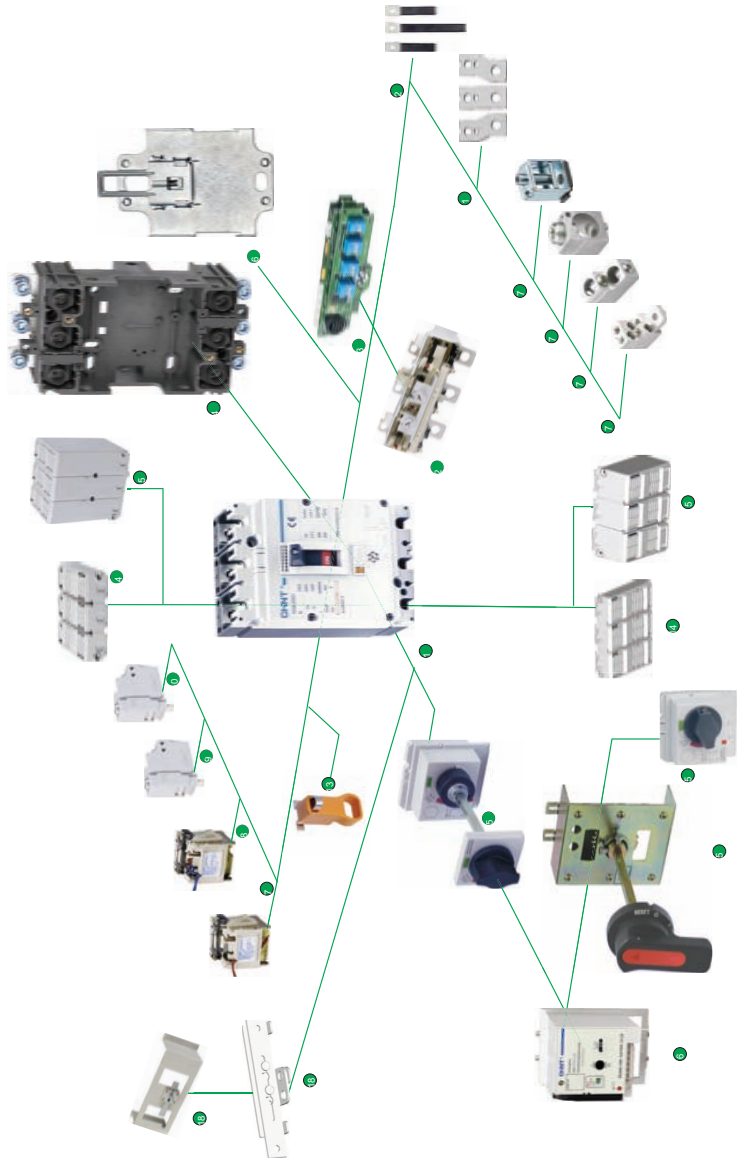



4. Partes técnicas		NM8-125		NM8-250		NM8-400		NM8-630		NM8-800		NM8-1250		NM8S-125		NM8S-250		NM8S-400		NM8S-630		NM8S-800		NM8S-1250	
3. Características		Tabla 1		Tabla 2		Tabla 3		Tabla 4		Tabla 5		Tabla 6		Tabla 7		Tabla 8		Tabla 9		Tabla 10		Tabla 11		Tabla 12	
Construcción eléctrica según IEC 60947-2		100, 125, 160, 180, 200, 225, 250		100, 125, 160, 180, 200, 225, 250		100, 125, 160, 180, 200, 225, 250		100, 125, 160, 180, 200, 225, 250		100, 125, 160, 180, 200, 225, 250		100, 125, 160, 180, 200, 225, 250		100, 125, 160, 180, 200, 225, 250		100, 125, 160, 180, 200, 225, 250		100, 125, 160, 180, 200, 225, 250		100, 125, 160, 180, 200, 225, 250		100, 125, 160, 180, 200, 225, 250		100, 125, 160, 180, 200, 225, 250	
Impulso de tensión inductiva (kV)		U _i		U _i		U _i		U _i		U _i		U _i		U _i		U _i		U _i		U _i		U _i		U _i	
Tensión de servicio (V)		U _n		U _n		U _n		U _n		U _n		U _n		U _n		U _n		U _n		U _n		U _n		U _n	
Poles		3		4		3		4		3		4		3		4		3		4		3		4	
Código según el poder de corte		1250/125/200/250		250/250/125/250		400/400/125/400		630/630/125/630		800/800/125/800		1250/1250/125/1250		1250/1250/125/1250		1250/1250/125/1250		1250/1250/125/1250		1250/1250/125/1250		1250/1250/125/1250		1250/1250/125/1250	
Poder de corte último (kA RMS) para		3000/2000/1500		3000/2000/1500		3000/2000/1500		3000/2000/1500		3000/2000/1500		3000/2000/1500		3000/2000/1500		3000/2000/1500		3000/2000/1500		3000/2000/1500		3000/2000/1500		3000/2000/1500	
Poder de corte en servicio (kA RMS) (Ics)		3000/2000/1500		3000/2000/1500		3000/2000/1500		3000/2000/1500		3000/2000/1500		3000/2000/1500		3000/2000/1500		3000/2000/1500		3000/2000/1500		3000/2000/1500		3000/2000/1500		3000/2000/1500	
Adecuado para aislamiento		No		No		No		No		No		No		No		No		No		No		No		No	
Seguridad de aislamiento		No		No		No		No		No		No		No		No		No		No		No		No	
Vida (ciclo CD)		20.000		20.000		20.000		20.000		20.000		20.000		20.000		20.000		20.000		20.000		20.000		20.000	
Acciones eléctricas		Electrónica		Electrónica		Electrónica		Electrónica		Electrónica		Electrónica		Electrónica		Electrónica		Electrónica		Electrónica		Electrónica		Electrónica	
Protección contra sobrecargas		No		No		No		No		No		No		No		No		No		No		No		No	
Protección diferencial		No		No		No		No		No		No		No		No		No		No		No		No	
Módulos y conexiones		No		No		No		No		No		No		No		No		No		No		No		No	
FIP		No		No		No		No		No		No		No		No		No		No		No		No	
CEM		No		No		No		No		No		No		No		No		No		No		No		No	
Estratificación		No		No		No		No		No		No		No		No		No		No		No		No	
Manual		No		No		No		No		No		No		No		No		No		No		No		No	
Mando motor		No		No		No		No		No		No		No		No		No		No		No		No	
Botón de emergencia de mínima tensión		No		No		No		No		No		No		No		No		No		No		No		No	
Conexión auxiliar y de alarma		No		No		No		No		No		No		No		No		No		No		No		No	
Acciones de protección diferencial		No		No		No		No		No		No		No		No		No		No		No		No	
Acciones de protección contra sobrecargas		No		No		No		No		No		No		No		No		No		No		No		No	
Terminales para cable		No		No		No		No		No		No		No		No		No		No		No		No	
Relés para conexión frontal		No		No		No		No		No		No		No		No		No		No		No		No	
Acciones para conexión frontal		No		No		No		No		No		No		No		No		No		No		No		No	
Acciones para conexión extraíble		No		No		No		No		No		No		No		No		No		No		No		No	
Acciones para conexión entre buses		No		No		No		No		No		No		No		No		No		No		No		No	
Medidas y peso		No		No		No		No		No		No		No		No		No		No		No		No	
Dimensiones (mm) (WxAlxP)		200x100x70		200x100x70		200x100x70		200x100x70		200x100x70		200x100x70		200x100x70		200x100x70		200x100x70		200x100x70		200x100x70		200x100x70	
Peso (kg)		0,45		0,45		0,45		0,45		0,45		0,45		0,45		0,45		0,45		0,45		0,45		0,45	

Nota(1): La corriente nominal del aparato NM8S-630 eschulada es, máximo, 510A.

NM8M Interruptores automáticos (Sólo Magnéticos)		NM8M-125			NM8M-250		
4 Tamaños		Tamaño 1			Tamaño 2		
Características eléctricas según UNE-EN60947-2 y UNE-EN60947-4		6,20,25,32,40,50,63,80,100,125			16,20,25,32,40,50,63,80,100,125		
Corriente nominal (A) I_n		750			750		
Tensión de aislamiento (V) U_i		8			8		
Impulso de tensión instantáneo (kV) U_{imp}		690			690		
Tensión de servicio (V) U_e	Corriente alterna 50/60Hz	500			500		
	Corriente continua	3			4		
Polos		3			3		









Código de poder de corte		S	H	R	S	H	S	H	R	
Poder de corte último (kA RMS) I_{cu}	220V/230V/240Vca	85	100	125	85	100	85	100	125	
	380V/415Vca	50	100	125	50	100	50	100	125	
	440Vca	50	100	125	50	100	50	100	125	
	500Vca	35	50	70	35	50	35	50	70	
	660V/690Vca	8	10	20	8	10	8	10	20	
	250Vcc (1P)	-	50	-	-	-	-	50	-	
500Vcc (2P)	-	50	-	-	-	-	50	-		
750Vcc (3P)	-	50	-	-	-	-	50	-		
Poder de corte en servicio $I_{cs} = (\%I_{cu})$		100			100			100		
Adecuado para aislamiento		■			■			■		
Categoría de utilización		A			A			A		
Seguridad de aislamiento		■			■			■		
Vidas (ciclos CO)	Mecánica	20.000			20.000			20.000		
	Eléctrica	20.000			20.000			20.000		
Protección		Magnética			Magnética			Magnética		
Accesorios eléctricos		■			■			■		
Protección contra cortocircuitos		■			■			■		
Protección diferencial	Con adición del módulo de protección diferencial	-			-			-		
Monaje y conexiones		■			■			■		
Fijo	Conexión frontal	■			■			■		
	Conexión posterior	■			■			■		
Guía DIN	Conexión frontal	■			■			■		
Enchufable	Conexión frontal	■			■			■		
	Conexión posterior	■			■			■		
Auxiliares para control y señalización		■			■			■		
Accionamiento manual	Mando maneta (tumbler)	■			■			■		
	Directo o con eje prolongado	■			■			■		
Mando motor		■			■			■		
Sistema de conmutación automática manual o remoto		■			■			■		
Bobinas de emisión y de mínima tensión		■			■			■		
Contactos auxiliar y de alarma		■			■			■		
Bloqueo por candado		■			■			■		
Accesorios de montaje y conexión:		■			■			■		
Terminales para cable		■			■			■		
Pletinas para conexión frontal		■			■			■		
Pletinas para conexión posterior		■			■			■		
Adaptador a guía Din		■			■			■		
Accesorios para conexión enchufable		■			■			■		
Cubrebornes		■			■			■		
Barreras de protección entre fases		■			■			■		
Medidas y peso		■			■			■		
Dimensiones (mm)W×L×H		90×140×79			120×140×79			105×127×88		
Peso (kg)		1.2			1.6			2.1		

5.2 Aplicaciones en Corriente Continua

Para obtener el número de polos en serie necesarios para garantizar la capacidad de interrupción (poder de corte Icu) a las distintas tensiones nominales, pueden usarse los esquemas adjuntos.

- Esquemas de protección y seccionamiento del circuito usando interruptores tripolares y tetrapolares
- $I_{cu} = I_{cs} = 10kA$ para cualquier otra conexión no incluida en las siguientes.

Esquema A: Interrupción con un polo por polaridad

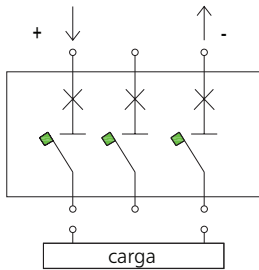

Nota: Sin el polo negativo conectado a tierra, el método de instalación debe preverse para el caso de que se produjera un segundo defecto a tierra.

Esquema B: Interrupción con dos polos en serie para una polaridad y un polo para la otra polaridad.

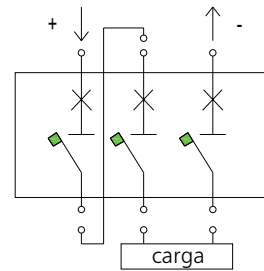

Nota: Sin el polo negativo conectado a tierra, el método de instalación debe preverse para el caso de que se produjera un segundo defecto a tierra.

Esquemas C, C1: Interrupción con tres y cuatro polos en serie por polaridad.

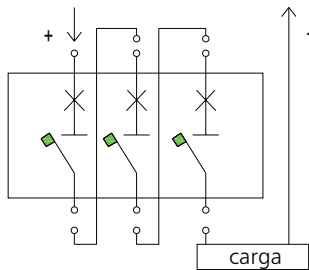

Esquema D: Interrupción con tres polos en serie para una polaridad y un polo para la otra polaridad (4C, 4D)

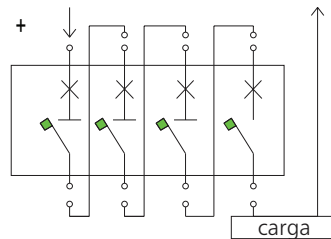

Nota: Sin el polo negativo conectado a tierra, el método de instalación debe preverse para el caso de que se produjera un segundo defecto a tierra.

Esquema E: Interrupción con dos polos en serie por polaridad (4C, 4D)

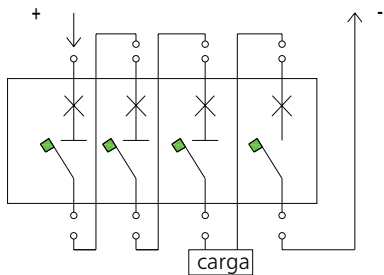

Nota: Sin el polo negativo conectado a tierra, el método de instalación debe preverse para el caso de que se produjera un segundo defecto a tierra.

Esquema F: Interrupción con dos polos en serie por polaridad (4C, 4D)

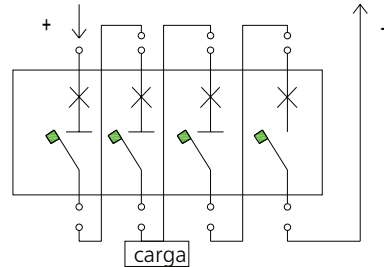

Nota: Sin el polo negativo conectado a tierra, el método de instalación debe preverse para el caso de que se produjera un segundo defecto a tierra.

La siguiente tabla muestra que esquema de conexión debe usarse, de acuerdo con el número de polos a ser conectado en serie, para obtener la capacidad de interrupción requerida, en relación con el tipo de red de distribución.

Tensión nominal	Función de protección	Aislamiento	Red aislada de tierra	Red con una polaridad a tierra(1)	Red con el punto medio a tierra
≤250	■	■	A	A	A
	■	-	-	-	-
≤500	■	■	A	B	A
	■	-	-	C	-

Notas:

- a. El riesgo de doble defecto a tierra es nulo, por ello la corriente de defecto sólo afecta a una parte de los polos de interrupción.
- b. Para conexiones con cuatro polos en serie deben usarse interruptores con el neutro calibrado al 100% de la corriente de fase.

6. Relés

6.1 Relés magnetotérmicos electromecánicos

6.1.1 Los relés de los interruptores NM8-125, 250, 400, 630, 800 and 1250 pueden ser ajustados a cualquier requerimiento de protección

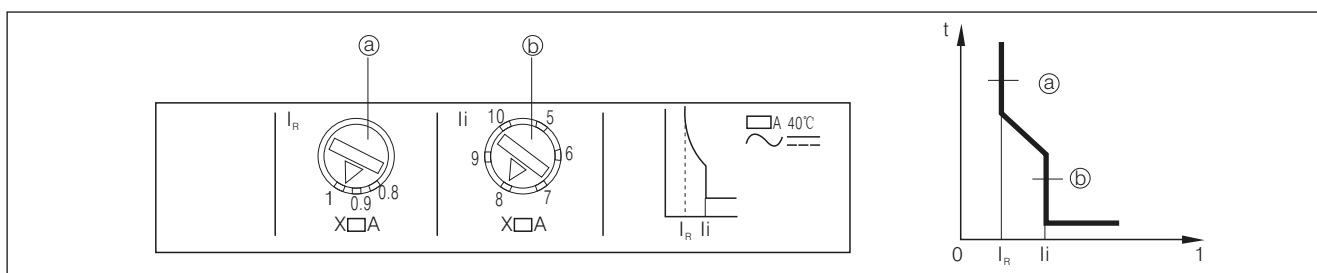

Parámetros de ajuste para protección contra sobrecargas (a)
 Parámetros de ajuste para protección contra cortocircuitos (b)

Relés electromecánicos	NM8-125	NM8-250	NM8-400	NM8-630	NM8-800	NM8-1250
Corriente nominal (I _n) Amp. a 40°C	16, 20, 25, 32, 40, 50, 63, 80, 100, 125	100, 125, 160, 180, 200, 225, 250	250, 315, 350, 400	250, 315, 350, 400, 500	630, 700, 800	630, 700, 800, 1000, 1250
Protección contra sobrecargas	Protección térmica					
Corriente disparo I _R (A)	Ajustable 0.8~1xI _n	Ajustable 0.8~1xI _n	Ajustable 0.8~1xI _n	Ajustable 0.8~1xI _n	Ajustable 0.8~1xI _n	Ajustable 0.8~1xI _n
Protección del neutro (A) 4A, 4B 4C, 4D 4E, 4F	Sin protección 1.0xI _n 0.5xI _n	Sin protección 1.0xI _n 0.5xI _n	Sin protección 1.0xI _n 0.5xI _n	Sin protección 1.0xI _n 0.5xI _n	Sin protección 1.0xI _n 0.5xI _n	Sin protección 1.0xI _n 0.5xI _n
Protección contra cortocircuitos	Protección magnética					
Corriente disparo I _i (A)	10I _n (Protección distribución) 12I _n (Protección motores)	Ajustable 5~10 XI _n 8~12I _n (Protección motores)	Ajustable 5~10 XI _n 8~12I _n (Protección motores)	Ajustable 5~10 XI _n 8~12I _n (Protección motores)	Ajustable 5~10 XI _n 8~12I _n (Protección motores)	Ajustable 5~10 XI _n 8~12I _n (Protección motores)

6.1.2 Características de la protección térmica del los relés electromecánicos, para distribución de potencia

Serie	Corriente de prueba	I/I _n	Tiempo	Estado inicial
1	Corriente de no desconexión	1.05	> 1h (I _n ≤ 63A) > 2h (I _n > 63A)	Frio
2	Corriente de desconexión	1.3	≤ 1h (I _n ≤ 63A) ≤ 2h (I _n > 63A)	Después de la serie 1

6.1.3 Características de la protección térmica de los relés electromecánicos, para protección de motores

Serie	Corriente de prueba	I/In	Tiempo	Estado inicial
1	Corriente de no desconexión	1.0	>2h	Frio
2	Corriente de desconexión	1.2	≤2h	Después de la serie 1
		1.5	≤4min	
		7.2	4s ≤ T ≤ 10s	

6.2 Relés electrónicos

6.2.1 El relé electrónico de los interruptores NM8S-125 y NM8S-250 es un módulo universal el cual posee seis ajustes de corriente: 40A, 50A, 63A, 80A, 100A, 125A, 160A, 180A, 200A, 225A y 250A con el fin de potenciar todas las prestaciones de selectividad y protección que los relés electrónicos pueden ofrecer.

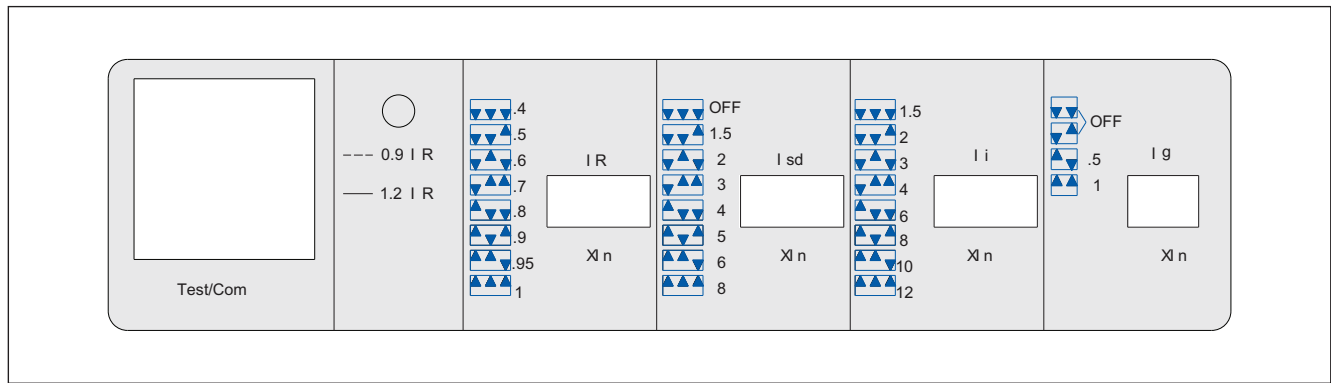

El piloto indicador parpadeará, cuando la corriente de una de las fases sea ≤ 90% I_R
El piloto indicador quedará encendido fijo, cuando la corriente de una de las fases sea ≥ 115% I_R

Relé electrónico	NM8S-125	NM8S-250
Corriente nominal I _n (20~70°C)	40, 50, 63, 80, 100, 125	100, 125, 160, 180, 200, 225, 250
Protección contra sobrecargas	Protección térmica	
Corriente de desconexión I _R	0.4, 0.5, 0.6, 0.7, 0.8, 0.9, 0.95, 1XIn	0.4, 0.5, 0.6, 0.7, 0.8, 0.9, 0.95, 1XIn
Tiempo de desconexión	1.05I _R >2h no desconexión 1.3 I _R ≤1h 1.5 I _R 96s 6I _R 6s	>2h no desconexión ≤1h 96s 6s
Protección del neutro Corriente de desconexión I _g	OFF, 0.5, 1XIn	OFF, 0.5, 1XIn
Corriente de desconexión instantánea I _i	1.5, 2, 3, 4, 6, 8, 10, 12XIn	1.5, 2, 3, 4, 6, 8, 10, 12XIn
Retardo corto de la corriente de desconexión instantánea I _{sd}	OFF, 1.5, 2, 3, 4, 6, 8XIn	OFF, 1.5, 2, 3, 4, 6, 8XIn

6.2.2 El relé electrónico de los interruptores NM8S-400 y NM8S-630 es un módulo universal el cual posee seis ajustes de corriente: 250A, 315A, 350A, 400A, 500A y 630A con el fin de potenciar todas las prestaciones de selectividad y protección que los relés electrónicos pueden ofrecer.

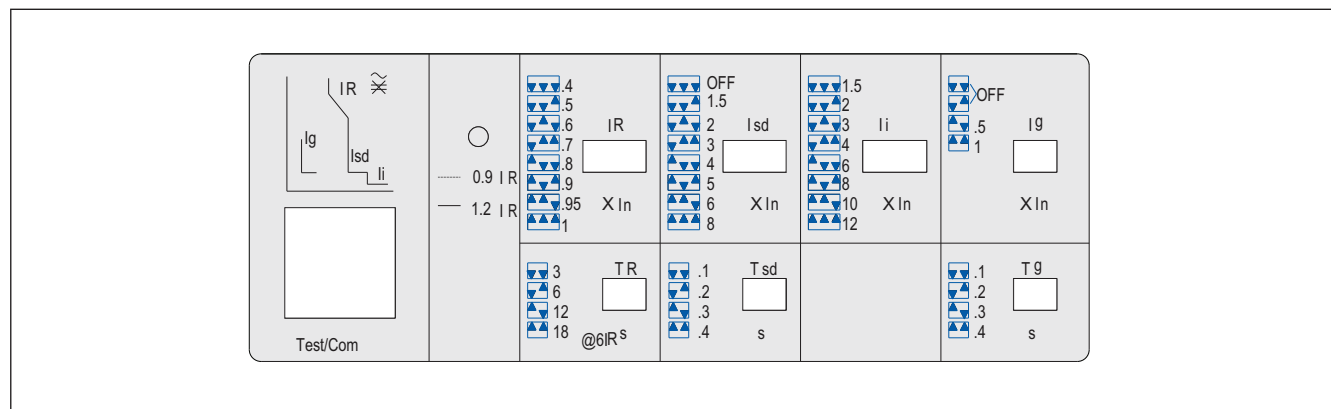

5.2.2 El relé electrónico de los interruptores NM8S-800 y NM8S-1250 es un módulo universal el cual posee cinco ajustes de corriente: 630A, 700A, 800A, 1000A y 1250A con el fin de potenciar todas las prestaciones de selectividad y protección que los relés electrónicos pueden ofrecer.

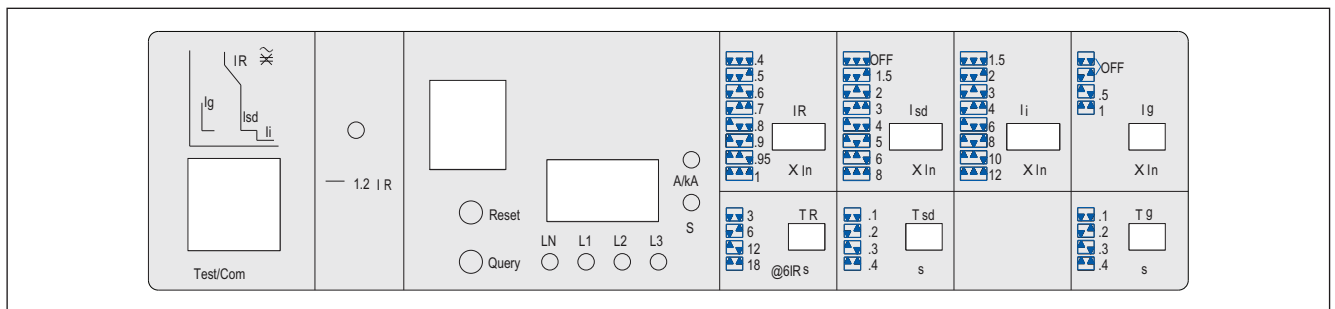

Las corrientes de desconexión I_{Rr} , I_{sd} , I_i deben ajustarse mediante el switch de tres dígitos o mediante el botón giratorio.

- (LT) Retardo largo - Ajustes para protección contra sobrecargas
 Las intensidades I_{Rr} , TR y 6IR puede ajustarse según las necesidades de protección de cada instalación

Modelo	1.05 I_R	1.3 I_R	1.5 I_R (s)	2.0 I_R (s)	6 I_R (s)
NM8S-400, 630	>2h no desconexión	<1h desconexión	48,96, 192, 288	27, 54, 108, 162	3, 6, 12, 18
NM8S-800, 1250	>2h no desconexión	<1h desconexión	48, 96, 192, 288	27, 54, 108, 162	3, 6, 12, 18

Indicación de estado del retardo largo (LT)

- El piloto parpadeará cuando la corriente de una de las fases sea $<90\%I_R$
- El piloto lucirá fijo cuando la corriente de una de las fases sea $\geq 115\%I_R$

- (ST) Retardo corto - Ajustes para la protección contra cortocircuitos, y tiempos de desconexión.
 El valor de la corriente I_{sd} y el tiempo de desconexión T_{sd} pueden ajustarse según las necesidades de protección de cada instalación.
 El parámetro I_{sd} , si se desea, puede anularse mediante la configuración OFF de los interruptores de posición.

- (I) Instantáneo - Protección contra cortocircuitos
 El valor de la corriente I_i puede ajustarse según las necesidades de protección de cada instalación.

- (Neutro) - Ajustes de protección
 Para interruptores de 4P con el polo neutro protegido, el valor de la corriente I_g puede ajustarse según las necesidades de protección de cada instalación. Si el polo neutro del aparato no estuviera protegido el estado de I_g puede anularse mediante la configuración OFF de los interruptores de posición.
 El tiempo de desconexión T_g puede ajustarse según las necesidades de protección de cada instalación.

Relé electrónico	NM8S-400	NM8S-630	NM8S-800	NM8S-1250
Corriente nominal I_n (20~70°C)	250, 315, 350, 400	250, 315, 350, 400, 500, 630	630, 700, 800	630, 700, 800, 1000, 1250
Retardo Largo Protección contra sobrecargas				
Corriente desconexión I_R (A)	0.4, 0.5, 0.6, 0.7, 0.8, 0.9, 0.95, 1XIn	0.4, 0.5, 0.6, 0.7, 0.8, 0.9, 0.95, 1XIn	0.4, 0.5, 0.6, 0.7, 0.8, 0.9, 0.95, 1XIn	0.4, 0.5, 0.6, 0.7, 0.8, 0.9, 0.95, 1XIn
Tiempo de desconexión $6I_R$ (s)	3, 6, 12, 18	3, 6, 12, 18	3, 6, 12, 18	3, 6, 12, 18
Retardo Corto Protección contra cortocircuitos				
Corriente desconexión I_{sd} (A)	OFF, 1.5, 2, 3, 4, 5, 6, 8XIn	OFF, 1.5, 2, 3, 4, 5, 6, 8XIn	OFF, 1.5, 2, 3, 4, 5, 6, 8XIn	OFF, 1.5, 2, 3, 4, 5, 6, 8XIn
Tiempo desconexión T_{sd} (s)	0.1, 0.2, 0.3, 0.4	0.1, 0.2, 0.3, 0.4	0.1, 0.2, 0.3, 0.4	0.1, 0.2, 0.3, 0.4
Instantáneo Protección contra cortocircuitos				
Corriente desconexión I_i (A)	1.5, 2, 3, 4, 6, 8, 10, 12XIn 12In(protección motores)	1.5, 2, 3, 4, 6, 8, 10, 12XIn 12In(protección motores)	1.5, 2, 3, 4, 6, 8, 10, 12XIn 12In(protección motores)	1.5, 2, 3, 4, 6, 8, 10, 12XIn 12In(protección motores)
Neutro				
Corriente desconexión I_g (A)	OFF, 0.5, 1XIn	OFF, 0.5, 1XIn	OFF, 0.5, 1XIn	OFF, 0.5, 1XIn
Tiempo desconexión T_g (s)	0.1,0.2, 0.3, 0.4	0.1,0.2, 0.3, 0.4	0.1,0.2, 0.3, 0.4	0.1,0.2, 0.3, 0.4

7. Curvas

7.1 Curvas de disparo (temperatura ambiente +40°C)

NM8-125(16A, 20A)

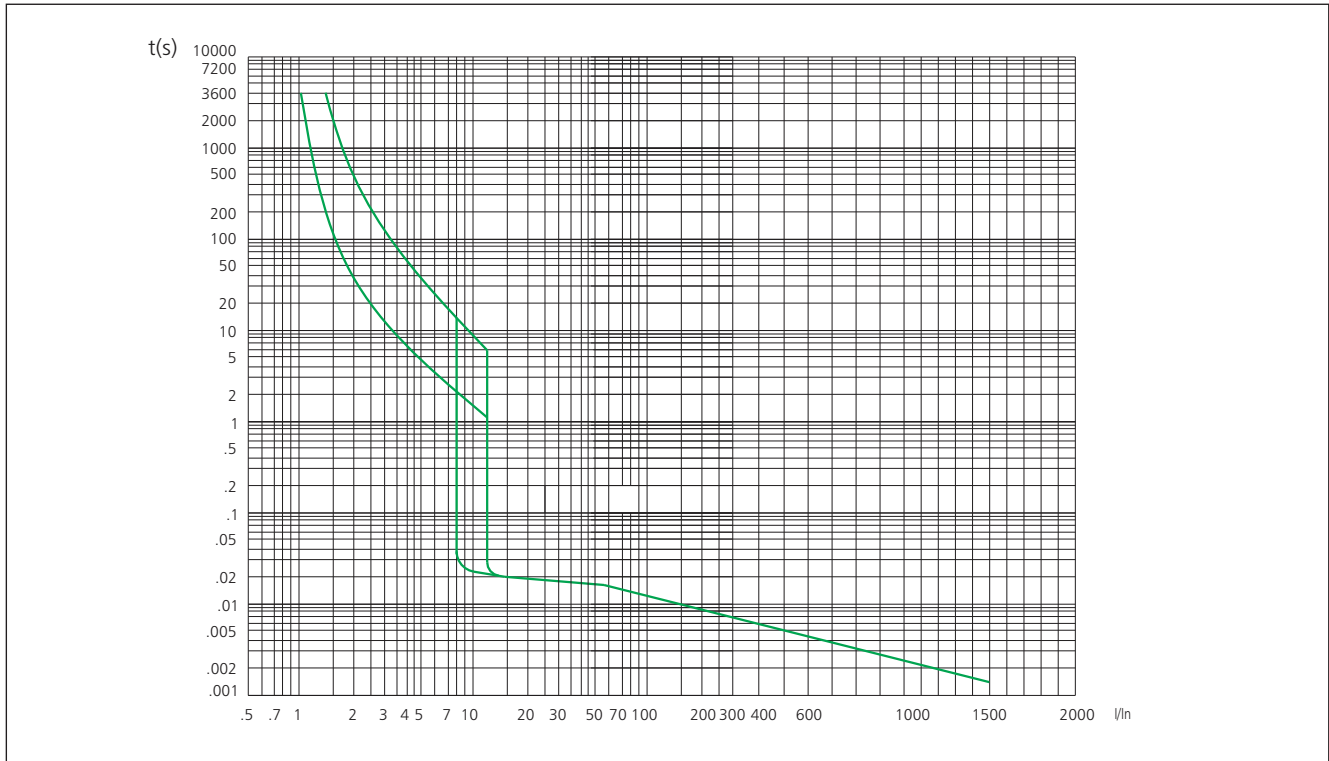

NM8-125(25A, 32A)

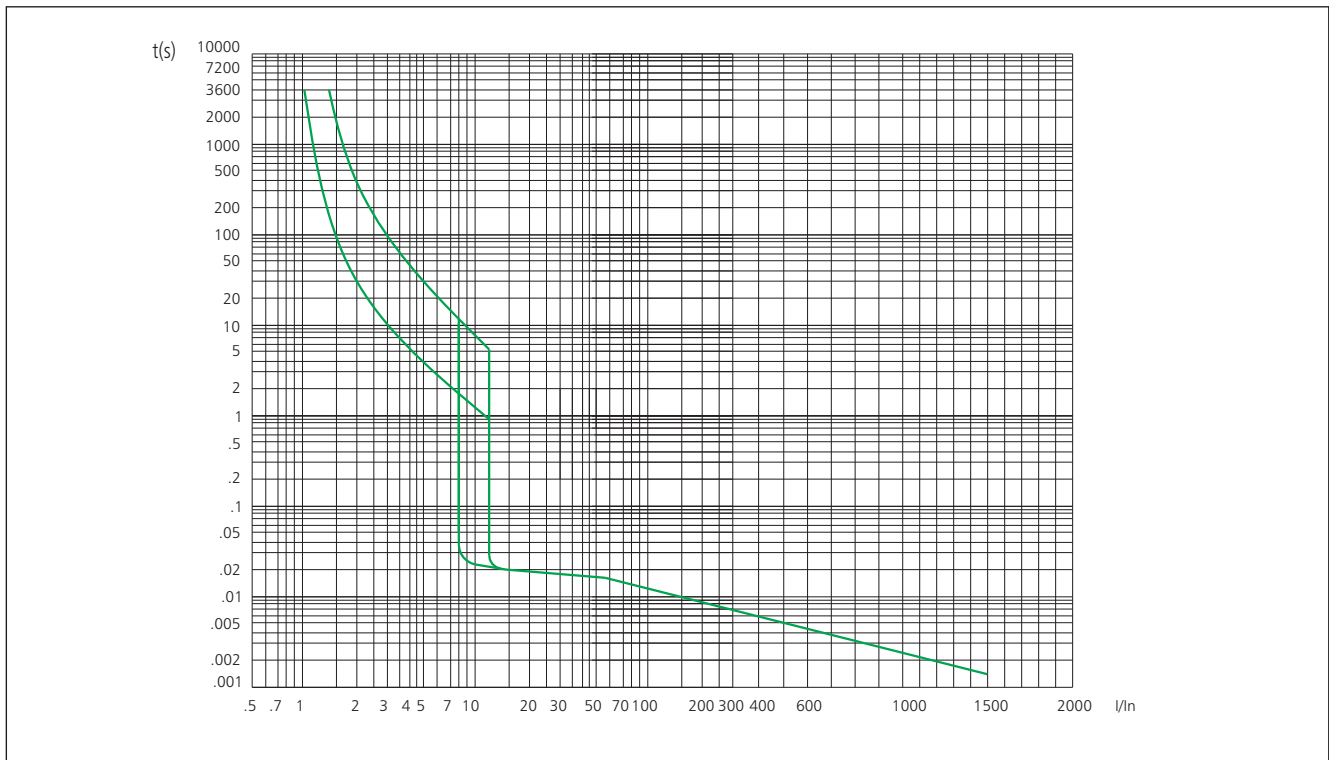

NM8-125(40A, 50A, 63A)

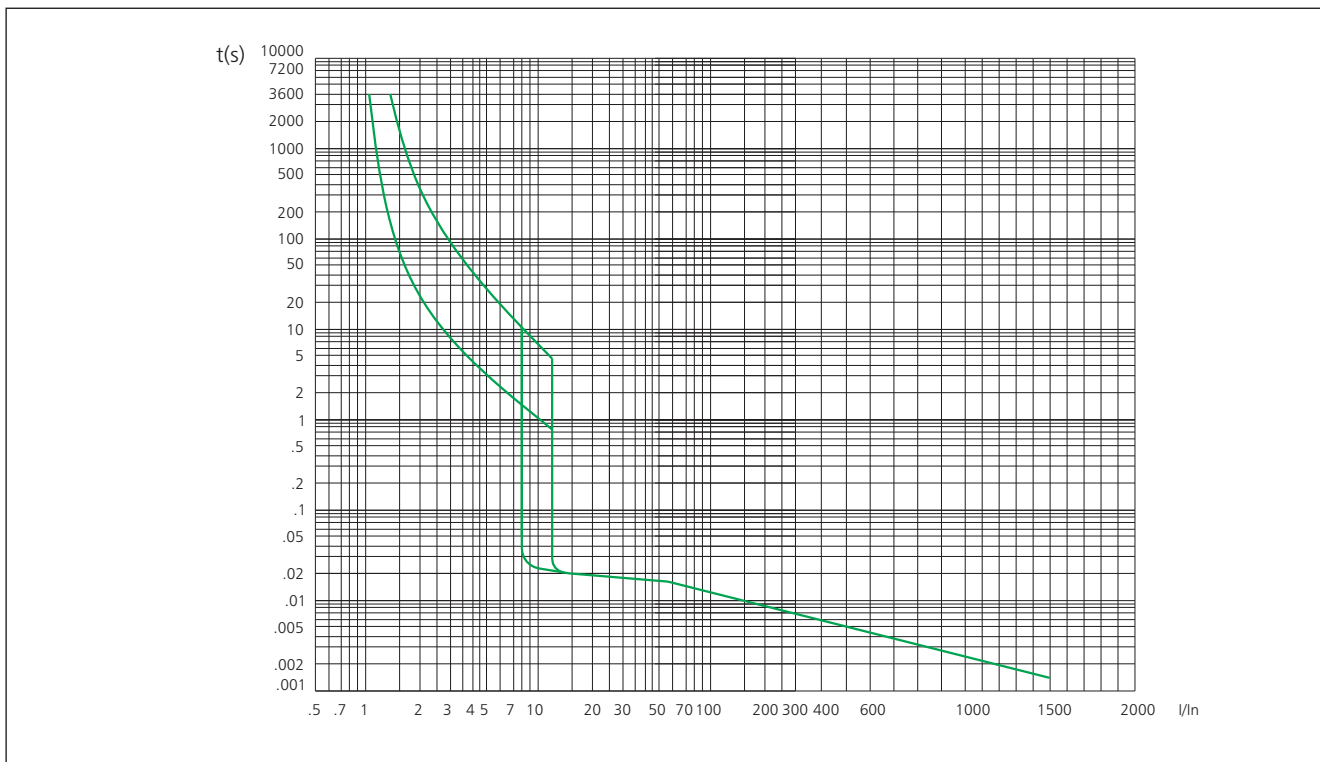

NM8-125(80A, 100A)

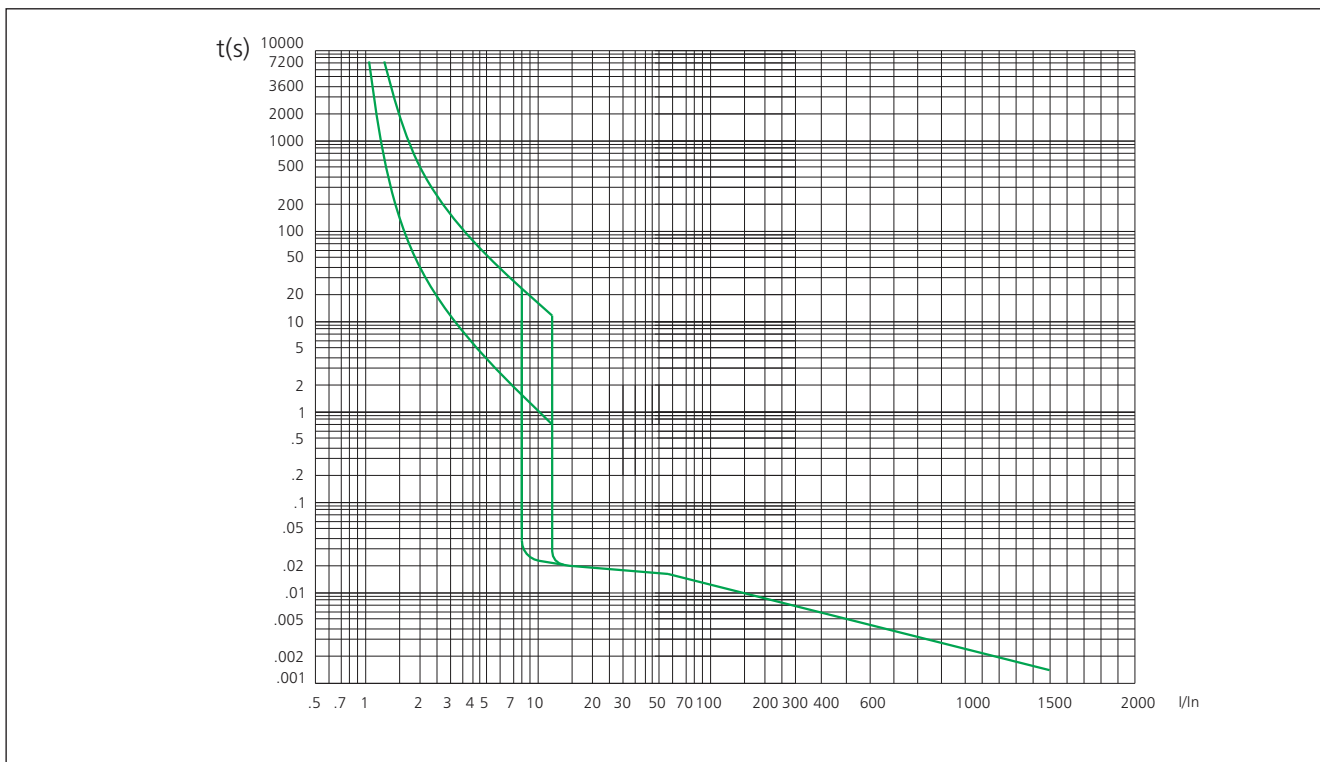

NM8-125(125A)

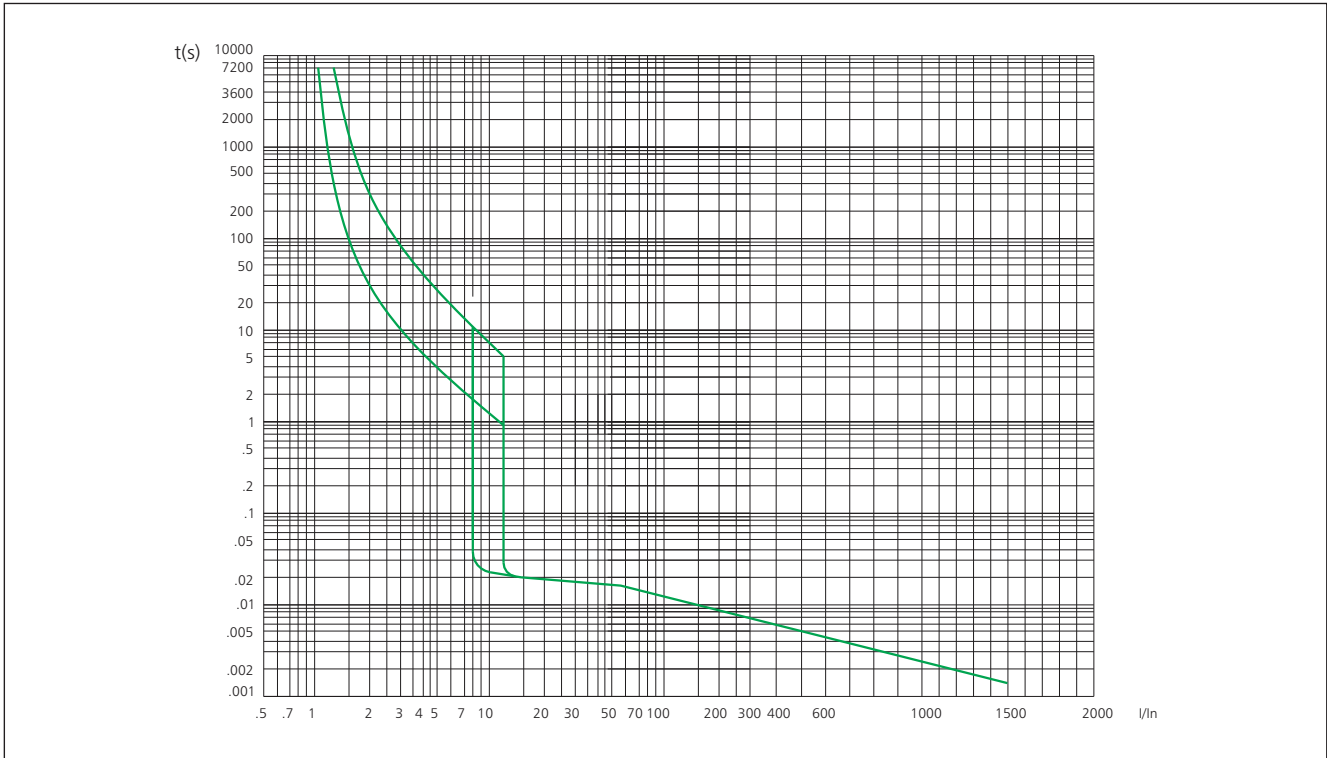

NM8-250(100A, 125A)

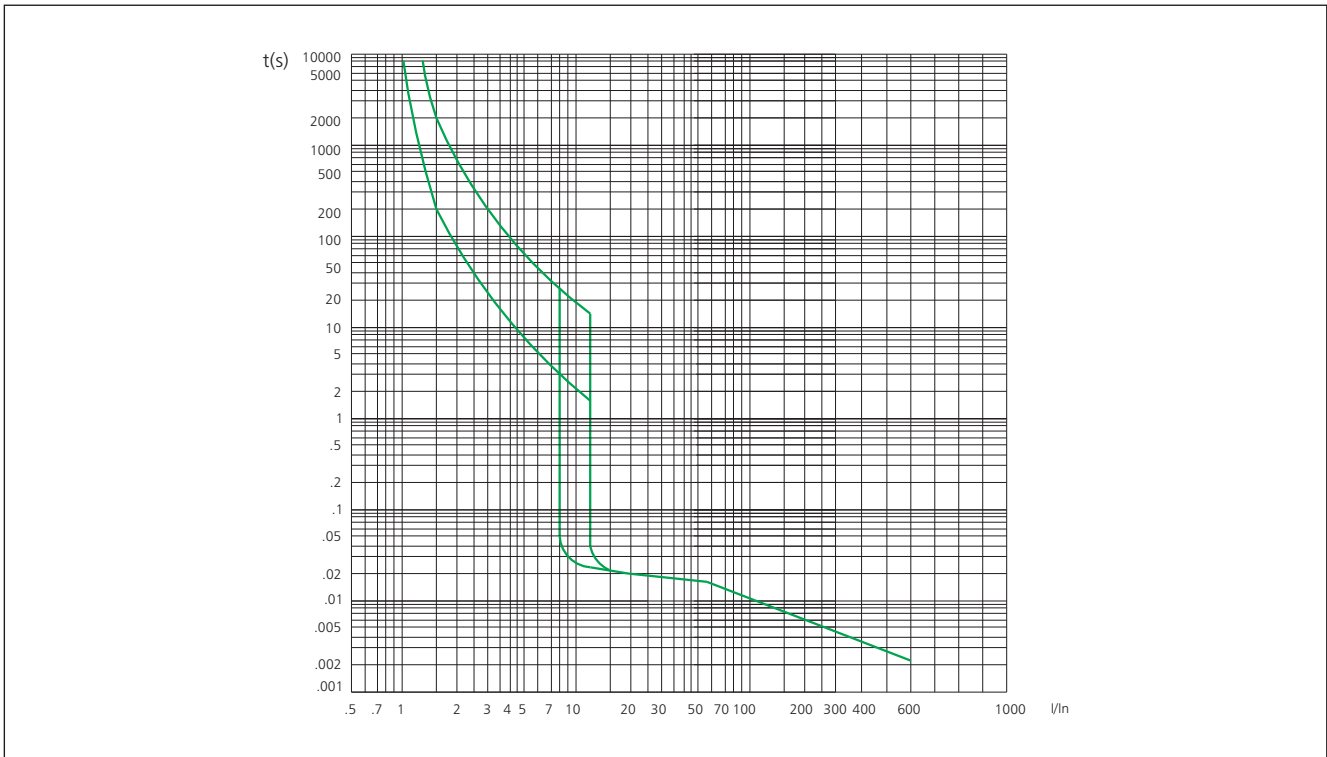

NM8-250(160A, 180A)

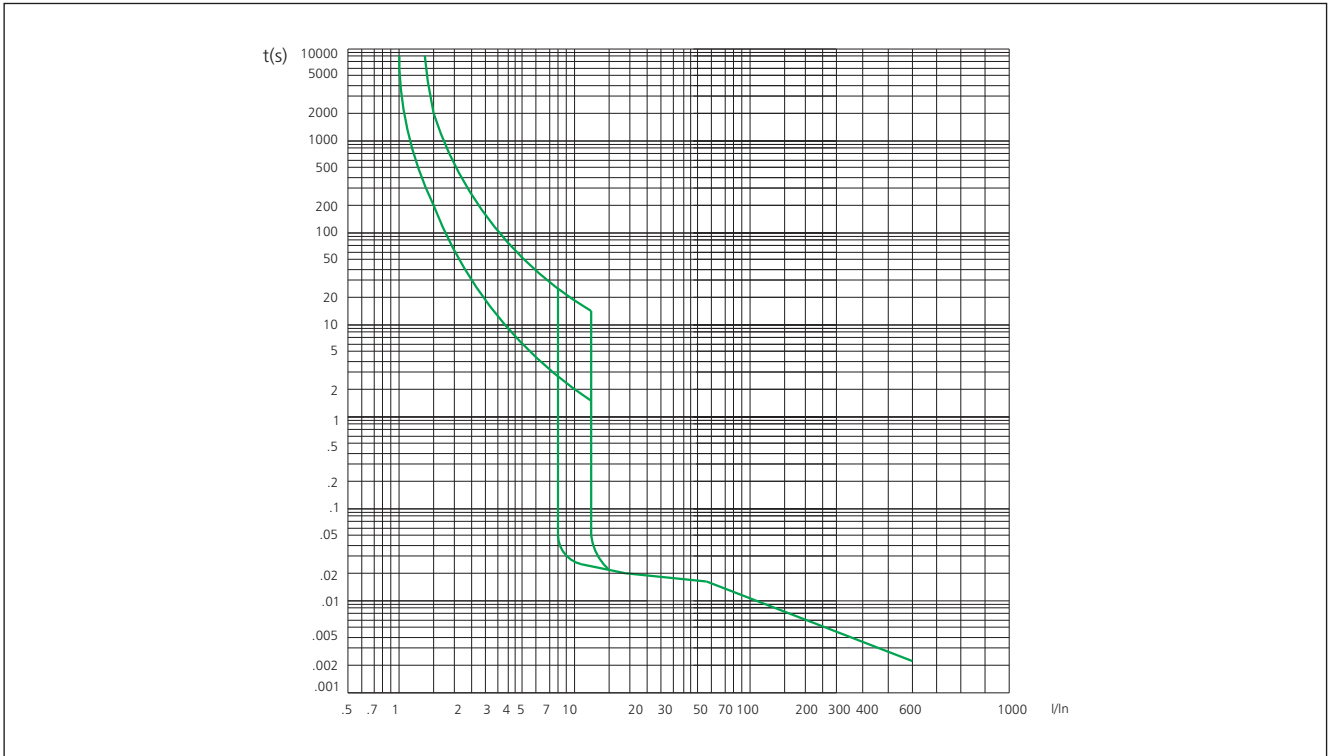

NM8-250(200A, 225A, 250A)

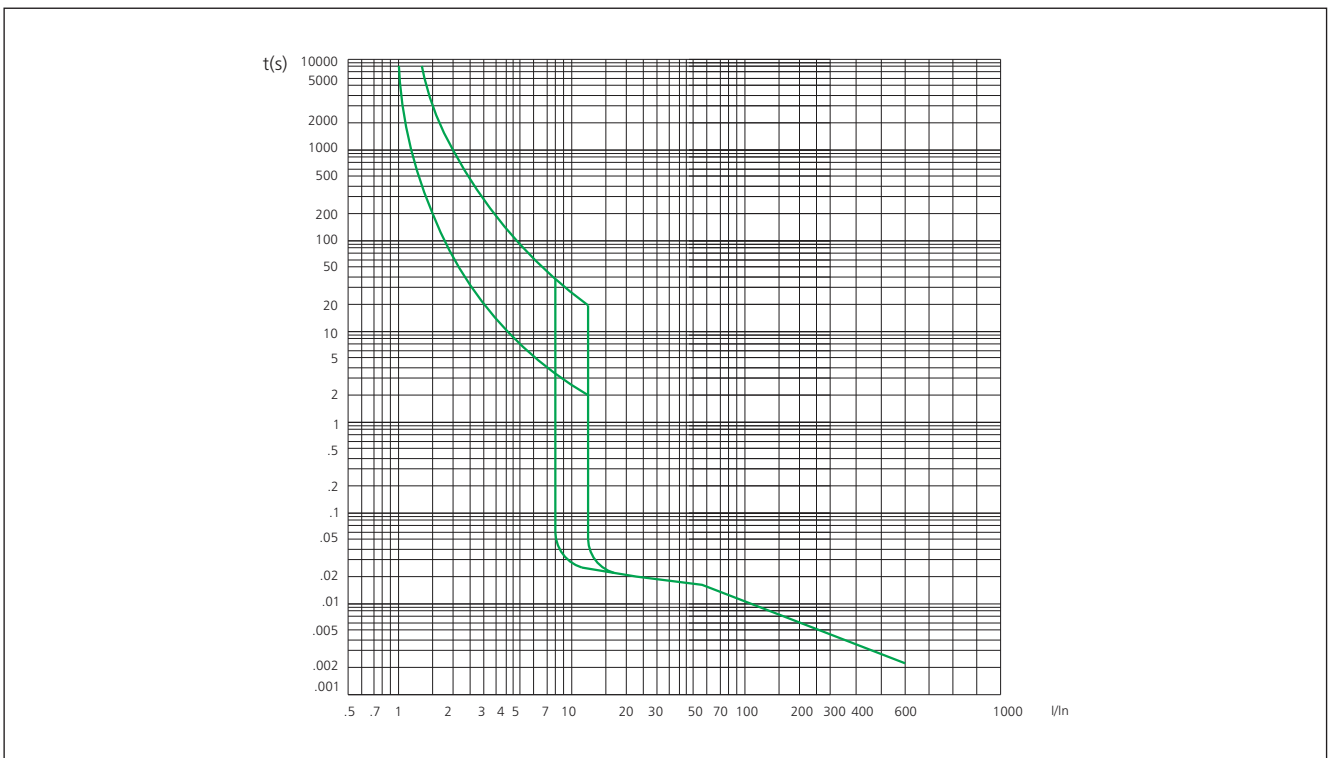

NM8-400, 630(250A~500A)

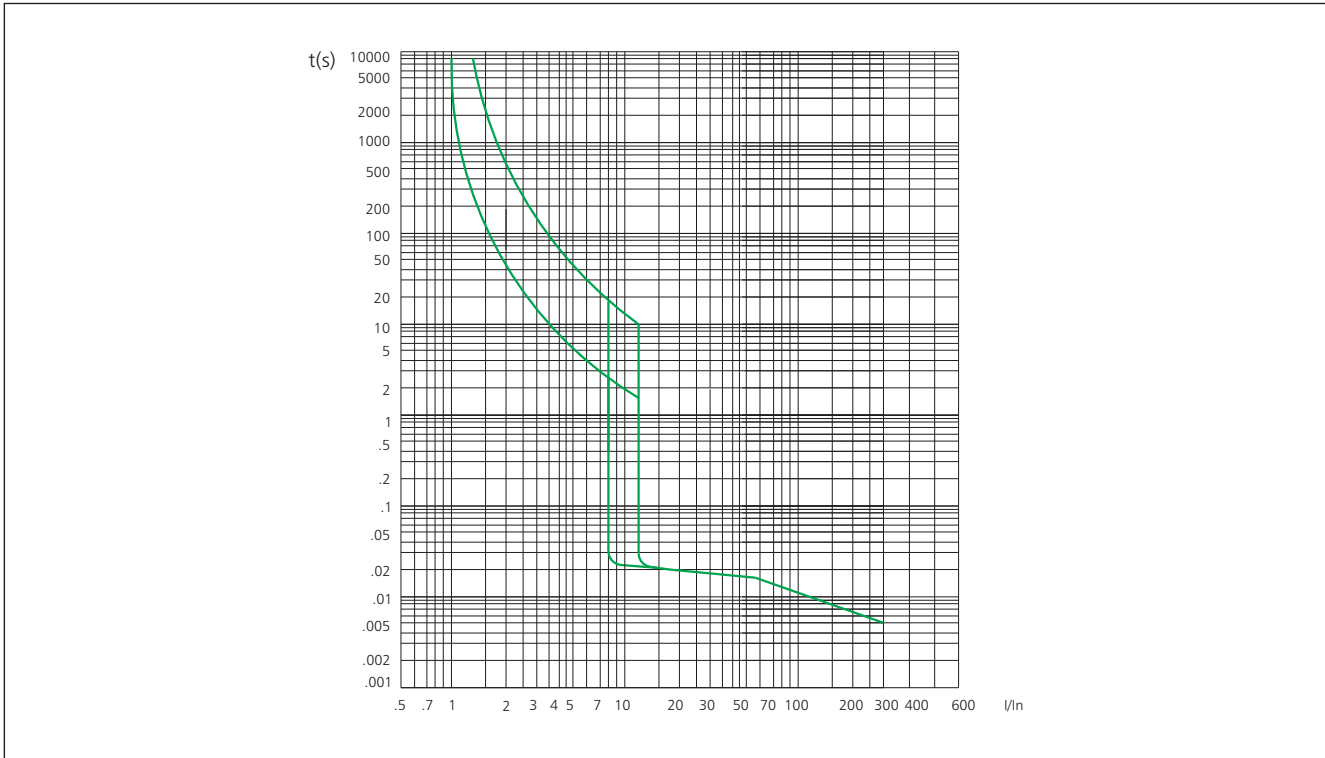

NM8-800(630A, 700A, 800A)
 NM8-1250(630A, 700A, 800A, 1000A, 1250A)

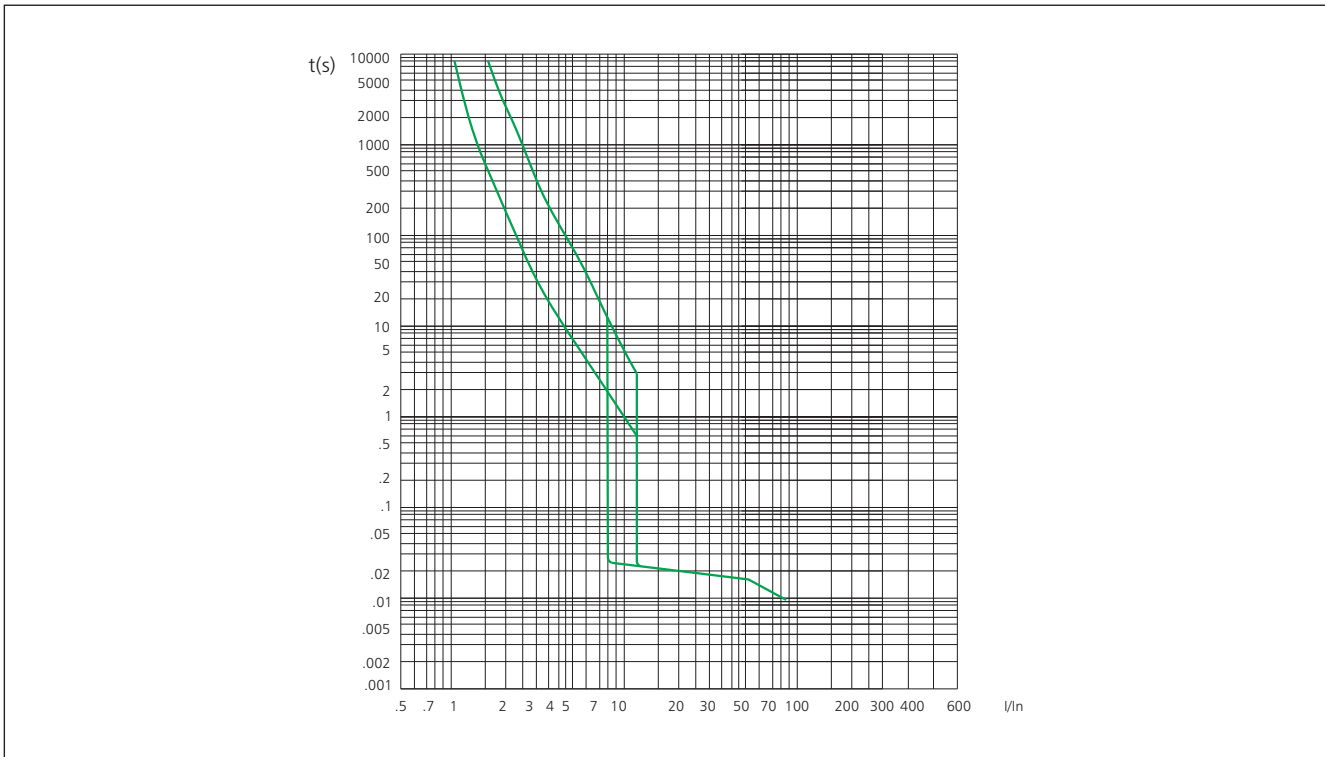

Motor protection release NM8-125, 250, 400, 630(16A~500A)

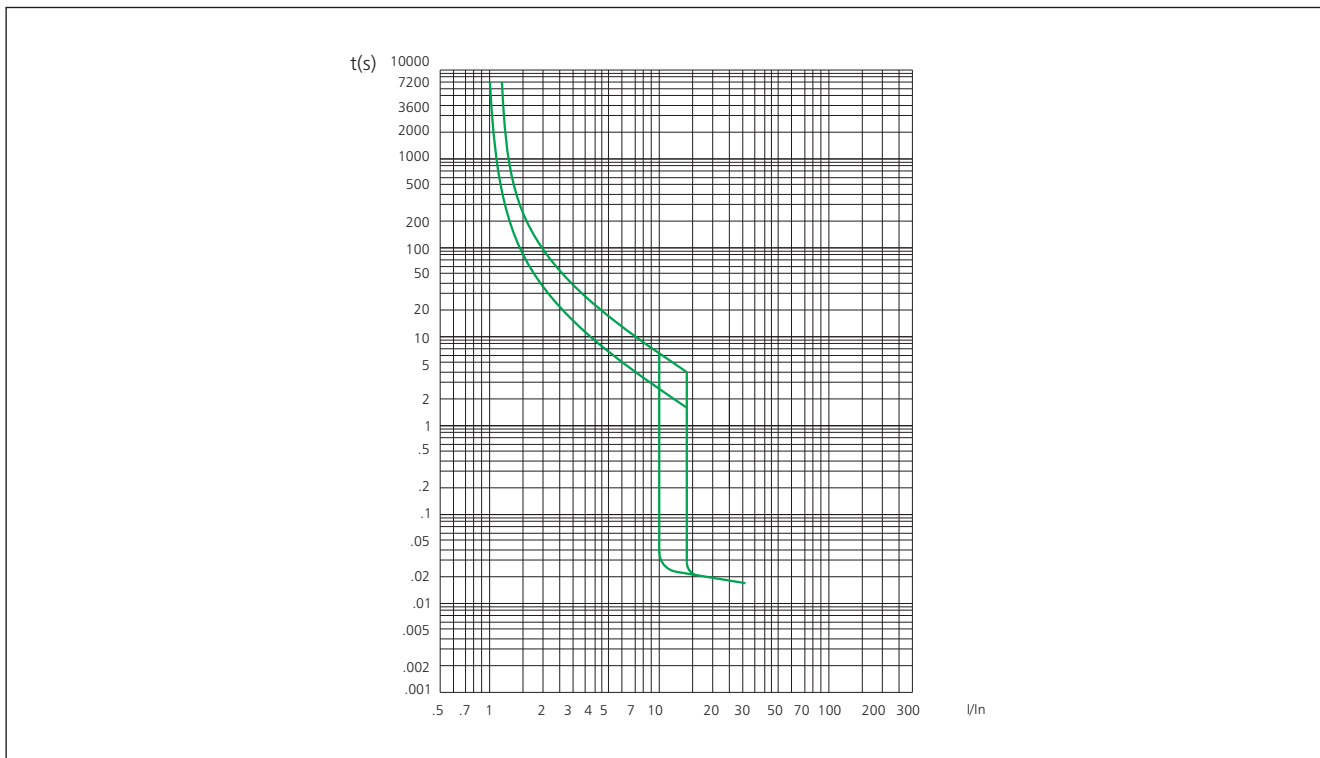

Electronic type NM8S-125, 250(40A~250A)

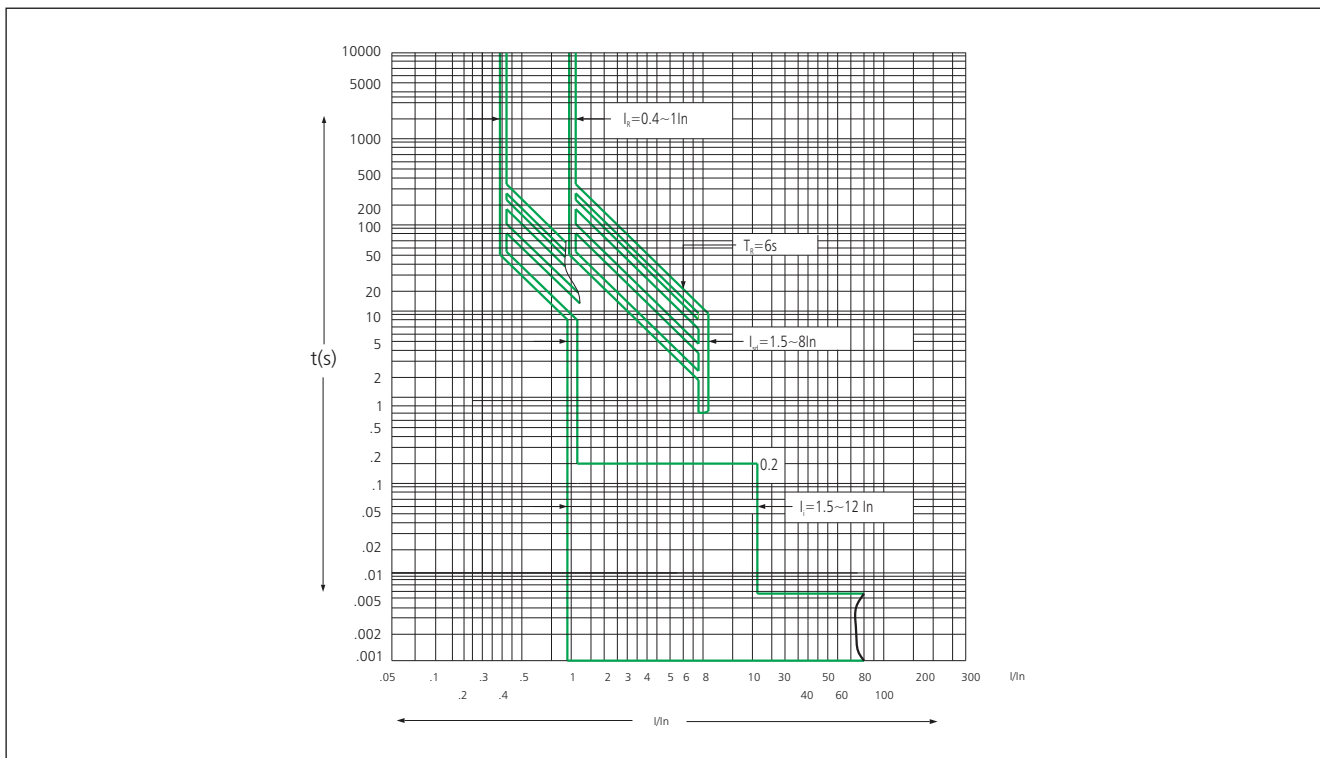

NM8S-400, 630(250A~630A)
NM8S-800, 1250(630A~1250A)

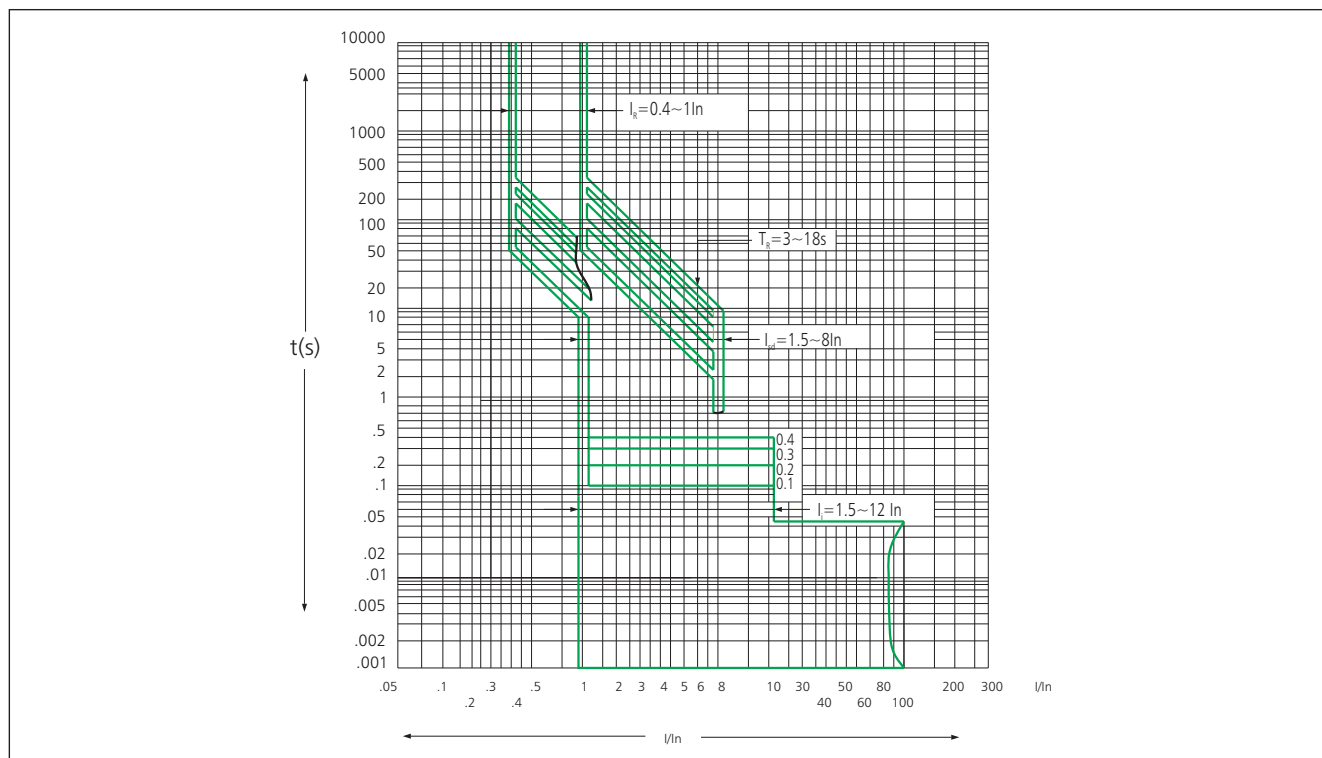

7.2 Compensación de temperatura

Cuando la temperatura ambiente en la cual está montado un interruptor automático sufre cambios cambian también las características del mismo.

7.2.1 Coeficiente de compensación de la temperatura de los interruptores con relé electromecánico

Temperatura ambiente	-40°C	-35°C	-30°C	-25°C	-20°C	-15°C	-10°C	-5°C
Coefficiente de compensación	1.4	1.375	1.35	1.325	1.3	1.275	1.25	1.225

Temperatura ambiente	0°C	5°C	10°C	15°C	20°C	25°C	30°C	35°C	40°C	45°C	50°C	55°C	60°C	65°C	70°C
Coefficiente de compensación	1.2	1.175	1.15	1.125	1.1	1.075	1.05	1.025	1.0	0.975	0.95	0.925	0.90	0.875	0.85

7.2.2 Coeficiente de compensación de la temperatura de los interruptores con relé electrónico

Corrientes de ajuste nominal	0°C	5°C	10°C	15°C	20°C	25°C	30°C	35°C	40°C	45°C	50°C	55°C	60°C	65°C	70°C
NM8S-125S/H(40~125)	1	1	1	1	1	1	1	1	1	1	1	1	1	1	1
NM8S-250S/H(125~160)	1	1	1	1	1	1	1	1	1	1	1	1	1	1	1
NM8S-250S/H(200~250)	1	1	1	1	1	1	1	1	1	1	1	0.95	0.95	0.90	0.90
NM8S-630S/H/R(250~400)	1	1	1	1	1	1	1	1	1	1	1	0.98	0.95	0.93	0.90
NM8S-630S/H/R(500~630)	1	1	1	1	1	1	1	1	1	0.98	0.95	0.93	0.90	0.88	0.85
NM8S-1250S/H/R(630~800)	1	1	1	1	1	1	1	1	1	0.975	0.975	0.95	0.95	0.925	0.925
NM8S-1250S/H/R(1000~1250)	1	1	1	1	1	1	1	1	1	0.95	0.9	0.875	0.80	0.80	0.80

8. Sistemas de montaje

8.1 Lado de la carga

Los interruptores NM8S pueden conectarse en dos modos diferentes: con los cables de entrada por la parte superior y la salida a la carga por la parte inferior o viceversa. En caso de instalarse con entrada de cables por la parte inferior y salida por la parte superior no hay que aplicar ningún tipo de depreciación del calibre del aparato.



8.2 Posiciones

8.2.1 Fijación de aparatos fijos o enchufables

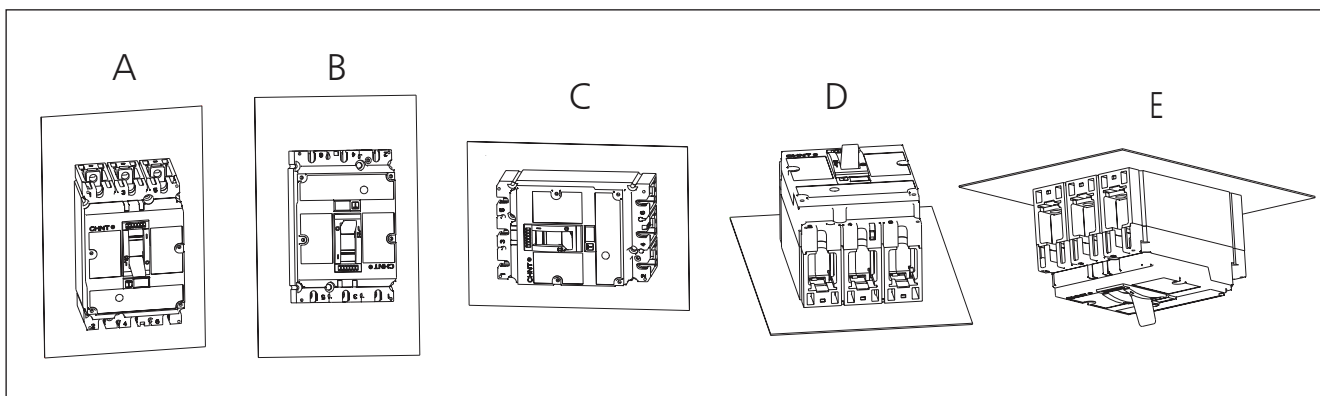

8.3 Sistemas de fijación

8.3.1 Fijación de aparatos fijos o enchufables

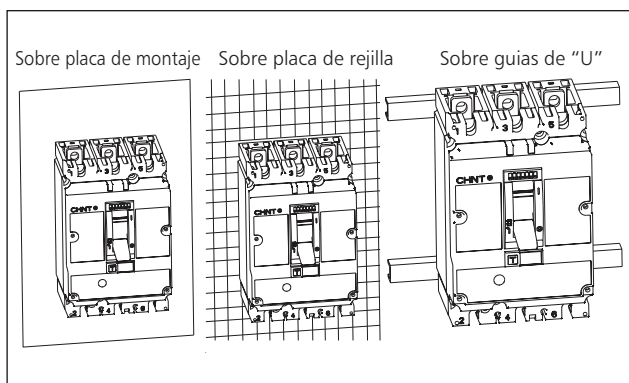

8.3.2 El adaptador a carril Din, para conexión frontal, está disponible para los interruptores NM8(S)-125 y NM8(S)-250

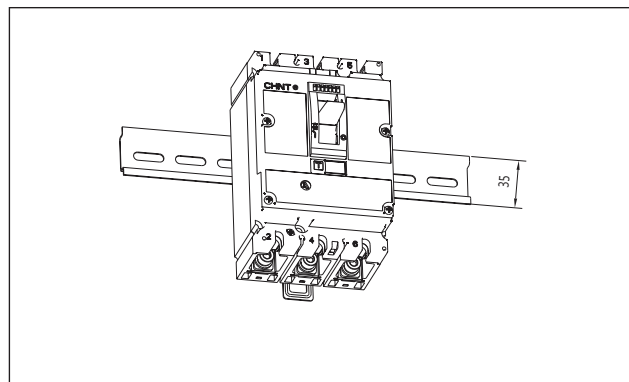

8.4 Distancias de seguridad

8.4.1 Distancia mínima entre interruptores.

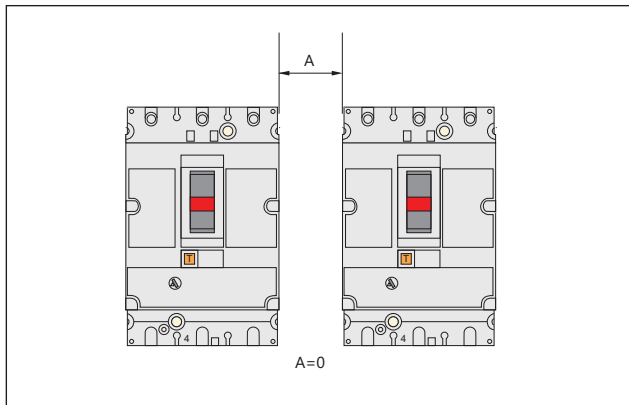

8.4.2 Distancia mínima entre el interruptor y el panel frontal del cuadro eléctrico, cuando el mando de interruptor es exterior.

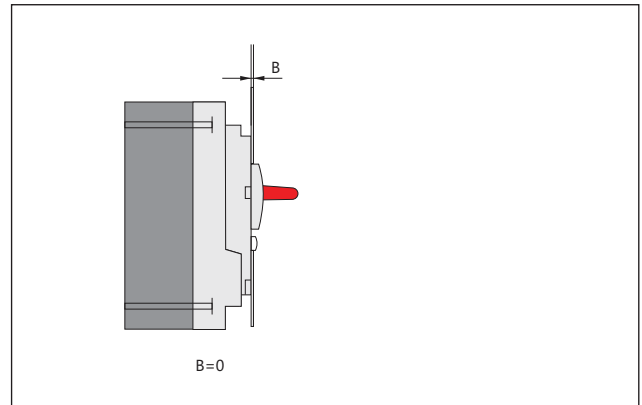

8.4.3 Distancia mínima entre el interruptor y las paredes laterales del cuadro eléctrico, cuando el mando del interruptor es exterior.

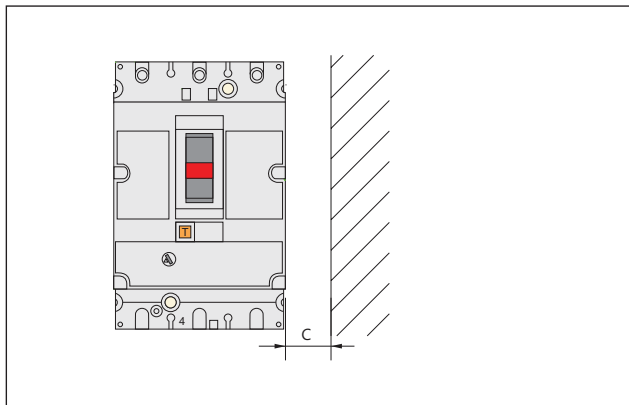

8.4.4 Distancia mínima entre el interruptor y las paredes superior e inferior del cuadro eléctrico, cuando el mando del interruptor es exterior.

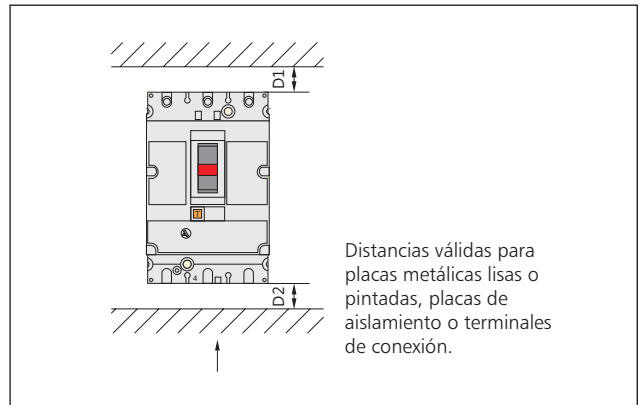

Interruptores NM8(S)	Ue	C	Placas aislantes o terminales de conexión (mm)		Placas metálicas lisas o pintadas (mm)	
			D1	D2	D1	D2
NM8-125 NM8S-125	Ue ≤ 440V	10	30	30	35	35
	Ue < 600V	20	30	30	35	35
NM8-250 NM8S-250	Ue ≥ 600V	30	30	30	35	35
	Ue ≤ 440V	10	30	30	35	35
	Ue < 600V	20	30	30	35	35
NM8-400, 630, NM8S-400, 630	Ue ≥ 600V	30	30	30	35	35
	Ue ≤ 440V	10	30	30	60	60
	Ue < 600V	20	30	30	60	60
NM8-800, 1250, NM8S-800, 1250	Ue ≥ 600V	30	30	30	100	100
	S/H type	50	130	100	70	70

Nota: Cuando la tensión es ≥ 500V, deben montarse cubrebornes sobre los terminales

8.5 Modos de conexión

8.5.1 Conexión por terminal o pletina de cobre

a. Los tornillos suministrados admiten terminales de cobre o aluminio y pletinas de cobre

Tipo de tornillos:

- * NM8-125 : M6
- * NM8S-125, NM8-250, NM8S-250 : M8
- * NM8-400, NM8S-400, NM8-630, NM8S630 : M10
- * NM8-800S, NM8S-800, NM8-1250, NM8S-1250 : M10

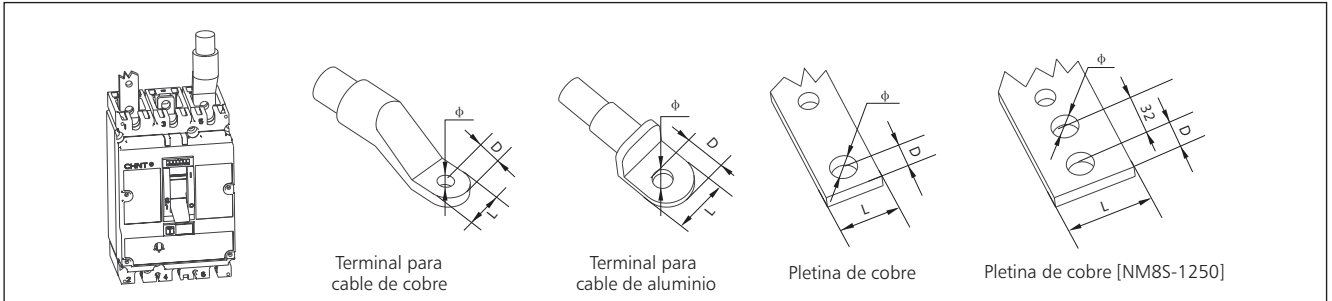

Interrupedores NM8(S)	NM8-125	NM8S-125 NM8-250 NM8S-250	NM8-400, 630 NM8S-400, 630	NM8-800, 1250 NM8S-800, 1250
Distancia entre polos (en mm)	30	35	45	70
L(mm)	≤ 15	≤ 25	≤ 32	≤ 50
D(mm)	≤ 7	≤ 10	≤ 16	≤ 16
φ (mm)	>6	>8	>10	>11

b. Con conexión frontal, los tornillos suministrados admiten terminales de cobre o aluminio y pletinas de cobre

Tipo de tornillos:

- * NM8-125 : M6
- * NM8S-125, NM8-250, NM8S-250 : M8
- * NM8-400, NM8S-400, NM8-630, NM8S630 : M12
- * NM8-800S, NM8S-800, NM8-1250, NM8S-1250 : M10

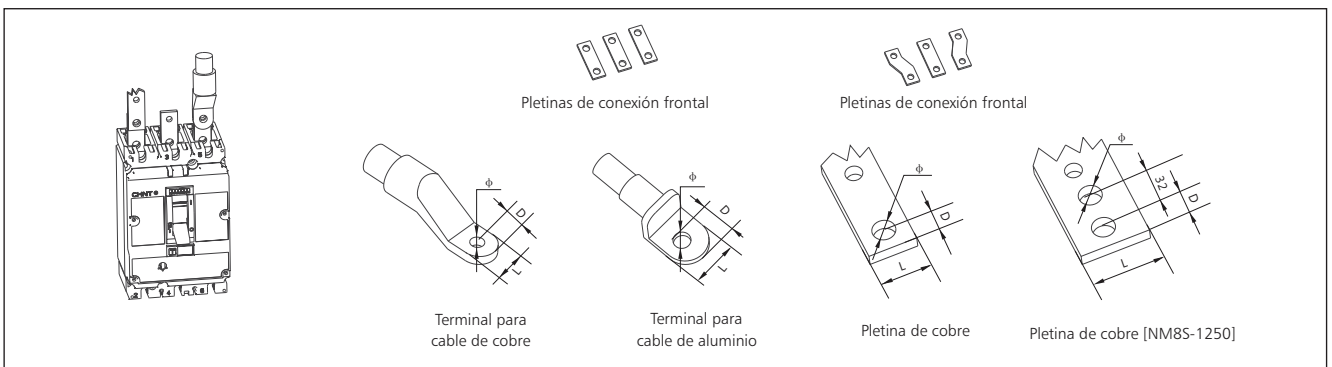

Interruptores NM8(S)	NM8-125	NM8S-125 NM8-250 NM8S-250	NM8-400, 630 NM8S-400, 630		NM8-800, 1250 NM8S-800, 1250
Distancia entre polos (en mm)	30	35	52.5	70	70
L(mm)	≤ 15	≤ 25	≤ 40	≤ 60	≤ 50
D(mm)	≤ 7	≤ 10	≤ 20	≤ 20	≤ 16
φ (mm)	>6	>8	>12	>12	>11

8.5.2 Terminales de conexión para cable

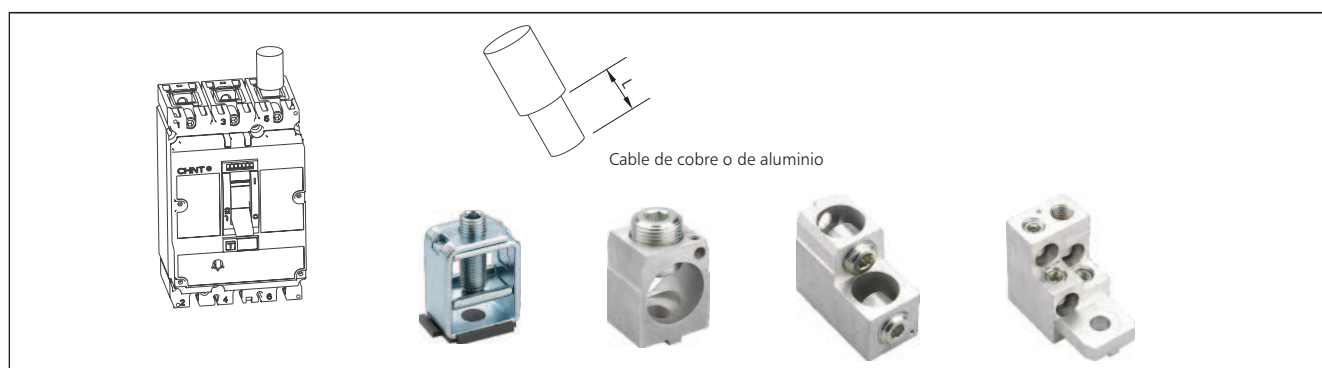

NM8	NM8-125	NM8S-125 NM8-250 NM8S-250
L(mm)	16	20
CSA(mm ²)	2.5~70	2.5~185

Interruptores NM8(S)	NM8-400, 630 NM8S-400, 630		
Número de cables	1	2	4
L(mm)	26	30, 60	30
Sección (mm ²)	35~370	35~185	35~125

8.5.3 Conexión Posterior

Para conexión posterior, el terminal a usar debe ser para conexiones con pletina de cobre.

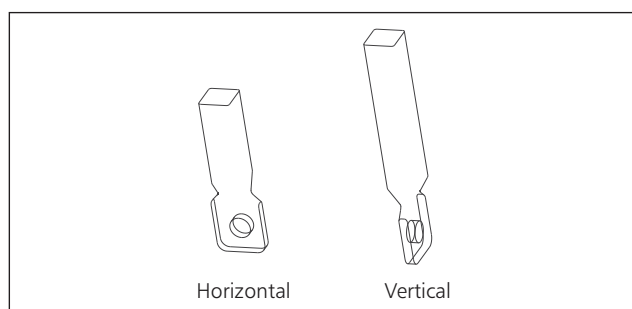

8.5.4 Base enchufable

La base enchufable puede ser de dos tipos: con conexión anterior y con conexión posterior.

Para la conexión posterior las pletinas pueden situarse en la parte anterior o en la parte posterior de la base.

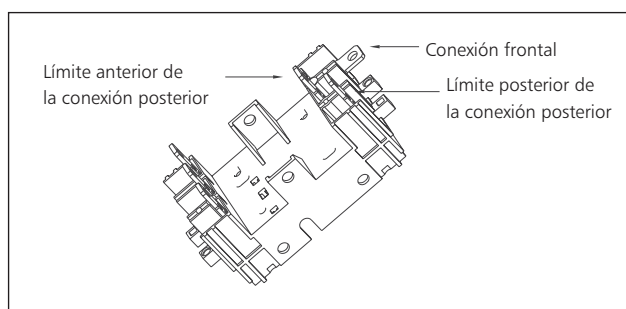

8.5.5 Secciones estandar de cable y/o pletina usadas para la conexión

Corriente nominal (A)		16	20	25	32	40	50	63	80	100	125	160	200	250	315	350	400	500	630	700	800	1000	1250
Sección (mm ²)	Cable de cobre	2.5	2.5	4.0	6.0	10	10	16	25	35	50	70	95	120	185	185	240	2×150	2×185	2×240	2×240	-	-
	Pletina de cobre	-	-	-	-	-	-	-	-	-	-	-	-	-	-	-	-	2×30×5	2×40×5	2×50×5	2×50×5	2×60×5	2×70×5

8.5.6 Secciones más usuales de conductores de acuerdo con la corriente

In(A)	Conductores de cobre		Pletinas flexibles	
	Sección (mm ²)		Sección (mm ²)	
10	1.5		—	
16	2.5		—	
20	2.5		—	
25	4		—	
32	6		—	
40	10		—	
63	16		—	
80	25		—	
100	35		—	
125	50		—	
160	70		—	
200	95		—	
250	120		—	
315	185		—	
400	240		—	
500	2×150		2×30×5	
630	2×185		2×40×5	
800	2×240		2×50×5	
1000	—		2×60×5	
1250	—		2×80×5	

8.6 Dimensiones exteriores

8.6.1 Conexión frontal

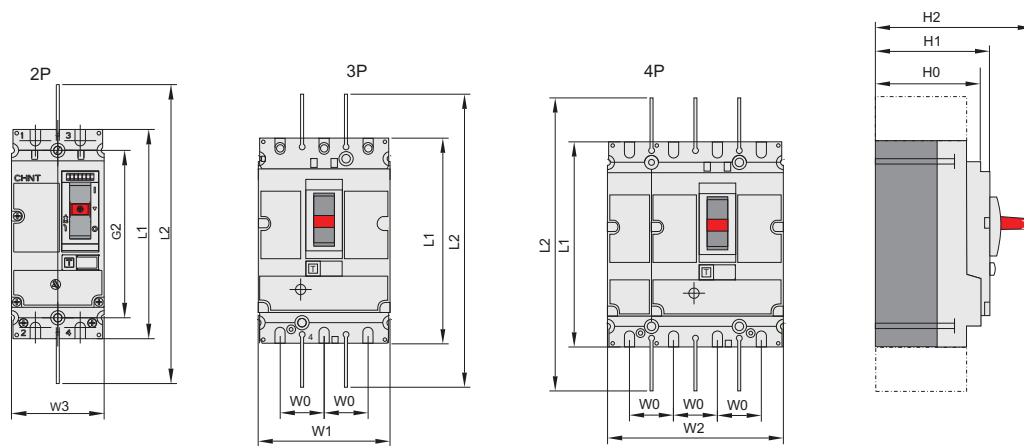

Montaje sobre placa

Montaje sobre perfiles

Montaje sobre guia Din (NM8S-125 - NM8S-250)

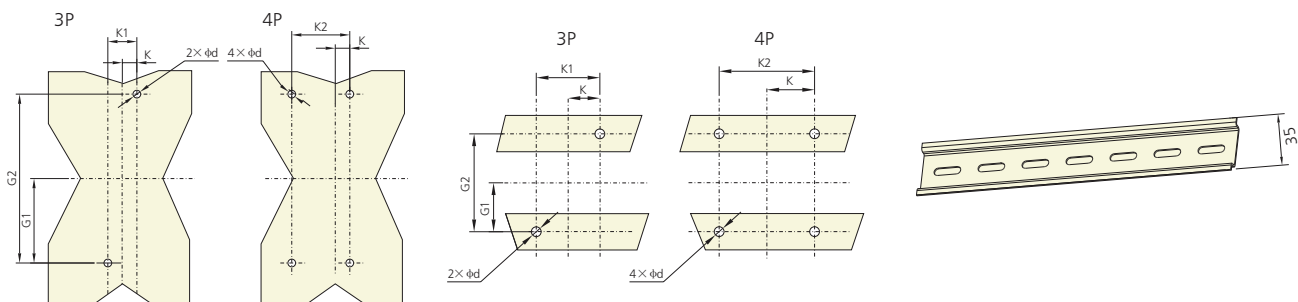

(mm)

Modelo	L1	L2	H0	H1	H2	K	K1	K2	G1	G2	W0	W1	W2	W3	d
NM8-125	140	240	72	79	103	15	30	60	56	112	30	90	120	62	6
NM8S-125/NM8-250/NM8S-250	157	357	82	88	126	17.5	35	70	62.5	125	35	105	140	70	6
NM8-400, 630/NM8S-400, 630	255	474	95	113	168	22.5	45	90	100	200	45	140	185	-	6
NM8-800, 1250/NM8S-800, 1250	370	570	132	144	206	35	70	140	120	240	70	210	280	-	7

8.6.2 Conexión posterior

Montaje sobre placa

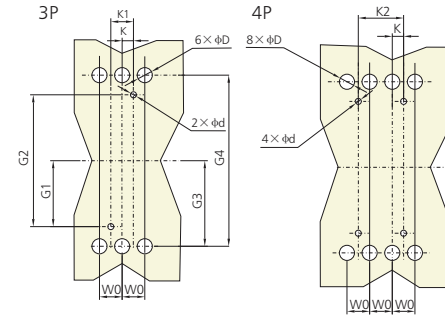
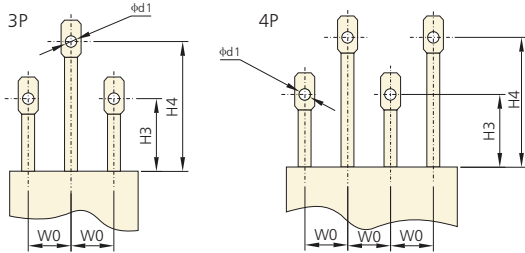

(mm)

Modelo	H3	H4	W0	K	K1	K2	G1	G2	G3	G4	d	d1	D
NM8-125	47	87	30	15	30	60	56	112	62.5	125	6	6	15
NM8S-125/NM8-250/NM8S-250	57	97	35	17.5	35	70	62.5	125	72	144	6	8	20
NM8-400/NM8S-400	56	100	45	22.5	45	90	100	200	113.5	227	6	13	32
NM8-630/NM8S-630	56	100	45	22.5	45	90	100	200	113.5	227	6	13	32

8.6.3 Conexión enchufable

Montaje sobre placa

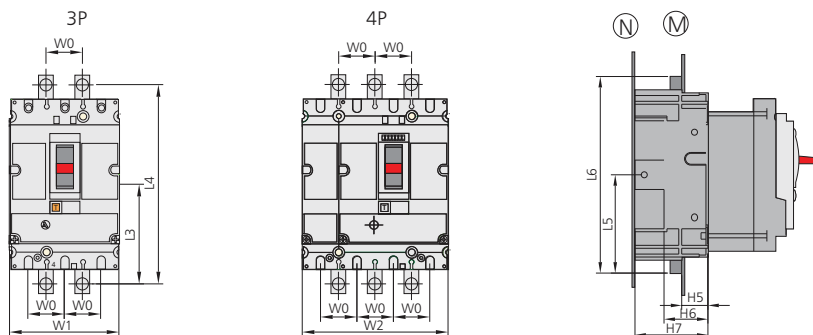

Montaje sobre placa

Montaje sobre pletinas

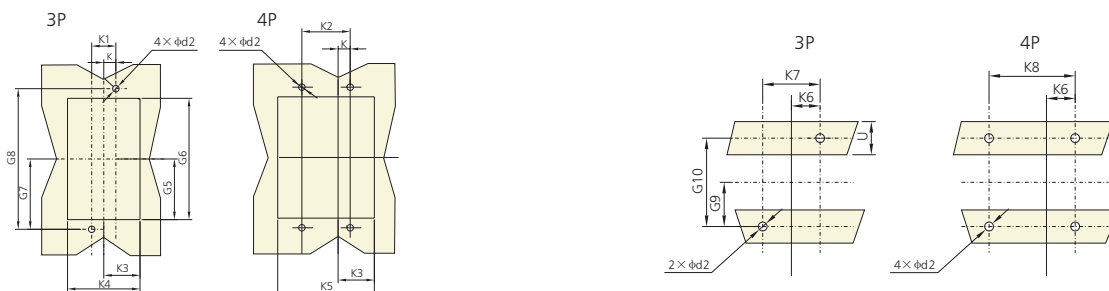

Montaje sobre placa **(M)** Conexión frontal
Debe montarse una barrera aislante entre la placa de montaje y la base enchufable.

Montaje sobre placa **(M)** Conexión frontal
Debe montarse una barrera aislante entre la placa de montaje y la base enchufable.

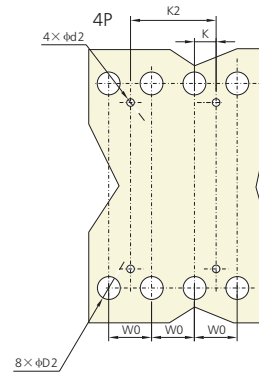
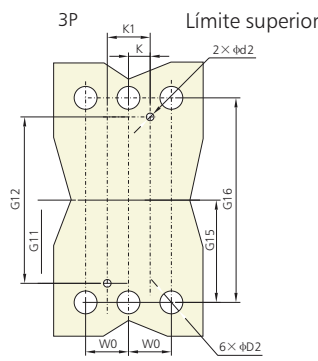
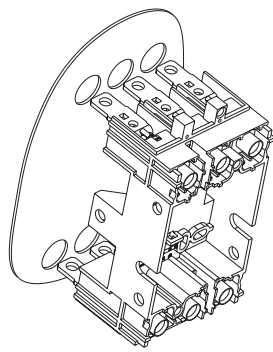
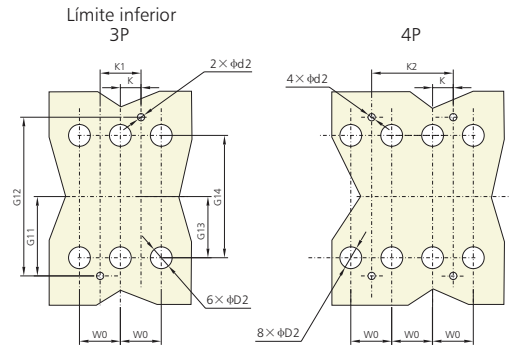
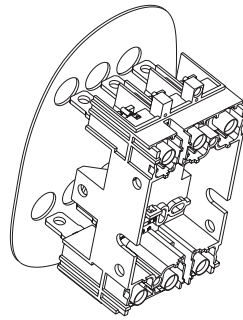
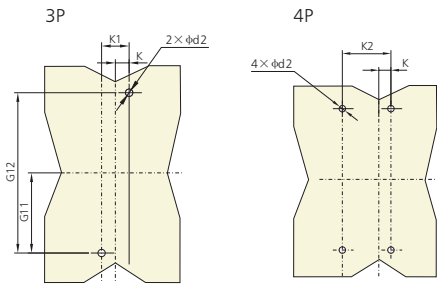

(mm)

Modelo	W0	W1	W2	L5	L6	H5	H6	H7	K	K1	K2	K3	K4	K5	K6	K7
NM8-125	30	90	120	90	180	24	40	67	15	30	60	47	94	124	30	60
NM8S-125/NM8-250/NM8S-250	35	105	140	102.5	205	27	45	75	17.5	35	70	54.5	109	144	35	70
NM8-400, 630/NM8S-400, 630	45	140	185	157.5	315	27	45	45	22.5	45	90	71.5	143	188	45	90

Modelo	K8	G5	G6	G7	G8	G9	G10	G11	G12	G13	G14	G15	G16	d2	D2	U
NM8-125	90	77	154	85.2	170.4	32.5	65	68	136	54.5	109	70.5	141	6	26	≤32
NM8S-125/NM8-250/NM8S-250	105	87	174	95	190	37.5	75	77.5	155	61	122	79	158	6	30	≤32
NM8-400, 630/NM8S-400, 630	140	137	274	150	300	75	150	125	250	100	200	126	252	6	33	≤32

8.6.4 Empotrar (tipos fijo o extraíble)

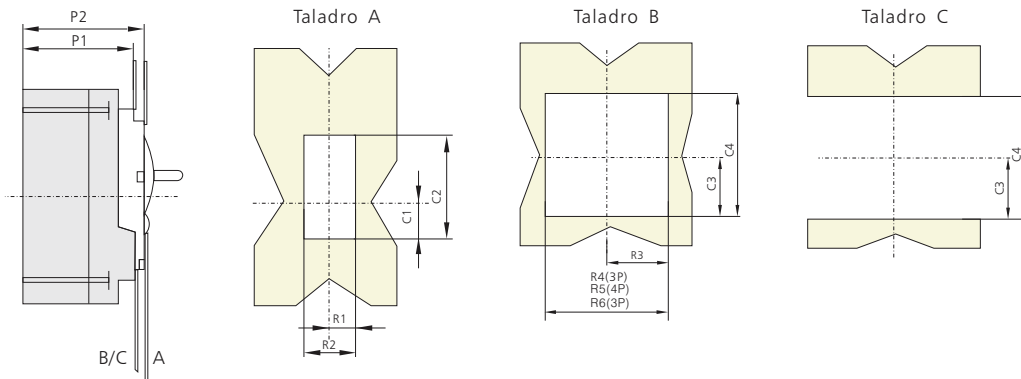

(mm)

Modelo	P1	P2	R1	R2	R3	R4	R5	R6	C1	C2	C3	C4
NM8-125	73	80	13	26	46.5	93	123	65	26	68	50.5	101
NM8S-125/NM8-250/NM8S-250	83	90	14.5	29	54	108	143	73	33	78	56.5	113
NM8-400, 630/NM8S-400, 630	109	114	26.5	53	71.5	143	188	-	41.5	116	108	205

9. Accesorios

9.1 Accesorios internos

9.1.1 Bobina de emisión de tensión

Tensión de trabajo: $U_s = 70 \sim 100\% U_n$

Nunca debe quedar alimentada permanentemente

Tiempo de respuesta: $\geq 20\text{ms} \sim \leq 60\text{ms}$

9.1.2 Bobina de mínima tensión

Tensión de trabajo: $U_s = 35 \sim 70\% U_n$

El interruptor abre con seguridad: $U_s \geq 85\% U_n$

El interruptor no cerrará con: $U_s < 35\% U_n$

Nota: Con tensión de alimentación $U_s \geq 85\% U_n$, el interruptor abre y cierra con toda garantía.

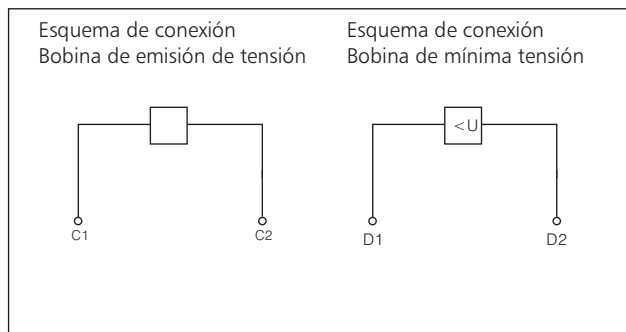

9.1.3 Contacto auxiliar

Indicación del estado de los contactos del interruptor

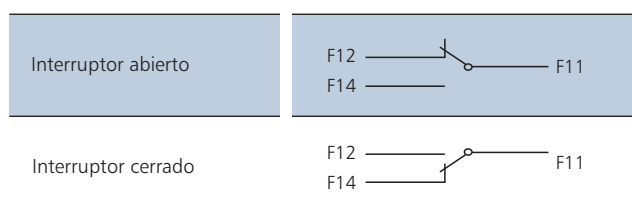

Esquema de conexión

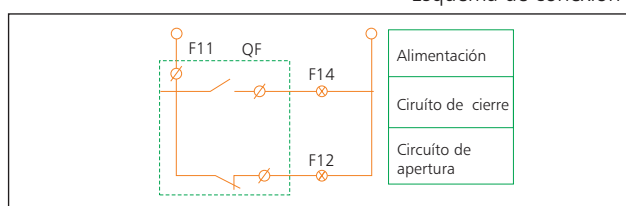

9.1.4 Contacto de alarma

Indicación del motivo de la desconexión del interruptor

- * Sobrecarga
- * Cortocircuito
- * Defecto a tierra
- * Mínima tensión

Cuando el interruptor abre y cierra normalmente (manualmente), el contacto de alarma no trabaja.

Después de una desconexión debida a un defecto el contacto de alarma indica esta anomalía. El contacto de alarma se recupera automáticamente cuando se opera de nuevo la maneta del interruptor.

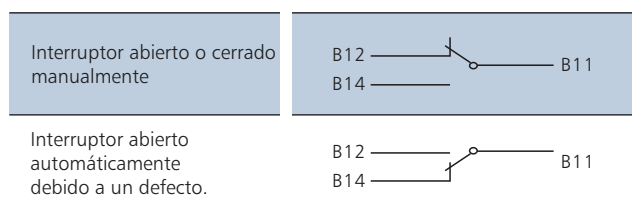

Esquema de conexión

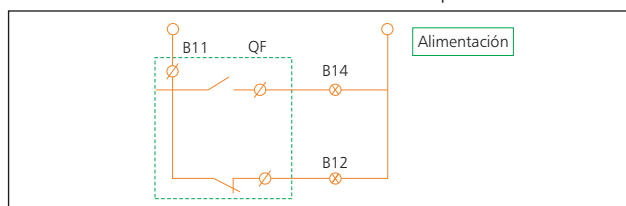

Accesorio	Características	Orden de montaje		
		NM8-125, 250 NM8S-125, 250	NM8-400, 630 NM8S-400, 630	NM8-800, 1250 NM8S-800, 1250
		3P, 4P	3P, 4P	3P, 4P
Sin accesorios				
Contacto de alarma	AL			
Bobina de emisión de tensión	SM: 220Vca, SQ: 380Vca SB: 24Vcc			
Contacto auxiliar	AX			
Bobina de mínima tensión	UM: 220Vca UQ: 380Vca			
Bobina de emisión de tensión Contacto auxiliar	SM: 220Vca, SQ: 380Vca, SB: 24Vcc AX			
2 grupos Contacto auxiliares	AX, AX			
Contacto auxiliar Bobina de mínima tensión	AX UM: 220Vca, UQ: 380Vca			
Bobina de emisión de tensión Contacto de alarma	SM: 220Vca, SQ: 380Vca, SB: 24Vcc AL			
Contacto auxiliar Contacto de alarma	AX AL			
Contacto de alarma Bobina de mínima tensión	AL			
Bobina de emisión de tensión Contactos auxiliar+alarma				
Contacto auxiliar (2 grupos) Contacto de alarma	AX, AX AL			
Contacto de alarma Contacto auxiliar Bobina de mínima tensión	AX, AL (UM: 220Vca, UQ: 380Vca)			

■ Bobina de emisión de tensión ▲ Bobina de mínima tensión ○ Contacto auxiliar ● Contacto de alarma

Nota: 1: Los interruptores NM8(S)-125, 250, 400, 630 no pueden equiparse simultáneamente con bobina de emisión de tensión y bobina de mínima tensión.

2: Los interruptores NM8(S)-800, 1250, pueden equiparse con un máximo de tres contactos auxiliares.

Puede montarseles simultáneamente bobina de emisión de tensión y bobina de mínima tensión y, además, ambas permiten ser intercambiadas de lado en el interruptor.

9.2 Accesorios externos

9.2.1 Mando rotativo con eje prolongado

Grado de protección: IP30

Funciones: Indicado para aislamiento;

0 (abierto), 1 (cerrado), Libre (interruptor disparado);

En la posición "OFF" (abierto), el mando puede ser equipado con 1, 2 o 3 candados de diámetros entre 5 y 8mm

Este mando impide que la puerta del cuadro eléctrico pueda ser abierta con el interruptor en posición "ON" (cerrado).

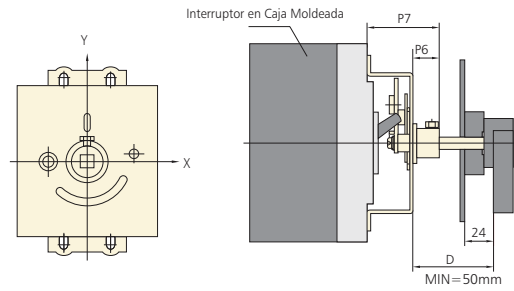

(mm)

Dimensiones	NM8-125	NM8S-125, NM8-250, NM8S-250	NM8-400, NM8S-400	NM8-630, NM8S-630
P6	14	14	20	20
P7	56	56	60	60

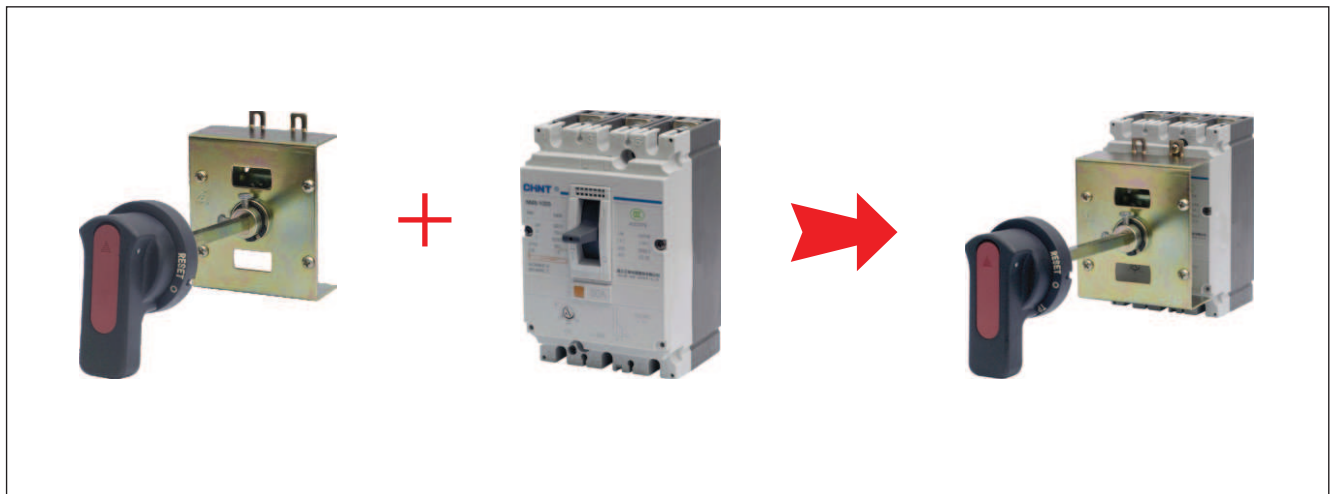

Taladro de montaje (mm)

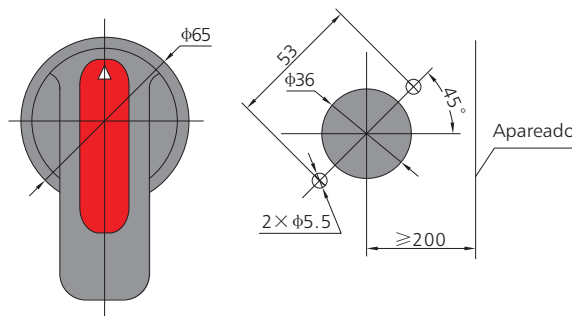

9.2.2 Mando rotativo directo

Grado de protección : IP40

Funciones: Elevado aislamiento;

0 (abierto), 1 (cerrado), Libre (interruptor disparado);

En la posición "OFF" (abierto), el mando puede ser equipado con 1, 2 o 3 candados de diámetros entre 5 y 8 mm.



Mando rotativo directo

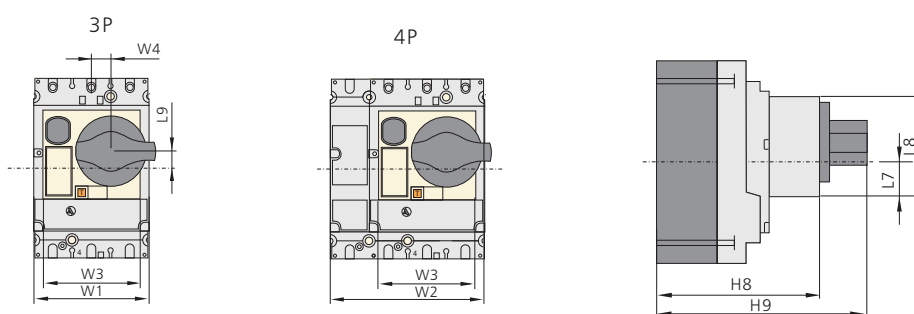

Taladro de montaje (mm)
 para interruptores fijos o enchufables



9.2.3 Mando rotativo con eje prolongado
Grado de protección: IP55

Funciones: Elevado aislamiento;
0 (abierto), 1 (cerrado), Libre (interruptor disparado);
En la posición "OFF" (abierto), el mando puede ser equipado con 1, 2 o 3 candados de diámetros entre 5 y 8 mm.
Este mando impide que la puerta del cuadro eléctrico pueda ser abierta con el interruptor en posición "ON" (cerrado)



Taladro de montaje (mm)
para interruptores fijos o enchufables

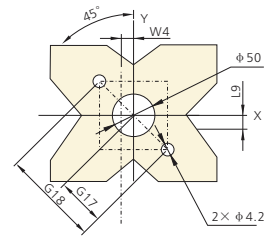
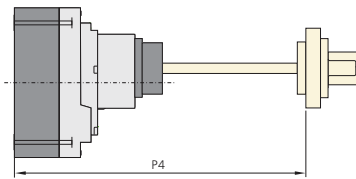

(mm)

Modelo	W1	W2	W3	W4	L7	L8	L9	H8	H9	P3	P4	R6	R7	C5	C6	G17	G18
NM8-125	30	90	76	15.25	37	70	13.3	114	148	80	≥175 ≤600	39	78	38	72	36	72
NM8S-125																	
NM8-250	35	105	93	9.25	39	73	9	125	159	90	≥175 ≤600	48	96	40.5	76	36	72
NM8S-250																	
NM8-400	45	140	122	5	69	121	24.5	148	198	115	≥175 ≤600	62	124	70.5	124	36	72
NM8S-400																	
NM8-630	45	140	122	5	69	121	24.5	148	198	115	≥175 ≤600	62	124	70.5	124	36	72
NM8S-630																	

9.2.4 Mando motor

Grado de protección: IP40

Funciones: Elevado aislamiento,

0 (abierto), 1 (cerrado), Libre (interruptor disparado);

Desconexión libre del interruptor;

Cierre o apertura del interruptor manual o automática

Manual

Situarse el conmutador "manual/auto" en posición "auto" y girar el mando para cerrar y abrir el interruptor.

Automatico

Situarse el conmutador "manual/auto" en posición "manual" y pulsar el botón de cierre y apertura para accionar el interruptor remotamente.

La operación de cierre y apertura puede realizarse mediante un impulso o autoretenición.

Rango de tensiones de trabajo: 85%Un~110%Un.



Interruptor	Tensión nominal	Vida eléctrica	Corriente de trabajo	Consumo	
NM8-125	100-240V AC	10,000 operaciones	≤0.5 A	14VA	
	100-220V DC			14W	
NM8S-125	100-240V AC	10,000 operaciones	≤0.5 A	14VA	
	100-220V DC			14W	
NM8S-250	100-240V AC	10,000 operaciones	≤0.5 A	14VA	
	100-220V DC			14W	
NM8-400	230V AC	5,000 operaciones	≤2 A	35VA	
	110V AC			35VA	
NM8S-400	220V DC	5,000 operaciones	≤2 A	35W	
	110V DC			35W	
NM8-630	220V DC	5,000 operaciones	≤2 A	35W	
	110V DC			35W	
NM8S-630	24V DC	5,000 operaciones	≤2 A	35W	
	24V DC			35W	
NM8-800	230V/400V AC	3,000 operaciones	≤7.5 A	200W	
				NM8S-800	200W
				NM8S-1250	200W

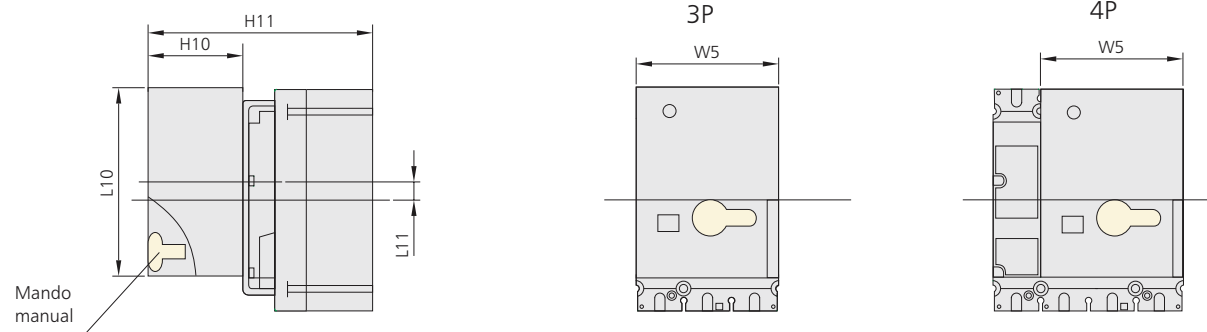

Taladro frontal (interruptores fijos o extraíbles)

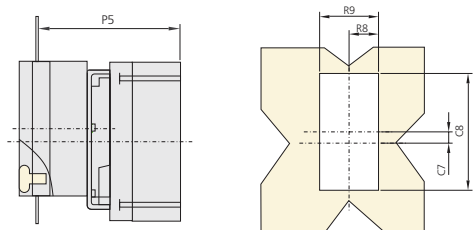

Esquema eléctrico

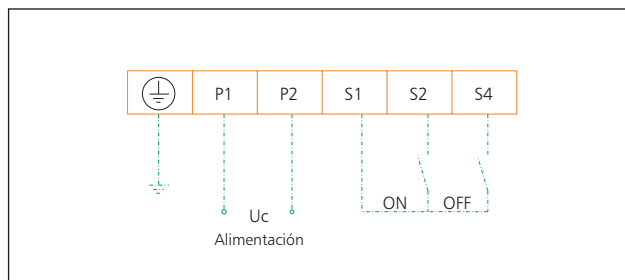

(mm)

Modelo	W5	H10	H11	L10	L11	R8	R9	P5	C7	C8
NM8-125	90	77	164	117	17.3	46.5	93	144	17.3	120
NM8S-125, NM8-250, NM8S-250	90	77	175	117	14.5	46.5	93	155	14.5	120
NM8-400, NM8S-400	107	115	250	174	19	64	128	225	19	177
NM8-630, NM8S-630	107	115	250	174	19	64	128	225	19	177
NM8-800, NM8S-800	-	-	-	-	-	-	-	-	-	-
NM8-1250, NM8S-1250	-	-	-	-	-	-	-	-	-	-

9.3 Sistema de bloqueo por candados

Bloqueo del interruptor en las posiciones abierto o cerrado. El sistema admite de 1 a 3 candados de diámetro entre 5 y 8mm (candados no incluidos).

9.4 Cubrebornes

Grado de protección: IP40

Protección contra contactos directos

Selección del cubrebornes:

- Interruptores fijos (conexión frontal): Cubrebornes largo
- Interruptores fijos (conexión posterior): Cubrebornes corto
- Interruptores enchufables: Cubrebornes corto

Cuando la tensión sea $\geq 500V$, debe seleccionarse en cubrebornes en función del tipo de conexión

Sistema de bloqueo por candados

Cubrebornes largo

Cubrebornes corto

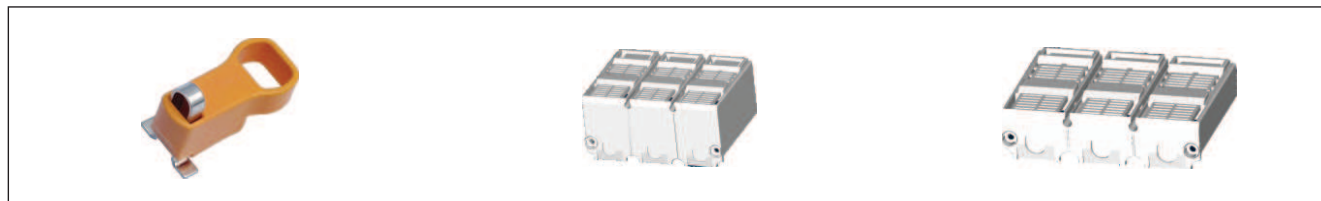

10. Información técnica complementaria

10.1 Función de aislamiento

- Las funciones de aislamiento de todos los interruptores automáticos quedan definidas en la norma UNE-EN60947-2

- La posición de aislamiento de los contactos es en 0 (OFF-ABIERTO)

- El mando de los aparatos debe indicar correctamente la posición 0 (OFF-ABIERTO) únicamente si el interruptor está abierto.

- El bloqueo por candados debe montarse con los contactos abiertos

- Las funciones de aislamiento deben contener los puntos siguientes:

- El aparato debe indicar correctamente la posición del mecanismo interno y de los contactos
- No deben mantenerse corrientes residuales
- El aparato debe soportar elevados impulsos de corriente puntuales en los lados de alimentación y de carga.

10.2 Limitación de corriente

10.2.1 Capacidad de limitación de corriente

La capacidad de limitación de corriente de un interruptor automático es su aptitud para limitar las corrientes de cortocircuito. Cuando se produce un cortocircuito el interruptor debe ser capaz de limitar la energía pasante (I^2t) en un tiempo lo más corto posible, para proteger las instalaciones aguas abajo del mismo.

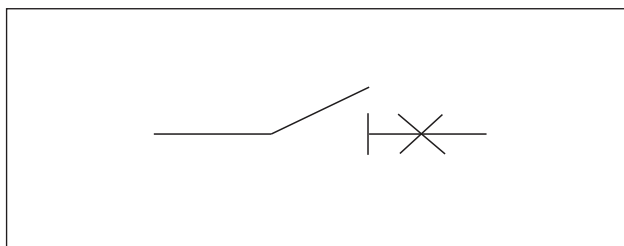

La excepcional capacidad de limitación de la corriente:

- Permite una elevada reducción de la potencia causada por la sobrecorriente y, como consecuencia, una alta capacidad de apertura siendo: $I_{cs} = 100\% I_{cu}$
- Evita daños en el aparato producidos por los cortocircuitos
- Evita el incremento de temperatura lo cual redundará en una mayor vida efectiva del cable.
- Reduce distorsiones de los contactos y de las barras de conexión.
- Reduce las intervenciones de los aparatos vecinos.

10.2.2 Curvas de limitación de corriente

La capacidad de limitación de corriente de un interruptor viene expresada por dos curvas las cuales indican la corriente prevista y la corriente de cortocircuito limitada.

El estrés térmico (A²S): por ejemplo, la energía disipada por el cortocircuito en un conductor con una resistencia de 1 ohmio.

La siguiente tabla indica el máximo estrés térmico permisible para cables, dependiendo del tipo de aislamiento tipo de conductor (Cu o Al) y sección.

Las secciones del cable se indican en mm² y el estrés térmico en A²S

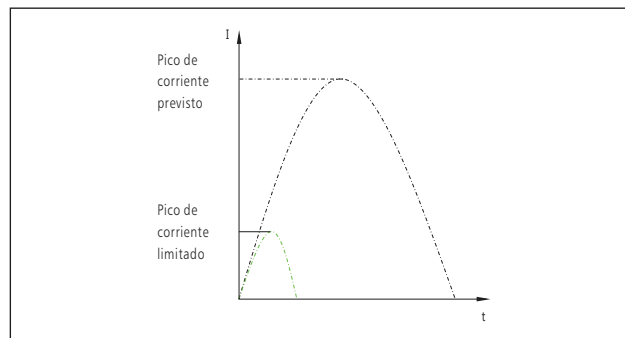

Sección (mm ²)		1.5	2.5	4	6	10	16	25	35
PVC	Cu K=115	2.97×10 ⁴	8.26×10 ⁴	2.12×10 ⁵	4.76×10 ⁵	1.32×10 ⁶	3.40×10 ⁶	8.26×10 ⁶	1.62×10 ⁷
	Al K=76	1.30×10 ⁴	3.61×10 ⁴	9.26×10 ⁴	2.08×10 ⁵	5.78×10 ⁵	1.48×10 ⁶	3.16×10 ⁶	7.08×10 ⁶
Goma butílica	Cu K=131	3.86×10 ⁴	1.07×10 ⁵	2.75×10 ⁵	6.18×10 ⁵	1.72×10 ⁶	4.39×10 ⁶	1.07×10 ⁷	2.10×10 ⁷
	Al K=87	1.70×10 ⁴	4.73×10 ⁴	1.21×10 ⁵	2.72×10 ⁵	7.57×10 ⁵	1.94×10 ⁶	4.73×10 ⁶	9.27×10 ⁶
Etileno-propileno	Cu K=143	4.60×10 ⁴	1.28×10 ⁵	3.27×10 ⁵	7.36×10 ⁵	2.04×10 ⁶	5.23×10 ⁶	1.28×10 ⁷	2.51×10 ⁷
	Al K=94	1.99×10 ⁴	5.52×10 ⁴	1.41×10 ⁵	3.18×10 ⁵	8.84×10 ⁵	2.26×10 ⁶	5.52×10 ⁶	1.08×10 ⁷

Sección (mm ²)		50	70	95	120	150	185	240
PVC	Cu K=115	3.31×10 ⁴	6.48×10 ⁴	1.19×10 ⁵	1.90×10 ⁵	2.98×10 ⁶	4.53×10 ⁶	7.62×10 ⁶
	Al K=76	1.44×10 ⁴	2.83×10 ⁴	5.21×10 ⁴	8.32×10 ⁴	1.30×10 ⁵	1.98×10 ⁶	3.33×10 ⁶
Goma butílica	Cu K=131	4.29×10 ⁴	8.41×10 ⁴	1.55×10 ⁵	2.47×10 ⁵	3.86×10 ⁵	5.87×10 ⁶	9.88×10 ⁶
	Al K=87	1.89×10 ⁴	3.71×10 ⁴	6.83×10 ⁴	1.09×10 ⁵	1.70×10 ⁵	2.59×10 ⁶	4.36×10 ⁶
Etileno-propileno	Cu K=143	5.11×10 ⁴	1.00×10 ⁵	1.85×10 ⁵	2.94×10 ⁵	4.60×10 ⁵	7.00×10 ⁶	1.18×10 ⁷
	Al K=94	2.21×10 ⁴	4.33×10 ⁴	7.97×10 ⁴	1.27×10 ⁵	1.99×10 ⁵	3.02×10 ⁶	5.09×10 ⁶

Ejemplo:

- a. Cual es la corriente actual cuando la corriente de cortocircuito prevista de 125kA (valor de pico=275kA) que fluye a través de un interruptor con limitación de corriente aguas arriba de un NM8-125R
 Respuesta: Valor de pico de 23kA (para mayores detalles, ver las curvas de limitación de corriente)
- b. Un cable de cobre con aislamiento de PVC, de 10mm de sección está adecuadamente protegido por un interruptor NM8-125S ?
 Respuesta: La tabla superior indica que el estrés térmico permisible es 1.32×10⁶ A²S en el punto donde un NM8S-125S (Icu=50kA) está instalado, y la corriente de cortocircuito queda limitada dentro del rango de 1.32×10 A²S, por lo tanto, el cable estará protegido.

Curva I² t

Curva A²s

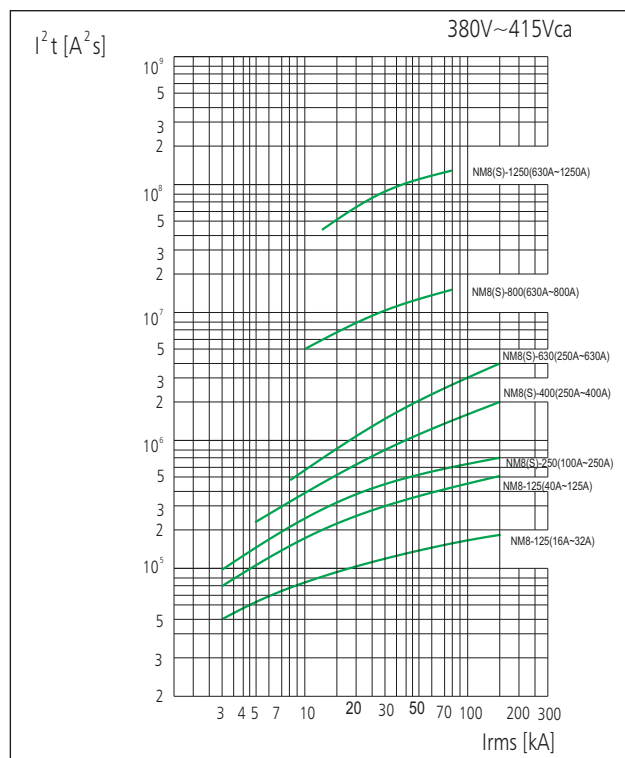
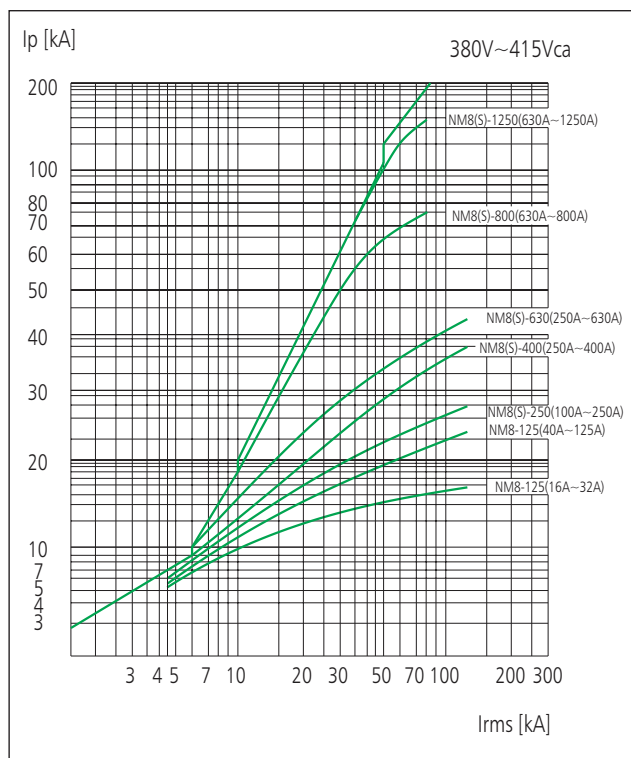

Curva I² t

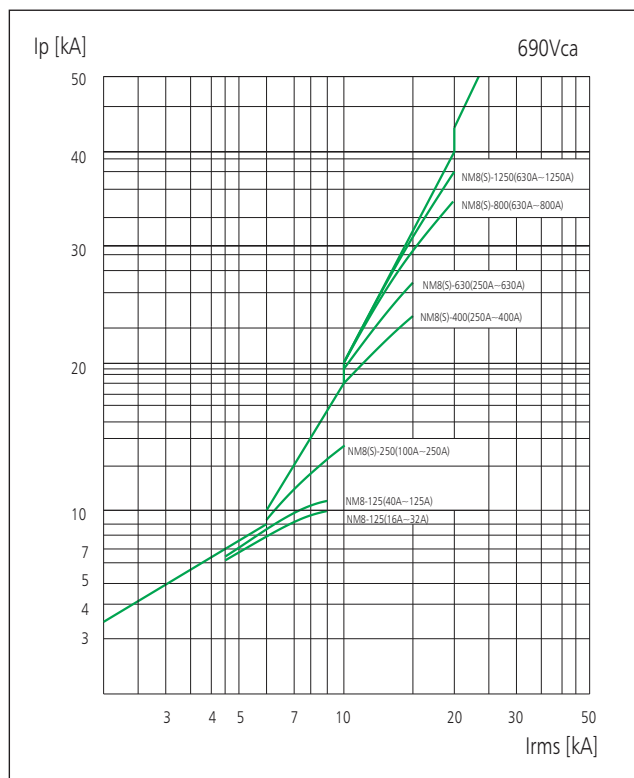

Curva A²s

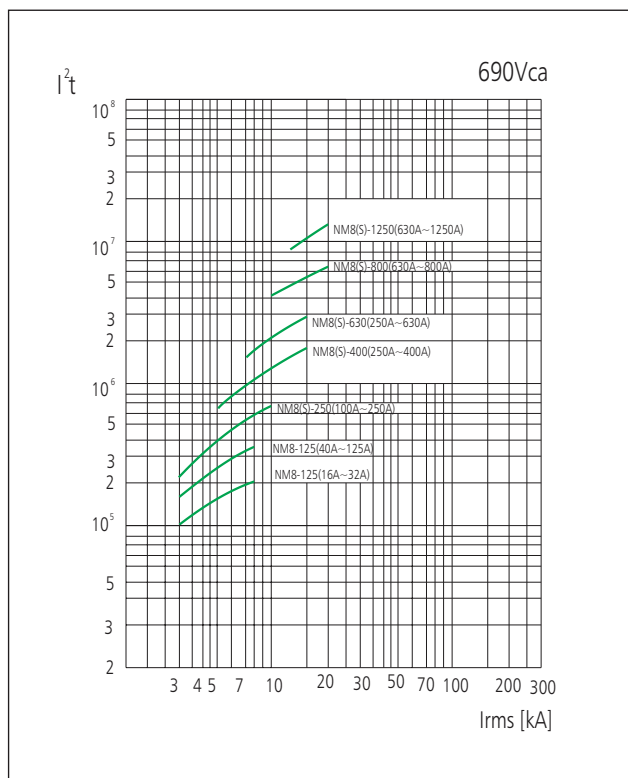

10.3 Pérdida de potencia por polo

Resistencia/Pérdida mΩ/W	NM8-125	NM8S-125	NM8-250	NM8S-250	NM8-400	NM8S-400	NM8-630	NM8S-630	NM8-800	NM8S-800	NM8-1250	NM8S-1250
16	7.1/1.8											
20	6.2/2.5											
25	4.8/3											
32	3.7/3.8											
40	2.6/4.2	0.85/1.4										
50	2.7/6.8	0.7/1.8										
63	1.7/6.7	0.7/2.8										
80	1.3/8.3	0.7/4.5										
100	0.85/8.5	0.5/5	1.0/10	0.5/5								
125	0.71/11.1	0.5/7.8	1.0/15.6	0.5/7.8								
160			0.55/14	0.36/9.2								
180			0.55/17.8	0.36/11.7								
200			0.55/22	0.36/14.4								
225			0.55/27.8	0.28/14.2								
250			0.55/34.4	0.28/17.5	0.3/18.8	0.15/9.4	0.3/18.8	0.13/8.1				
315					0.28/27.8	0.15/14.9	0.28/27.8	0.13/12.9				
350					0.28/34.3	0.15/18.4	0.28/34.3	0.13/15.9				
400					0.24/38.4	0.15/24	0.24/38.4	0.13/20.8				
500							0.2/50	0.13/32.5				
630								0.13/51.6	0.04/15.9	0.04/15.9	0.04/15.9	0.04/15.9
700									0.04/19.6	0.04/19.6	0.04/19.6	0.04/19.6
800									0.04/25.6	0.04/25.6	0.04/25.6	0.04/25.6
1000											0.04/40	0.04/40
1250											0.04/62.5	0.04/62.5

10.4 Influencia que la temperatura ejerce sobre las características de disparo

Las características del interruptor no sufren ninguna influencia cuando la altitud no excede de 2000m.

Cuando la altitud sobrepasa este nivel deben tomarse en consideración factores como la reducción del estrés dieléctrico y la temperatura ambiente.

Altitud (m)	2000	3000	4000	5000
Estrés dielectrico (V)	3000	2500	2100	1800
Tensión máxima de servicio (V)	690	550	480	420
Calibrado a 40°C (A)	1In	0.96In	0.93In	0.9In

10.5 Protección en cascada

Definición

La técnica de limitación de corriente ha sido adoptada para instalaciones en cascada.

Esta técnica permite instalar, aguas abajo del interruptor-limitador, interruptores de menor poder de corte (abaratando así las instalaciones), concediendo la capacidad de apertura a los interruptores NM8S los cuales trabajan como limitadores de la corriente de cortocircuito aguas arriba.

En protecciones en cascada en la red, los interruptores con menor capacidad de corte comparada con la corriente de cortocircuito prevista en un punto dado, pueden actuar bajo condiciones normales de cortocircuito. Cómo la corriente de cortocircuito quedará limitada aguas arriba por interruptor que actúe como limitador de corriente, puede aplicarse la protección en cascada a todos los aparatos instalados aguas abajo del mismo. Además, el trabajo en cascada permite la instalación de varios interruptores en serie siendo, además, aplicable a varios circuitos eléctricos.

Aplicación

Gracias a las protecciones en cascada, pueden instalarse aparatos en distintos cuadros de maniobra. Por lo tanto, al referirnos a una protección de este tipo estamos hablando de una combinación de interruptores instalados en una serie de puntos dados en los cuales la capacidad de corte es inferior a la corriente de cortocircuito prevista.

La capacidad de corte de los interruptores situados aguas arriba debe ser igual al mayor cortocircuito previsto.

Normativa

La protección en cascada está contemplada en la norma UNE-EN60947-2

Protección en Cascada (220/230/240V)

Aguas arriba: NM8-125~1250

Aguas abajo: eB, UB, DZ158, DZ267, NB1, NBH8, NM8(S)-125~1250

Aguas arriba Poder de corte (kA rms)	NM8-125S 85	NM8-125H 100	NM8-125R 150	NM8-250S 85	NM8-250H 100	NM8-250R 150	NM8-400S 85	
Aguas abajo	Poder de corte (kA rms)							
DZ267	30	80	80	30	40	40		
eB, UB	30	80	80	30	40	40		
NBH8	30	80	80	30	40	40		
NB1(Icn=6000A)	40	100	100	40	50	50		
NB1-63(Icn=10000A)	50	100	100	50	65	65		
DZ158-100	50	100	100	50	65	65	50	
NM8-125S		100	150		100	150		
NM8-125H			150			150		
NM8-250S					100	150		
NM8-250H						150		
NM8-400S								
NM8-400H								
NM8-630S								
NM8-630H								
NM8-800S								
NM8-800H								
NM8-1250S								
NM8-1250H								
NM8S-125S		100	150		100	150		
NM8S-125H			150			150		
NM8S-250S					100	150		
NM8S-250H						150		
NM8S-400S								
NM8S-400H								
NM8S-630S								
NM8S-630H								
NM8S-800S								
NM8S-800H								
NM8S-1250S								
NM8S-1250H								

NM8-400H 100	NM8-400R 150	NM8-630S 85	NM8-630H 100	NM8-630R 150	NM8-800S 65	NM8-800H 100	NM8-1250S 65	NM8-1250H 100
65	65							
100	150		100	150		100		100
	150			150				
100	150		100	150		100		100
	150			150				
100	150		100	150		100		100
	150			150				
			100	150		100		100
				150				
						100		100
						100		100
100	150		100	150		100		100
	150			150				
100	150		100	150		100		100
	150			150				
100	150		100	150		100		100
	150			150				
			100	150		100		100
				150				
						100		100
						100		100

Protección en Cascada (220/230/240V)

Aguas arriba: NM8S-125~1250

Aguas abajo: DZ267, eB, UB, NBH8, NB1, DZ158, NM8(S)-125~1250

Aguas arriba Poder de corte (kA rms) →	NM8S-125S 85	NM8S-125H 100	NM8S-250S 85	NM8S-250H 100	NM8S-400S 85	NM8S-400H 100	
Aguas abajo ↓	Poder de corte (kA rms)						
DZ267	30	80	30	40			
eB, UB	30	80	30	40			
NBH8	30	80	30	40			
NB1(Icn=6000A)	40	100	40	50			
NB1(Icn=10000A)	50	100	50	65			
DZ158-100	50	100	50	65	50	65	
NM8-125S		100		100		100	
NM8-125H							
NM8-250S				100		100	
NM8-250H							
NM8-400S						100	
NM8-400H							
NM8-630S							
NM8-630H							
NM8-800S							
NM8-800H							
NM8-1250S							
NM8-1250H							
NM8S-125S		100		100		100	
NM8S-125H							
NM8S-250S				100		100	
NM8S-250H							
NM8S-400S						100	
NM8S-400H							
NM8S-630S							
NM8S-630H							
NM8S-800S							
NM8S-800H							
NM8S-1250S							
NM8S-1250H							

NM8S-400R 150	NM8S-630S 85	NM8S-630H 100	NM8S-630R 150	NM8S-800S 65	NM8S-800H 100	NM8S-1250S 65	NM8S-1250H 100
65							
150							
150		100	150		100		100
150			150				
150		100	150		100		100
150			150				
150		100	150		100		100
			150				
		100	150		100		100
			150				
					100		100
					100		100
150							
150		100	150		100		100
150			150				
150		100	150		100		100
150			150				
150		100	150		100		100
			150				
		100	150		100		100
			150				
					100		100
					100		100

2. Protección en Cascada (380/400/415V)

Aguas arriba: NM8-125~1250;

Aguas abajo: eB, UB, DZ158, DZ267, NB1, NBH8, NM8(S)-125~1250

Aguas arriba Poder de corte (kA rms) →	NM8-125S 50	NM8-125H 100	NM8-125R 150	NM8-250S 50	NM8-250H 100	NM8-250R 150	NM8-400S 70
Aguas abajo ↓	Poder de corte (kA rms)						
eB, UB	15	20	20	15	20	20	
NB1 (I _{cn} =6000A)	25	30	30	25	30	30	
NB1-63 (I _{cn} =10000A)	25	40	40	25	40	40	
DZ158-100	25	40	40	25	40	40	25
NM8-125S		100	150		100	150	70
NM8-125H			150			150	
NM8-250S					100	150	70
NM8-250H						150	
NM8-400S							
NM8-400H							
NM8-630S							
NM8-630H							
NM8-800S							
NM8-800H							
NM8-1250S							
NM8-1250H							
NM8S-125S		100	150		100	150	70
NM8S-125H			150			150	
NM8S-250S					100	150	70
NM8S-250H						150	
NM8S-400S							
NM8S-400H							
NM8S-630S							
NM8S-630H							
NM8S-800S							
NM8S-800H							
NM8S-1250S							
NM8S-1250H							

NM8-400H 100	NM8-400R 150	NM8-630S 70	NM8-630H 100	NM8-630R 150	NM8-800S 50	NM8-800H 70	NM8-1250S 50	NM8-1250H 70
40	40							
100	150							
	150	70	100	150		70		70
100	150			150				
	150	70	100	150		70		70
100	150			150				
	150		100	150		70		70
				150				
			100	150		70		70
				150				
						70		70
100	150					70		70
	150	70	100	150		70		70
100	150			150				
	150	70	100	150		70		70
100	150			150				
	150		100	150		70		70
				150				
			100	150		70		70
				150				
						70		70
						70		70

Protección en Cascada (380/400/415V)

Aguas arriba: NM8S-125~1250

Aguas abajo: DZ267, eB, UB, NBH8, NB1, DZ158, NM8 (S) -125~1250

Aguas arriba Poder de corte (kA rms) →	NM8S-125S 50	NM8S-125H 100	NM8S-250S 50	NM8S-250H 100	NM8S-400S 70	NM8S-400H 100
Aguas abajo ↓	Poder de corte (kA rms)					
eB, UB	15	20	15	20		
NB1(Icn=6000A)	25	30	25	30		
NB1-63(Icn=10000A)	25	40	25	40		
DZ158	25	40	25	40	25	40
NM8-125S		100		100		100
NM8-125H				100		100
NM8-250S				100		100
NM8-250H						100
NM8-400S						100
NM8-400H						
NM8-630S						
NM8-630H						
NM8-800S						
NM8-800H						
NM8-1250S						
NM8-1250H						
NM8S-125S		100		100		100
NM8S-125H				100		100
NM8S-250S				100		100
NM8S-250H						100
NM8S-400S						100
NM8S-400H						
NM8S-630S						
NM8S-630H						
NM8S-800S						
NM8S-800H						
NM8S-1250S						
NM8S-1250H						

NM8S-400R 150	NM8S-630S 70	NM8S-630H 100	NM8S-630R 150	NM8S-800S 50	NM8S-800H 70	NM8S-1250S 50	NM8S-1250H 70
40							
150		100	150		70		70
150		100	150		70		70
150		100	150		70		70
150		100	150		70		70
150		100	150		70		70
150		100	150		70		70
		100	150		70		70
			150		70		70
					70		70
					70		70
					70		70
					70		70
150		100	150		70		70
150		100	150		70		70
150		100	150		70		70
150		100	150		70		70
150		100	150		70		70
150		100	150		70		70
		100	150		70		70
			150		70		70
					70		70
					70		70
					70		70
					70		70

10.6 Protección por Discriminación (Selectividad)

La protección por discriminación o selectividad es uno de los principales factores a tener en cuenta en el diseño de sistemas de distribución para garantizar la fiabilidad y continuidad de las instalaciones eléctricas.

Siempre que se produce un defecto en una red eléctrica, el interruptor aguas abajo del lugar donde se ha producido el defecto desconectará.

La protección por discriminación puede clasificarse en 3 tipos: discriminación total, discriminación parcial y no discriminación (ver las figura siguiente).

Discriminación Total: Para todo tipo de corrientes existentes en el lugar del defecto, incluyendo la corriente de sobrecarga, corrientes no resistivas, etc. abrirá el interruptor D2 y el D1 permanecerá cerrado

Discriminación Parcial: Para una corriente mucho menor en el lugar donde ocurrió la avería que el valor límite de la protección por discriminación, abrirá el interruptor D2 y el interruptor D1 permanecerá cerrado (discriminación total)

No Discriminación: Cuando la corriente del defecto es menor que el valor límite de la protección por discriminación, los interruptores aguas arriba y aguas abajo son aplicables a este tipo de protección.
Cuando la corriente del defecto excede el valor límite de la protección por discriminación, los interruptores aguas arriba y aguas abajo NO son aplicables a este tipo de protección; en este caso ambos interruptores, D1 y D2 desconectarán al mismo tiempo.

Aguas arriba: NM8-125~1250

Aguas abajo: DZ267, eB, UB, NBH8, NB1, DZ158

		NM8-125 S/H/R										NM8-250 S/H/R			
		16	20	25	32	40	50	63	80	100	125	100	160	200	250
DZ267 C Curvas	≤10	0.19	0.25	0.3	0.4	0.5	0.5	0.5	0.63	0.8	1.0	T	T	T	T
	16			0.3	0.4	0.5	0.5	0.5	0.63	0.8	1.0	T	T	T	T
	20					0.5	0.5	0.5	0.63	0.8	1.0	T	T	T	T
	25						0.5	0.5	0.63	0.8	1.0	T	T	T	T
	32							0.5	0.63	0.8	1.0	T	T	T	T
eB, UB C Curvas	≤10	0.19	0.25	0.3	0.4	0.5	0.5	0.5	0.63	0.8	1.0	T	T	T	T
	16			0.3	0.4	0.5	0.5	0.5	0.63	0.8	1.0	T	T	T	T
	20					0.5	0.5	0.5	0.63	0.8	1.0	T	T	T	T
	25						0.5	0.5	0.63	0.8	1.0	T	T	T	T
	32							0.5	0.63	0.8	1.0	T	T	T	T
	40								0.63	0.8	1.0	T	T	T	T
	50									0.8	1.0	T	T	T	T
60										1.0	T	T	T	T	
NBH8 B C Curvas	≤10	0.19	0.25	0.3	0.4	0.5	0.5	0.5	0.63	0.8	1.0	T	T	T	T
	16			0.3	0.4	0.5	0.5	0.5	0.63	0.8	1.0	T	T	T	T
	20					0.5	0.5	0.5	0.63	0.8	1.0	T	T	T	T
	25						0.5	0.5	0.63	0.8	1.0	T	T	T	T
	32							0.5	0.63	0.8	1.0	T	T	T	T
NB1 B C D Curvas	≤10	0.19	0.25	0.3	0.4	0.5	0.5	0.5	0.63	0.8	1.0	T	T	T	T
	16			0.3	0.4	0.5	0.5	0.5	0.63	0.8	1.0	T	T	T	T
	20					0.5	0.5	0.5	0.63	0.8	1.0	T	T	T	T
	25						0.5	0.5	0.63	0.8	1.0	T	T	T	T
	32							0.5	0.63	0.8	1.0	T	T	T	T
	40								0.63	0.8	1.0	T	T	T	T
	50									0.8	1.0	T	T	T	T
DZ158	63									0.8	1.0	T	T	T	T
	80										1.0	T	T	T	T
	100											T	T	T	T

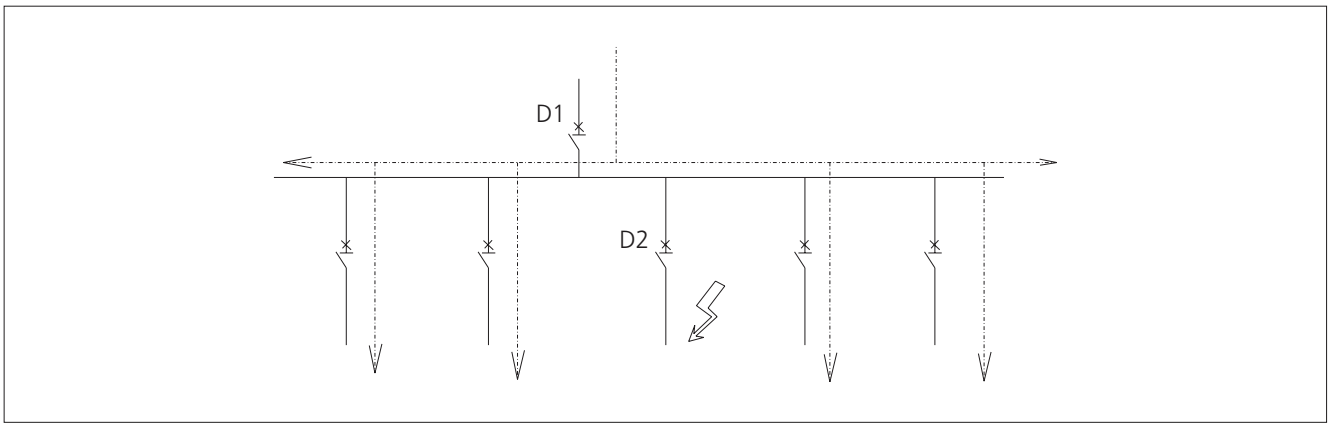

NM8-400 S/H/R				NM8-630 S/H/R					NM8-800 S/H			NM8-1250 S/H				
250	315	350	400	250	315	350	400	500	630	700	800	630	700	800	1000	1250
T	T	T	T	T	T	T	T	T	T	T	T	T	T	T	T	T
T	T	T	T	T	T	T	T	T	T	T	T	T	T	T	T	T
T	T	T	T	T	T	T	T	T	T	T	T	T	T	T	T	T
T	T	T	T	T	T	T	T	T	T	T	T	T	T	T	T	T
T	T	T	T	T	T	T	T	T	T	T	T	T	T	T	T	T
T	T	T	T	T	T	T	T	T	T	T	T	T	T	T	T	T
T	T	T	T	T	T	T	T	T	T	T	T	T	T	T	T	T
T	T	T	T	T	T	T	T	T	T	T	T	T	T	T	T	T
T	T	T	T	T	T	T	T	T	T	T	T	T	T	T	T	T
T	T	T	T	T	T	T	T	T	T	T	T	T	T	T	T	T
T	T	T	T	T	T	T	T	T	T	T	T	T	T	T	T	T
T	T	T	T	T	T	T	T	T	T	T	T	T	T	T	T	T
T	T	T	T	T	T	T	T	T	T	T	T	T	T	T	T	T
T	T	T	T	T	T	T	T	T	T	T	T	T	T	T	T	T
T	T	T	T	T	T	T	T	T	T	T	T	T	T	T	T	T
T	T	T	T	T	T	T	T	T	T	T	T	T	T	T	T	T
T	T	T	T	T	T	T	T	T	T	T	T	T	T	T	T	T
T	T	T	T	T	T	T	T	T	T	T	T	T	T	T	T	T
T	T	T	T	T	T	T	T	T	T	T	T	T	T	T	T	T
T	T	T	T	T	T	T	T	T	T	T	T	T	T	T	T	T
T	T	T	T	T	T	T	T	T	T	T	T	T	T	T	T	T
T	T	T	T	T	T	T	T	T	T	T	T	T	T	T	T	T
T	T	T	T	T	T	T	T	T	T	T	T	T	T	T	T	T

Aguas arriba: NM8S-125~1250

Aguas abajo: DZ267, eB, UB, NBH8, NB1, DZ158

		NM8S-125 S/H			NM8S-250 S/H				NM8S-400 S/H/R			
		40	100	125	100	160	200	250	250	315	350	400
DZ267 C Curvas	≤10	0.5	0.8	1.0	T	T	T	T	T	T	T	T
	16	0.5	0.8	1.0	T	T	T	T	T	T	T	T
	20	0.5	0.8	1.0	T	T	T	T	T	T	T	T
	25		0.8	1.0	T	T	T	T	T	T	T	T
	32		0.8	1.0	T	T	T	T	T	T	T	T
eB, UB C Curvas	≤10	0.5	0.8	1.0	T	T	T	T	T	T	T	T
	16	0.5	0.8	1.0	T	T	T	T	T	T	T	T
	20	0.5	0.8	1.0	T	T	T	T	T	T	T	T
	25		0.8	1.0	T	T	T	T	T	T	T	T
	32		0.8	1.0	T	T	T	T	T	T	T	T
	40		0.8	1.0	T	T	T	T	T	T	T	T
	50		0.8	1.0	T	T	T	T	T	T	T	T
NBH8 B C Curvas	≤10	0.5	0.8	1.0	T	T	T	T	T	T	T	T
	16	0.5	0.8	1.0	T	T	T	T	T	T	T	T
	20	0.5	0.8	1.0	T	T	T	T	T	T	T	T
	25		0.8	1.0	T	T	T	T	T	T	T	T
	32		0.8	1.0	T	T	T	T	T	T	T	T
NB1 B C D Curvas	≤10	0.5	0.8	1.0	T	T	T	T	T	T	T	T
	16	0.5	0.8	1.0	T	T	T	T	T	T	T	T
	20	0.5	0.8	1.0	T	T	T	T	T	T	T	T
	25		0.8	1.0	T	T	T	T	T	T	T	T
	32		0.8	1.0	T	T	T	T	T	T	T	T
	40		0.8	1.0	T	T	T	T	T	T	T	T
	50		0.8	1.0	T	T	T	T	T	T	T	T
DZ158	63		0.8	1.0	T	T	T	T	T	T	T	T
	80			1.0	T	T	T	T	T	T	T	T
	100					T	T	T	T	T	T	T
	63		0.8	1.0	T	T	T	T	T	T	T	T
	80			1.0	T	T	T	T	T	T	T	T
	100					T	T	T	T	T	T	T
	125					T	T	T	T	T	T	T

NM8S-630 S/H/R						NM8S-800 S/H			NM8S-1250 S/H				
250	315	350	400	500	630	630	700	800	630	700	800	1000	1250
T	T	T	T	T	T	T	T	T	T	T	T	T	T
T	T	T	T	T	T	T	T	T	T	T	T	T	T
T	T	T	T	T	T	T	T	T	T	T	T	T	T
T	T	T	T	T	T	T	T	T	T	T	T	T	T
T	T	T	T	T	T	T	T	T	T	T	T	T	T
T	T	T	T	T	T	T	T	T	T	T	T	T	T
T	T	T	T	T	T	T	T	T	T	T	T	T	T
T	T	T	T	T	T	T	T	T	T	T	T	T	T
T	T	T	T	T	T	T	T	T	T	T	T	T	T
T	T	T	T	T	T	T	T	T	T	T	T	T	T
T	T	T	T	T	T	T	T	T	T	T	T	T	T
T	T	T	T	T	T	T	T	T	T	T	T	T	T
T	T	T	T	T	T	T	T	T	T	T	T	T	T
T	T	T	T	T	T	T	T	T	T	T	T	T	T
T	T	T	T	T	T	T	T	T	T	T	T	T	T
T	T	T	T	T	T	T	T	T	T	T	T	T	T
T	T	T	T	T	T	T	T	T	T	T	T	T	T
T	T	T	T	T	T	T	T	T	T	T	T	T	T
T	T	T	T	T	T	T	T	T	T	T	T	T	T
T	T	T	T	T	T	T	T	T	T	T	T	T	T
T	T	T	T	T	T	T	T	T	T	T	T	T	T
T	T	T	T	T	T	T	T	T	T	T	T	T	T
T	T	T	T	T	T	T	T	T	T	T	T	T	T
T	T	T	T	T	T	T	T	T	T	T	T	T	T
T	T	T	T	T	T	T	T	T	T	T	T	T	T
T	T	T	T	T	T	T	T	T	T	T	T	T	T
T	T	T	T	T	T	T	T	T	T	T	T	T	T
T	T	T	T	T	T	T	T	T	T	T	T	T	T

Aguas arriba: NM8-125~1250
Aguas abajo: NM8(S)-125~1250

	In (A) Ii (kA)	NM8-125 S/H/R										NM8-250 S/H/R					
		16	20	25	32	40	50	63	80	100	125	100	160	200		250	
NM8-125 S	16				0.4	0.5	0.5	0.5	0.63	0.8	1.0	2.0	T	T	T		
	20					0.5	0.5	0.5	0.63	0.8	1.0	2.0	T	T	T		
	25						0.5	0.5	0.63	0.8	1.0	2.0	T	T	T		
	32							0.5	0.63	0.8	1.0	2.0	T	T	T		
	40								0.63	0.8	1.0	2.0	T	T	T		
	50									0.8	1.0	2.0	T	T	T		
	63										1.0	2.0	T	T	T		
	80												1.25	T	T		
	100												1.25	T	T		
	125															T	
NM8-125 H/R	16				0.4	0.5	0.5	0.5	0.63	0.8	1.0	2.0	T	T	T		
	20					0.5	0.5	0.5	0.63	0.8	1.0	2.0	T	T	T		
	25						0.5	0.5	0.63	0.8	1.0	2.0	T	T	T		
	32							0.5	0.63	0.8	1.0	2.0	T	T	T		
	40								0.63	0.8	1.0	2.0	3.6	3.6	3.6		
	50									0.8	1.0	2.0	3.6	3.6	3.6		
	63										1.0	2.0	3.6	3.6	3.6		
	80												3.6	3.6	3.6		
	100												3.6	3.6	3.6		
	125															3.6	
NM8S-125 S/H	40								0.63	0.8	1.0	1.25	T	T	T		
	100											1.25	T	T			
	125															2.5	
NM8-250 S	100																3
	160																
	200																
	250																
NM8-250 H/R	100																3
	160																
	200																
	250																
NM8S-250 S/H	100												1.6	2	2.5		
	160															2.5	
	200																
	250																
NM8-400 S/H/R	250																
	315																
	350																
	400																
NM8S-400 S/H/R	250																
	315																
	350																
	400																
NM8-630 S/H/R	250																
	315																
	350																
	400																
500																	

NM8-400 S/H/R				NM8-630 S/H/R					NM8-800 S/H			NM8-1250 S/H					
250	315	350	400	250	315	350	400	500	630	700	800	630	700	800	1000	1250	
T	T	T	T	T	T	T	T	T	T	T	T	T	T	T	T	T	
T	T	T	T	T	T	T	T	T	T	T	T	T	T	T	T	T	
T	T	T	T	T	T	T	T	T	T	T	T	T	T	T	T	T	
T	T	T	T	T	T	T	T	T	T	T	T	T	T	T	T	T	
T	T	T	T	T	T	T	T	T	T	T	T	T	T	T	T	T	
T	T	T	T	T	T	T	T	T	T	T	T	T	T	T	T	T	
T	T	T	T	T	T	T	T	T	T	T	T	T	T	T	T	T	
T	T	T	T	T	T	T	T	T	T	T	T	T	T	T	T	T	
T	T	T	T	T	T	T	T	T	T	T	T	T	T	T	T	T	
T	T	T	T	T	T	T	T	T	T	T	T	T	T	T	T	T	
T	T	T	T	T	T	T	T	T	50	50	50	50	50	50	50	T	T
T	T	T	T	T	T	T	T	T	50	50	50	50	50	50	50	T	T
T	T	T	T	T	T	T	T	T	50	50	50	50	50	50	50	T	T
T	T	T	T	T	T	T	T	T	50	50	50	50	50	50	50	T	T
T	T	T	T	T	T	T	T	T	50	50	50	50	50	50	50	T	T
T	T	T	T	T	T	T	T	T	50	50	50	50	50	50	50	T	T
T	T	T	T	T	T	T	T	T	50	50	50	50	50	50	50	T	T
T	T	T	T	T	T	T	T	T	50	50	50	50	50	50	50	T	T
T	T	T	T	T	T	T	T	T	50	50	50	50	50	50	50	T	T
T	T	T	T	T	T	T	T	T	50	50	50	50	50	50	50	T	T
T	T	T	T	T	T	T	T	T	50	50	50	50	50	50	50	T	T
T	T	T	T	T	T	T	T	T	50	50	50	50	50	50	50	T	T
T	T	T	T	T	T	T	T	T	50	50	50	50	50	50	50	T	T
T	T	T	T	T	T	T	T	T	50	50	50	50	50	50	50	T	T
T	T	T	T	T	T	T	T	T	50	50	50	50	50	50	50	T	T
T	T	T	T	T	T	T	T	T	50	50	50	50	50	50	50	T	T
T	T	T	T	T	T	T	T	T	50	50	50	50	50	50	50	T	T
T	T	T	T	T	T	T	T	T	50	50	50	50	50	50	50	T	T
T	T	T	T	T	T	T	T	T	50	50	50	50	50	50	50	T	T
5	T	T	T	3	T	T	T	T	T	T	T	T	T	T	T	T	T
	5	T	T		5	T	T	T	T	T	T	T	T	T	T	T	T
		5	T			5	T	T	T	T	T	T	T	T	T	T	T
			5				5	T	T	T	T	T	T	T	T	T	T
5		T	T	3	T	T	T	T	40	40	40	40	40	40	40	T	T
		T	T		5	T	T	T	40	40	40	40	40	40	40	T	T
		5	T			5	T	T	40	40	40	40	40	40	40	T	T
			5				5	T	40	40	40	40	40	40	40	T	T
5		5	5	T	T	T	T	T	T	T	T	T	T	T	T	T	T
5		5	5	T	T	T	T	T	T	T	T	T	T	T	T	T	T
		5	5				T	T	T	T	T	T	T	T	T	T	T
			5					T	T	T	T	T	T	T	T	T	T
							8	8	30	30	30	30	30	30	30	T	T
								8	30	30	30	30	30	30	30	T	T
									30	30	30	30	30	30	30	T	T
									30	30	30	30	30	30	30	T	T
							8	8	12	12	12	12	12	12	12	15	15
								8	12	12	12	12	12	12	12	15	15
									12	12	12	12	12	12	12	15	15
									12	12	12	12	12	12	12	15	15
							8	8	30	30	30	30	30	30	30	T	T
								8	30	30	30	30	30	30	30	T	T
									30	30	30	30	30	30	30	T	T
									30	30	30	30	30	30	30	T	T
										30	30	30	30	30	30	T	T

		NM8-125 S/H/R										NM8-250 S/H/R			
		16	20	25	32	40	50	63	80	100	125	100	160	200	250
NM8S-630 S/H/R	250														
	315														
	350														
	400														
	500														
NM8-800 S/H	630														
	700														
	800														
NM8S-800 S/H	630														
	700														
	800														
NM8-1250 S/H	630														
	700														
	800														
	1000														
	1250														
NM8S-1250 S/H	630														
	700														
	800														
	1000														
	1250														

Aguas arriba: NM8S-125~1250

Aguas abajo: NM8(S)-125~1250

		NM8S-125 S/H			NM8S-250 S/H				NM8S-400 S/H/R			
		40	100	125	100	160	200	250	250	315	350	400
NM8-125 S	16		1.2	1.2	1.2	T	T	T	T	T	T	T
	20		1.2	1.2	1.2	T	T	T	T	T	T	T
	25		1.2	1.2	1.2	T	T	T	T	T	T	T
	32		1.2	1.2	1.2	T	T	T	T	T	T	T
	40		1.2	1.2	1.2	T	T	T	T	T	T	T
	50		1.2	1.2	1.2	T	T	T	T	T	T	T
	63			1.2	1.2	T	T	T	T	T	T	T
	80					T	T	T	T	T	T	T
	100						T	T	T	T	T	T
NM8-125 H/R	16		1.2	1.2	1.2	T	T	T	T	T	T	T
	20		1.2	1.2	1.2	T	T	T	T	T	T	T
	25		1.2	1.2	1.2	T	T	T	T	T	T	T
	32		1.2	1.2	1.2	T	T	T	T	T	T	T
	40		1.2	1.2	1.2	T	T	T	T	T	T	T
	50		1.2	1.2	1.2	2	36	36	T	T	T	T
	63			1.2	1.2	2	36	36	T	T	T	T
	80					2	36	36	T	T	T	T
	100							36	T	T	T	T
NM8S-125 S/H	40		1.2	1.2	2	2	T	T	T	T	T	T
	100					2	T	T	T	T	T	T
	125							T	T	T	T	T

NM8-400 S/H/R				NM8-630 S/H/R					NM8-800 S/H			NM8-1250 S/H				
250	315	350	400	250	315	350	400	500	630	700	800	630	700	800	1000	1250
							8	8	12	12	12	12	12	12	15	15
								8	12	12	12	12	12	12	15	15
									12	12	12	12	12	12	15	15
									12	12	12	12	12	12	15	15
										12	12	12	12	12	15	15
											12			12	15	15
															15	15
															15	15
															15	15

NM8S-630 S/H/R						NM8S-800 S/H			NM8S-1250 S/H				
250	315	350	400	500	630	630	700	800	630	700	800	1000	1250
T	T	T	T	T	T	T	T	T	T	T	T	T	T
T	T	T	T	T	T	T	T	T	T	T	T	T	T
T	T	T	T	T	T	T	T	T	T	T	T	T	T
T	T	T	T	T	T	T	T	T	T	T	T	T	T
T	T	T	T	T	T	T	T	T	T	T	T	T	T
T	T	T	T	T	T	T	T	T	T	T	T	T	T
T	T	T	T	T	T	T	T	T	T	T	T	T	T
T	T	T	T	T	T	T	T	T	T	T	T	T	T
T	T	T	T	T	T	T	T	T	T	T	T	T	T
T	T	T	T	T	T	T	T	T	T	T	T	T	T
T	T	T	T	T	T	T	T	T	T	T	T	T	T
T	T	T	T	T	T	T	T	T	T	T	T	T	T
T	T	T	T	T	T	T	T	T	T	T	T	T	T
T	T	T	T	T	T	T	T	T	T	T	T	T	T
T	T	T	T	T	T	T	T	T	T	T	T	T	T
T	T	T	T	T	T	T	T	T	T	T	T	T	T
T	T	T	T	T	T	T	T	T	T	T	T	T	T
T	T	T	T	T	T	T	T	T	T	T	T	T	T
T	T	T	T	T	T	T	T	T	T	T	T	T	T
T	T	T	T	T	T	T	T	T	T	T	T	T	T
T	T	T	T	T	T	T	T	T	T	T	T	T	T

 Aguas arriba Aguas abajo In (A) li (kA)		NM8S-125 S/H			NM8S-250 S/H				NM8S-400 S/H/R			
		40	100	125	100	160	200	250	250	315	350	400
	40		1.2	1.2	2	2	T	T	T	T	T	T
	100					2	T	T	T	T	T	T
	125							T	T	T	T	T
NM8-250 S	100							3	5	5	5	5
	160									5	5	
	200											
	250											
NM8-250 H/R	100							3	5	5	5	5
	160									5	5	
	200											
	250											
NM8S-250 S/H	100							5	5	5	5	5
	160							5	5	5	5	5
	200									5	5	
	250										5	
NM8-400 S/H/R	250											
	315											
	350											
	400											
NM8S-400 S/H/R	250											
	315											
	350											
	400											
NM8-630 S/H/R	250											
	315											
	350											
	400											
	500											
NM8S-630 S/H/R	250											
	315											
	350											
	400											
	500											
NM8-800 S/H	630											
	700											
	800											
NM8S-800 S/H	630											
	700											
	800											
NM8-1250 S/H	630											
	700											
	800											
	1000											
	1250											
NM8S-1250 S/H	630											
	700											
	800											
	1000											
	1250											

Nota:

- a. Las áreas que contienen la letra "T" indican protección total por discriminación entre los interruptores de aguas arriba y los de aguas abajo
- b. Las áreas que contienen números indican protección parcial por discriminación entre los interruptores de aguas arriba y los de aguas abajo
- c. Para protección parcial por discriminación, los valores de corrientes de defecto máximos para garantizar la discriminación en tiempo quedan reflejados en la tabla. Cuando la corriente del defecto exceda de este valor los interruptores aguas arriba y aguas abajo pueden disparar al mismo tiempo.

NM8S-630 S/H/R						NM8S-800 S/H			NM8S-1250 S/H				
250	315	350	400	500	630	630	700	800	630	700	800	1000	1250
T	T	T	T	T	T	T	T	T	T	T	T	T	T
T	T	T	T	T	T	T	T	T	T	T	T	T	T
T	T	T	T	T	T	T	T	T	T	T	T	T	T
T	T	T	T	T	T	T	T	T	T	T	T	T	T
			T	T	T	T	T	T	T	T	T	T	T
				T	T	T	T	T	T	T	T	T	T
					T	T	T	T	T	T	T	T	T
T	T	T	T	T	T	40	40	40	40	40	40	T	T
			T	T	T	40	40	40	40	40	40	T	T
				T	T	40	40	40	40	40	40	T	T
					T	40	40	40	40	40	40	T	T
T	T	T	T	T	T	T	T	T	T	T	T	T	T
T	T	T	T	T	T	T	T	T	T	T	T	T	T
			T	T	T	T	T	T	T	T	T	T	T
				T	T	T	T	T	T	T	T	T	T
			8	8	8	30	30	30	30	30	30	T	T
				8	8	30	30	30	30	30	30	T	T
					8	30	30	30	30	30	30	T	T
					8	30	30	30	30	30	30	T	T
			8	8	8	12	12	12	12	12	12	15	15
				8	8	12	12	12	12	12	12	15	15
					8	12	12	12	12	12	12	15	15
					8	12	12	12	12	12	12	15	15
				8	8	30	30	30	30	30	30	T	T
				8	8	30	30	30	30	30	30	T	T
					8	30	30	30	30	30	30	T	T
					8	30	30	30	30	30	30	T	T
							30	30		30	30	T	T
				8	8	12	12	12	12	12	12	15	15
				8	8	12	12	12	12	12	12	15	15
					8	12	12	12	12	12	12	15	15
					8	12	12	12	12	12	12	15	15
							12	12	12	12	12	15	15
								12			12	15	15
												20	20
												15	15
												20	20
												15	15

10.7 Tablas de selección para protección de motores
400V, 50kA, Arranque directo - Motores de arranque normal

Datos del motor		Interruptores automáticos		Contactores		Relés térmicos	
Potencia nominal (kW)	Corriente nominal (A)	Modelo	Ajuste relé magnético (A)	Modelo	Corriente nominal AC1 (A)	Modelo	Corriente nominal (A)
5.5	10.9	NM8-125S/16M	192	NC1-12	20	NR2-25	9~13
7.5	14.4	NM8-125S/20M	240	NC1-18	32	NR2-25	12~18
11	20.9	NM8-125S/25M	300	NC1-25	40	NR2-25	17~25
15	28	NM8-125S/32M	384	NC1-32	50	NR2-36	23~32
18.5	34.1	NM8-125S/40M	480	NC1-40	60	NR2-36	28~36
22	39.4	NM8-125S/50M	600	NC1-50	80	NR2-93	30~40
30	53.4	NM8-125S/63M	756	NC1-65	80	NR2-93	48~65
37	67.9	NM8-125S/80M	960	NC1-80	110	NR2-93	55~70
45	80.5	NM8-125S/100M	1200	NC1-95	110	NR2-93	80~93
55	98.5	NM8-125S/125M	1500	NC2-115	200	NR2-200	80~125
75	133	NM8-250S/160M	1920	NC2-150	200	NR2-200	100~160
90	158.7	NM8-250S/200M	2400	NC2-185	275	NR2-200	100~160
110	192	NM8-250S/250M	3000	NC2-225	275	NR2-200	125~200
132	229	NM8-400S/315M	3780	NC2-265	315	NR2-630	160~250
160	275	NM8-400S/350M	4200	NC2-330	380	NR2-630	200~315
200	343	NM8-400S/400M	4800	NC2-400	450	NR2-630	250~400
250	445	NM8-630S/500M	6000	NC2-500	630	NR2-630	315~500
290	520	NM8S-630S/630M	7560	NC2-630	800	NR2-630	400~630
315	560	NM8S-630S/630M	7560	NC2-630	800	NR2-630	400~630

Nota:

- 1.Los interruptores NM8 y NM8S poseen protección magnética en todos los polos
- 2.Los interruptores NM8S-125, 250, 630 poseen idénticos parámetros que los tipos NM8 de la tabla superior;
- 3.Los relés electrónicos NRE8 pueden reemplazar a los relés térmicos NR2 de la tabla superior, con idénticas características

400V, 50kA, Arranque directo - Motores de arranque pesado

Datos del motor		Interruptores automáticos		Contactores		Relés térmicos	
Potencia nominal (kW)	Corriente nominal (A)	Modelo	Ajuste relé magnético (A)	Modelo	Corriente nominal AC1 (A)	Modelo	Corriente nominal (A)
5.5	10.9	NM8-125S/16M	192	NC1-18	32	NR2-25	9~13
7.5	14.4	NM8-125S/20M	240	NC1-25	40	NR2-25	12~18
11	20.9	NM8-125S/25M	300	NC1-32	50	NR2-25	17~25
15	28	NM8-125S/32M	384	NC1-40	60	NR2-36	23~32
18.5	34.1	NM8-125S/40M	480	NC1-50	80	NR2-36	28~36
22	39.4	NM8-125S/50M	600	NC1-65	80	NR2-93	30~40
30	53.4	NM8-125S/63M	756	NC1-80	110	NR2-93	48~65
37	67.9	NM8-125S/80M	960	NC1-95	110	NR2-93	55~70
45	80.5	NM8-125S/100M	1200	NC2-115	200	NR2-93	80~93
55	98.5	NM8-125S/125M	1500	NC2-150	200	NR2-200	80~125
75	133	NM8-250S/160M	1920	NC2-185	275	NR2-200	100~160
90	158.7	NM8-250S/200M	2400	NC2-225	275	NR2-200	100~160
110	192	NM8-250S/250M	3000	NC2-265	315	NR2-200	125~200
132	229	NM8-400S/315M	3780	NC2-330	380	NR2-630	160~250
160	275	NM8-400S/350M	4200	NC2-400	450	NR2-630	200~315
200	343	NM8-400S/400M	4800	NC2-500	630	NR2-630	250~400
250	445	NM8-630S/500M	6000	NC2-630	800	NR2-630	315~500
290	520	NM8S-630S/630M	7560	NC2-630	800	NR2-630	400~630

Nota:

- 1.Los interruptores NM8 y NM8S poseen protección magnética en todos los polos
- 2.Los interruptores NM8S-125, 250, 630 poseen idénticos parámetros que los tipos NM8 de la tabla superior;
- 3.Los relés electrónicos NRE8 pueden reemplazar a los relés térmicos NR2 de la tabla superior, con idénticas características

400V, 50kA, Motores de arranque estrella-triángulo

Datos del motor		Interruptores automáticos		Contactores			Relés térmicos	
Potencia nominal (kW)	Corriente nominal (A)	Modelo	Ajuste relé magnético (A)	Contactador de línea	Contactador triángulo	Contactador estrella	Modelo	Corriente nominal (A)
5.5	10.9	NM8-125S/16M	192	NC1-09	NC1-09	NC1-09	NR2-11.5	5.5~8
7.5	14.4	NM8-125S/20M	240	NC1-12	NC1-12	NC1-09	NR2-11.5	7~10
11	20.9	NM8-125S/25M	300	NC1-18	NC1-18	NC1-09	NR2-25	9~13
15	28	NM8-125S/32M	384	NC1-25	NC1-25	NC1-12	NR2-25	12~18
18.5	34.1	NM8-125S/40M	480	NC1-25	NC1-25	NC1-18	NR2-25	17~25
22	39.4	NM8-125S/50M	600	NC1-32	NC1-32	NC1-18	NR2-36	23~32
30	53.4	NM8-125S/63M	756	NC1-40	NC1-40	NC1-25	NR2-36	28~36
37	67.9	NM8-125S/80M	960	NC1-50	NC1-50	NC1-32	NR2-93	30~40
45	80.5	NM8-125S/100M	1200	NC1-65	NC1-65	NC1-32	NR2-93	37~50
55	98.5	NM8-125S/125M	1500	NC1-80	NC1-80	NC1-40	NR2-93	48~65
75	133	NM8-250S/160M	1920	NC1-95	NC1-95	NC1-50	NR2-93	63~80
90	158.7	NM8-250S/200M	2400	NC2-115	NC2-115	NC2-65	NR2-93	80~93
110	192	NM8-250S/250M	3000	NC2-150	NC2-150	NC2-80	NR2-200	80~125
132	229	NM8-400S/315M	3780	NC2-150	NC2-150	NC2-95	NR2-200	80~125
160	275	NM8-400S/350M	4200	NC2-185	NC2-185	NC2-115	NR2-200	100~160
200	343	NM8-400S/400M	4800	NC2-225	NC2-225	NC2-150	NR2-200	125~200
250	445	NM8-630S/500M	6000	NC2-330	NC2-330	NC2-185	NR2-630	200~315
290	520	NM8S-630S/630M	7560	NC2-400	NC2-400	NC2-185	NR2-630	200~315
315	560	NM8S-630S/630M	7560	NC2-400	NC2-400	NC2-225	NR2-630	250~400

Nota:

1. Los interruptores NM8 y NM8S poseen protección magnética en todos los polos
2. Los interruptores NM8S-125, 250, 630 poseen idénticos parámetros que los tipos NM8 de la tabla superior;
3. Los relés electrónicos NRE8 pueden reemplazar a los relés térmicos NR2 de la tabla superior, con idénticas características
4. El interruptor se halla situado en el lado de la alimentación
5. En el circuito de la conexión triángulo, donde se halla situado el relé térmico, la corriente de ajuste es 0.58Ie
6. El tiempo de arranque máximo es de 20 segundos
7. Cuando se produce el cambio de la conexión Estrella a Triángulo, se recomiendan las siguientes conexiones de motor:
 L1, U1 a V2; V1 a W2; L3, W1 a U2 para reducir la corriente de arranque
8. El intervalo de tiempo para el cambio de estrella a triángulo es de 0,1 segundo

NM1 Interruptores en Caja Moldeada

General	Página 59
Composición referencia	Página 59
Clasificación	Página 59
Condiciones de trabajo	Página 60
Características técnicas	Página 61
Relé magnetotérmico	Página 64
Despiece	Página 65
Curvas de disparo	Página 67
Coefficiente de corrección compensación de temperatura	Página 70
Terminales	Página 70
Dimensiones generales y de montaje	Página 73
Accesorios	Página 76
Información técnica adicional	Página 81
Tabla de pares de apriete	Página 82
Poder de corte a distintas tensiones	Página 82
Protección en cascada	Página 84



NM1 Interruptores en Caja Moldeada

1. General

- 1.1 Certificados: KEMA, RCC, GOST, ESC, UKRSEPRO, EK;
- 1.2 Tensión nominal: 690Vca, 50/60HZ,
- 1.3 Corrientes nominales: 10~1250A;
- 1.4 Modo de montaje: Vertical y horizontal;
- 1.5 Estándar: UNE-EN60947-2.

	Holanda	
	Rep. Checa	
	Ucrania	
	Rusia	
	Sudáfrica	
	Corea	

2. Composición referencia

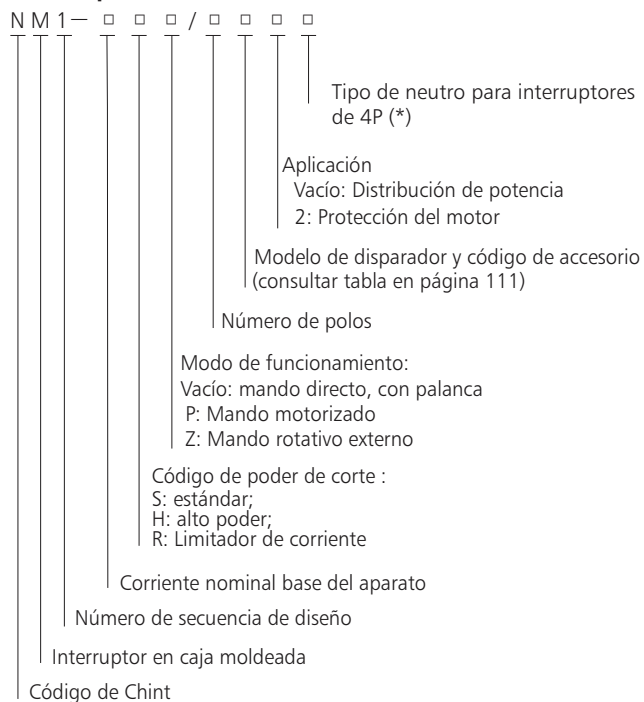

Nota *: Hay 4 tipos de Neutro para los interruptores de 4P A: Sin bloque de relés de protección - el neutro está siempre conectado, no se conecta y desconecta con los otros tres polos; B: Sin bloque de relés de protección - el neutro se conecta con los otros tres polos (desconecta antes y conecta después de las fases); C: Con bloque de relés de protección - el neutro se conecta con los otros tres polos (desconecta antes y conecta después de las fases); D: Con bloque de relés de protección - el neutro está siempre conectado, no se conecta y desconecta con los otros tres polos.

3. Clasificación

Según el poder de corte del interruptor:

Estándar (S)

Alto poder de corte (H)

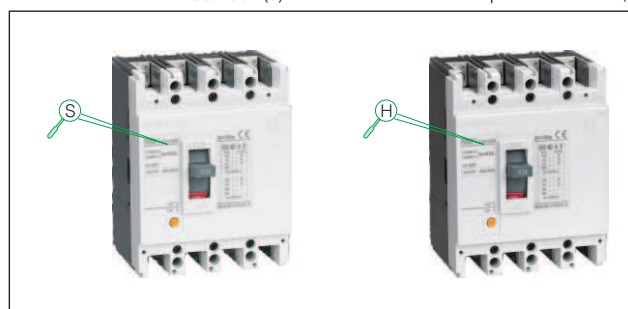

Llimitador de corriente (R)

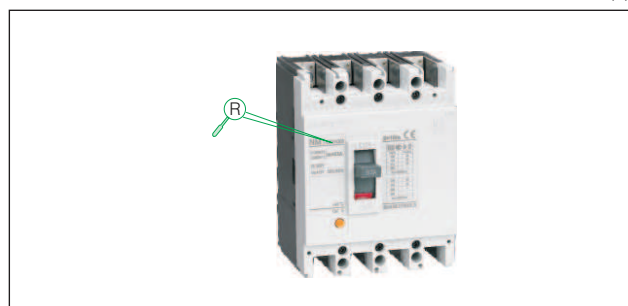

Según el sistema de conexión:

Conexión frontal



Conexión posterior



Conexión enchufable



Según el modo de accionamiento

Accionamiento directo con palanca



Accionamiento con mando rotativo



Accionamiento motorizado



Según el número de polos:

2P



3P



4P



4. Condiciones de trabajo

4.1 Temperatura: $-5^{\circ}\text{C}\sim+40^{\circ}\text{C}$; el valor medio en 24h no debe superar los $+35^{\circ}\text{C}$ (consulte los coeficientes en P70 para la compensación por temperatura ambiente). Para interruptores magnetotérmicos la temperatura de calibración es $+40^{\circ}\text{C}$. Para temperaturas entre $-5^{\circ}\text{C}\sim+40^{\circ}\text{C}$, contactar con Chint para consultar la corrección idónea.

4.2 Altitud: no superior a 2000m (contacte con Chint para consultar el coeficiente si la altitud del lugar de instalación supera los 2000m)

4.3 Grado de contaminación: Grado 3.

4.4 Condiciones ambientales

En el lugar de la instalación, la humedad relativa no debe superar el 50% a una temperatura máxima de $+40^{\circ}\text{C}$, sin embargo una humedad relativa superior es permisible bajo temperaturas inferiores. Por ejemplo, puede ser del 90% a $+20^{\circ}\text{C}$, debiéndose de tomar medidas especiales en caso de condensación.

8. Curvas de disparo (calibradas a 40°C)

8.1 Curvas

Curva característica para NM1-63(10~32), NM1-125(16~32)

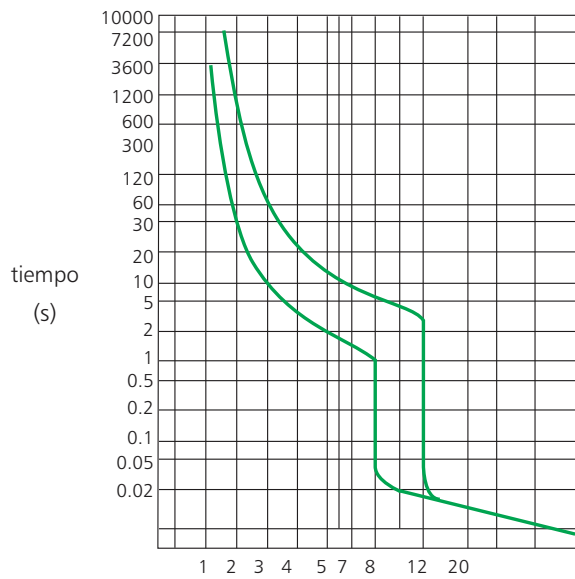

Múltiplos de la corriente nominal

Curva de compensación de temperatura para NM1-63(10~32), NM1-125(16~32)

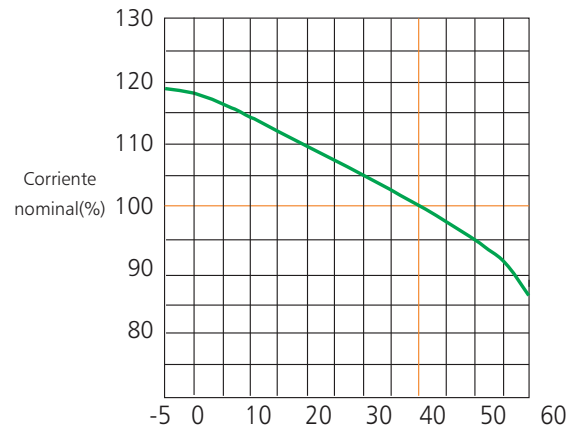

Temperatura ambiente (°C)

Curva característica para NM1-63(40~63), NM1-125(40~125)

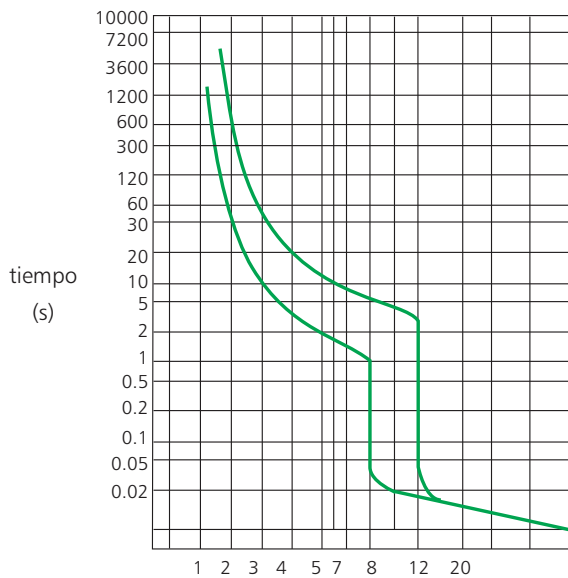

Múltiplos de la corriente nominal

Curva de compensación de temperatura para NM1-63(40~63), NM1-125(40~125)

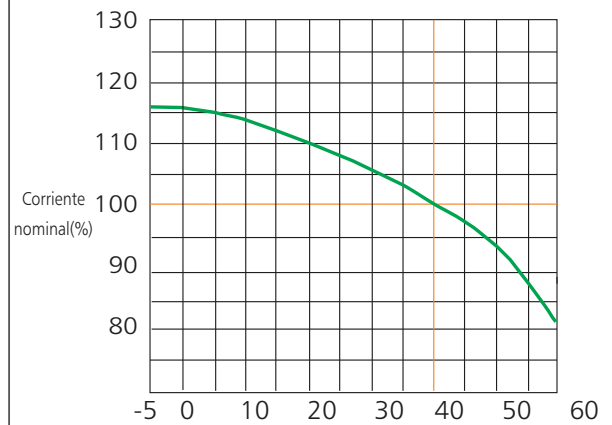

Temperatura ambiente (°C)

5. Características técnicas

Características técnicas según UNE-EN60947-2		63				125				250				400				630				800				1250															
Características eléctricas		10, 16, 20, 25, 30, 32, 40, 50, 60, 63				16, 20, 25, 30, 32, 40, 50, 60, 63, 75, 80, 100, 125				100, 125, 140, 150, 160, 175, 180, 200, 225, 250				225, 250, 300, 315, 350, 400				400, 500, 630				630, 700, 800				700, 800, 900, 1000, 1250															
Corriente nominal (A) In		500				800				800				800				800				800				800															
Tensión nominal de aislamiento U _i (V)		6				8				8				8				8				8				8															
Impulso de tensión máxima al choque (V) U _{imp}		415				690				690				690				690				690				690															
Tensión nominal de servicio (V) U _e AC 50/60Hz		≤50				≤50				≤50				≤100				≤100				≤100				≤100															
Distancia de formación de arco (mm)		S				C				S				C				S				H				R				H											
Código de poder de corte		S				C				S				C				S				H				R				H											
Poles		2	3	4	5	2	3	4	5	2	3	4	5	2	3	4	5	2	3	4	5	2	3	4	5	2	3	4	5	2	3	4	5	2	3	4	5	2	3	4	5
Poder de corte último en cortocircuito I _{cu} (kA, RMS)		20	20	42	42	25	25	42	42	25	25	42	42	25	25	42	42	25	25	42	42	25	25	42	42	25	25	42	42	25	25	42	42	25	25	42	42	25	25	42	42
Secuencia de prueba O-I-CO		66/69/0Vca	66/69/0Vca	66/69/0Vca	66/69/0Vca	66/69/0Vca	66/69/0Vca	66/69/0Vca	66/69/0Vca	66/69/0Vca	66/69/0Vca	66/69/0Vca	66/69/0Vca	66/69/0Vca	66/69/0Vca	66/69/0Vca	66/69/0Vca	66/69/0Vca	66/69/0Vca	66/69/0Vca	66/69/0Vca	66/69/0Vca	66/69/0Vca	66/69/0Vca	66/69/0Vca	66/69/0Vca	66/69/0Vca	66/69/0Vca	66/69/0Vca	66/69/0Vca	66/69/0Vca	66/69/0Vca	66/69/0Vca								
Poder de corte de servicio en cortocircuito I _{cs} (kA, RMS)		50%	50%	50%	50%	50%	50%	50%	50%	50%	50%	50%	50%	50%	50%	50%	50%	50%	50%	50%	50%	50%	50%	50%	50%	50%	50%	50%	50%	50%	50%	50%									
Adecuado para aislamiento		■	■	■	■	■	■	■	■	■	■	■	■	■	■	■	■	■	■	■	■	■	■	■	■	■	■	■	■	■	■	■									
Categoría de utilización		A	A	A	A	A	A	A	A	A	A	A	A	A	A	A	A	A	A	A	A	A	A	A	A	A	A	A	A	A	A	A									
Conexión frontal		■	■	■	■	■	■	■	■	■	■	■	■	■	■	■	■	■	■	■	■	■	■	■	■	■	■	■	■	■	■	■									
Conexión posterior		■	■	■	■	■	■	■	■	■	■	■	■	■	■	■	■	■	■	■	■	■	■	■	■	■	■	■	■	■	■	■									
Conexión enchufable		■	■	■	■	■	■	■	■	■	■	■	■	■	■	■	■	■	■	■	■	■	■	■	■	■	■	■	■	■	■	■									
Botina de emisión de corriente		■	■	■	■	■	■	■	■	■	■	■	■	■	■	■	■	■	■	■	■	■	■	■	■	■	■	■	■	■	■	■									
Botina de mínima tensión		■	■	■	■	■	■	■	■	■	■	■	■	■	■	■	■	■	■	■	■	■	■	■	■	■	■	■	■	■	■	■									
Contacto auxiliar		■	■	■	■	■	■	■	■	■	■	■	■	■	■	■	■	■	■	■	■	■	■	■	■	■	■	■	■	■	■	■									
Contacto de alarma		■	■	■	■	■	■	■	■	■	■	■	■	■	■	■	■	■	■	■	■	■	■	■	■	■	■	■	■	■	■	■									

Nota: ① Para aparatos de 63H hasta 800H existen versiones con formación de arco cero (excepto 800H4P)
 ② Los símbolos O-I-CO, O-I-CO-I-CO se utilizan para definir la secuencia de operaciones.
 O: corte; t: intervalo de tiempo entre dos cortocircuitos sucesivos; CO: conexión inmediata; r: retorno a situación de corte.

6. Relé magnetotérmico

Apertura en tiempo inverso en caso de disparo del interruptor por sobrecorriente (para distribuciones de potencia) en las situaciones en que todos los polos hayan sido alimentados simultáneamente.

Secuencia	Comprobación de la corriente	I _n	Tiempo convencional	Estado inicial
1	Corriente en disparo convencional	1,05 I _n (n<=63A)	2h(n<=63A)	Estado en frío
2	Corriente en disparo convencional	1,30 I _n (n<=63A)	2h(n<=63A)	Justo después de la sec. n°1

Apertura en retardo de tiempo inverso en caso de disparo del interruptor por sobrecorriente (para protecciones de motor) en las situaciones en que todos los polos hayan sido alimentados simultáneamente (según UNE-EN60947-3).

Secuencia	Ajuste de corriente convencional	Tiempo convencional	Estado inicial	Notas
1	1,0 In	>2h	Estado frío	
2	1,2 In	≤2h	Auto después de pueba n°1	
3	1,5 In	≤4min	Estado frío	10≤In≤225
4	7,2 In	4s≤t≤10s	Estado frío	225≤In≤630
		6s≤t≤20s	Estado frío	10≤In≤225
			Estado frío	225≤In≤630

El neutro del interruptor 4P se encuentra en el lado derecho del mismo. Consultar la corriente nominal del disparador del neutro, en caso de los tipos C y D en la siguiente tabla.

Corriente base del aparato (A)	Corriente nominal (A)	Corriente nominal del neutro (A)
10	10	10
16	16	16
20	20	20
25	25	25
30	30	30
32	32	32
40	40	40
50	50	50
60	60	60
63	63	63
16	16	16
20	20	20
25	25	25
30	30	30
32	32	32
40	40	40
50	50	50
60	60	60
63	63	63
75	75	63
80	80	63
100	100	63
125	125	63

7. Despiece

Interruptor en Caja Moldeada serie NIM1

- 1 Interruptor (tipo fip)
- 2 Interruptor (tipo enchufable)
- 3 Conexión posterior
- 4 Bobina de mínima tensión
- 5 Bobina de emisión de corriente
- 6 Contacto de alarma
- 7 Contacto auxiliar
- 8 Accionamiento motorizado
- 9 Mando manual con eje prolongado
- 10 Bloqueo mecánico
- 11 Terminal para cable (ver Pág.102)
- 12 Culebromes
- 13 Platina para conexión frontal

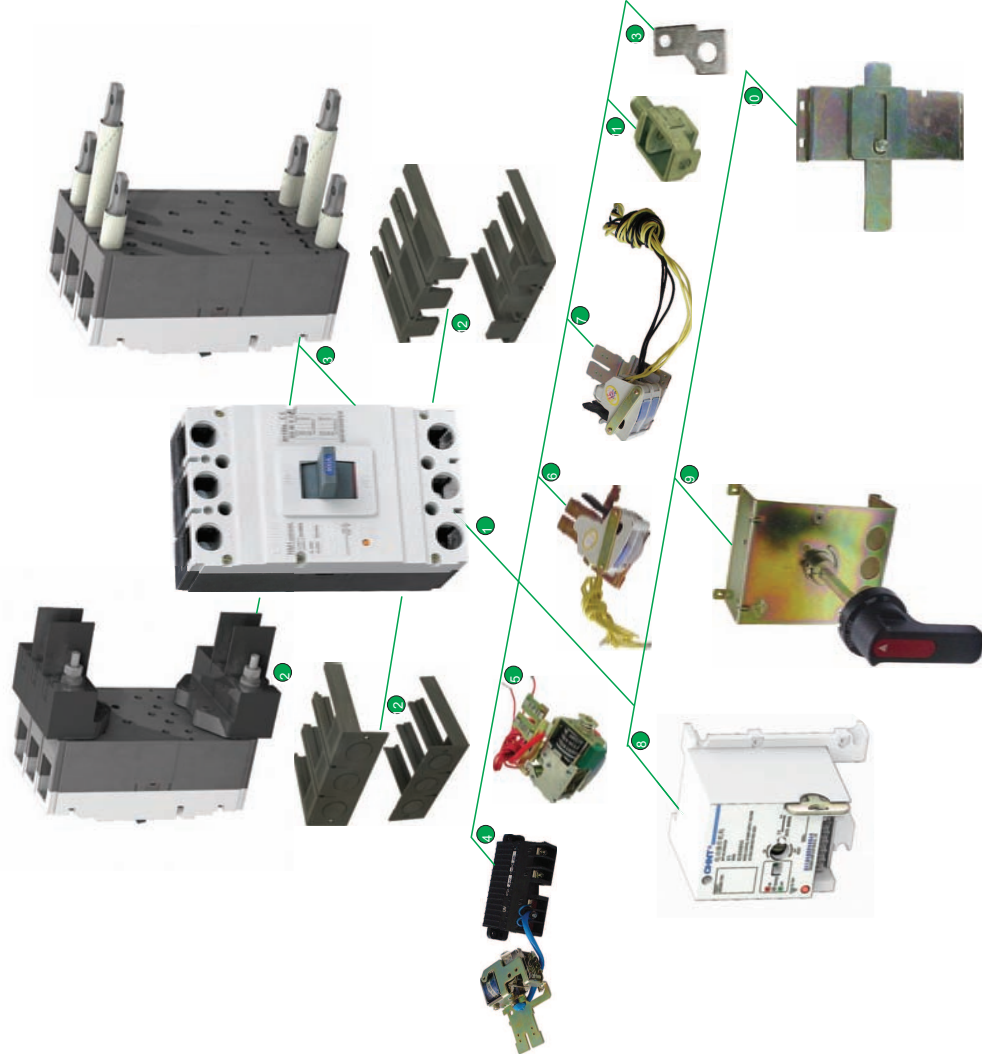

Nota: Bajo demanda pueden suministrarse aparatos con la corriente admisible en el neutro igual que la de las fases.

8. Curvas de disparo (calibradas a 40°C)

8.1 Curvas

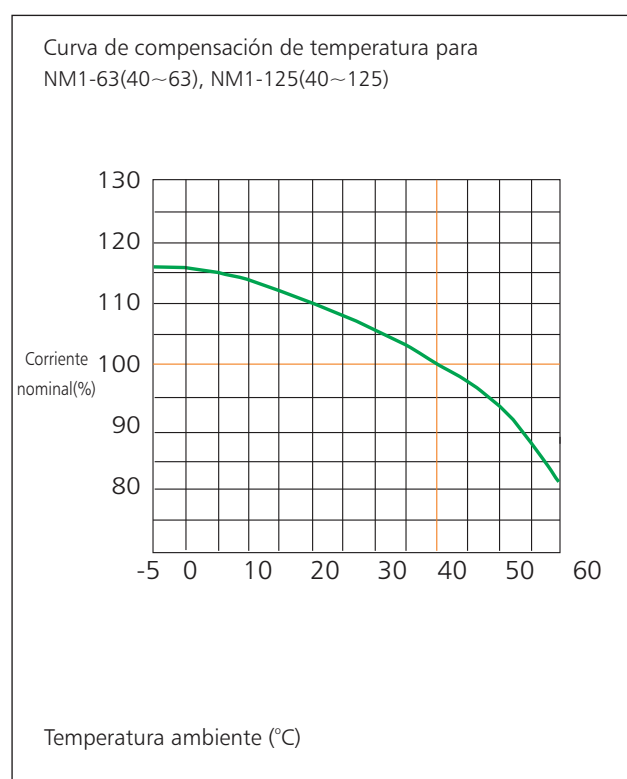
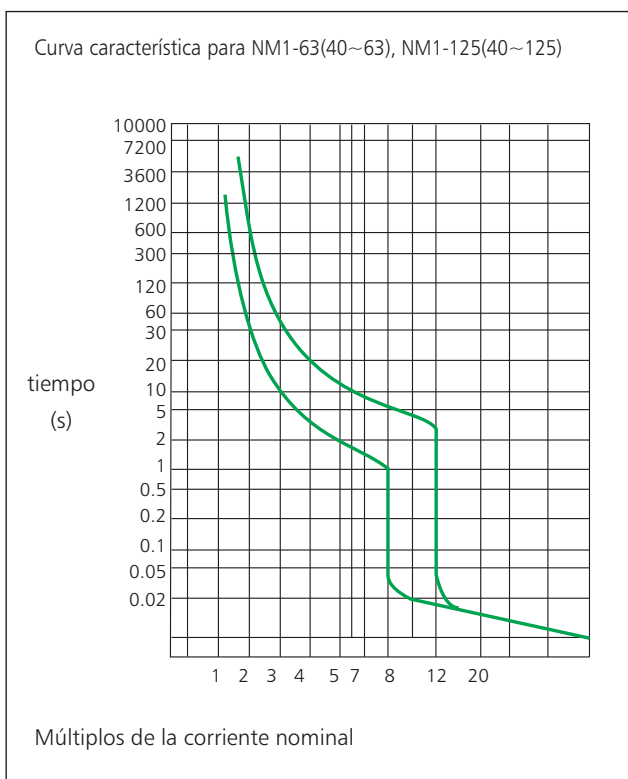
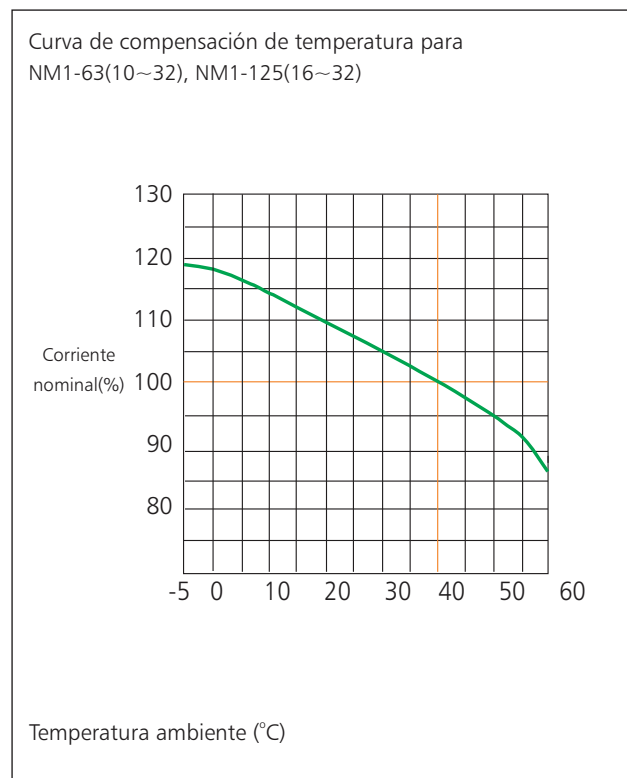
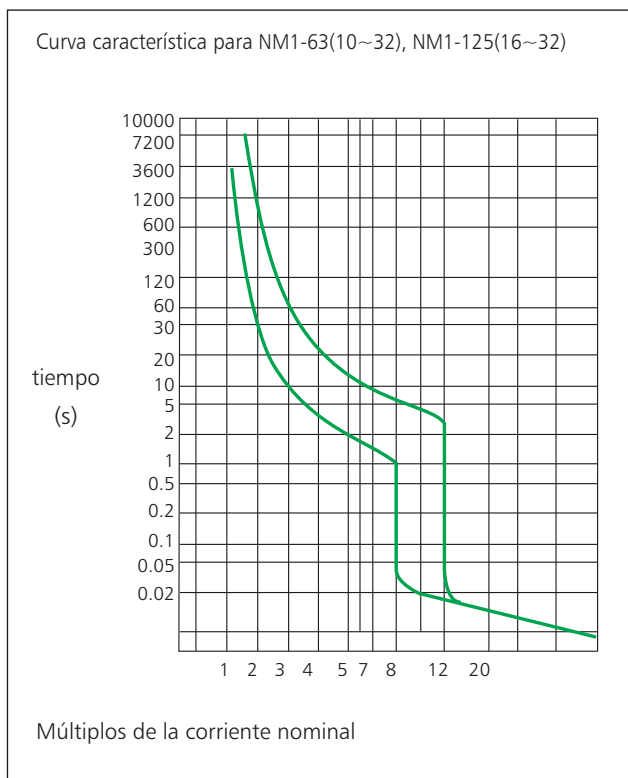

Curva característica para NM1-250

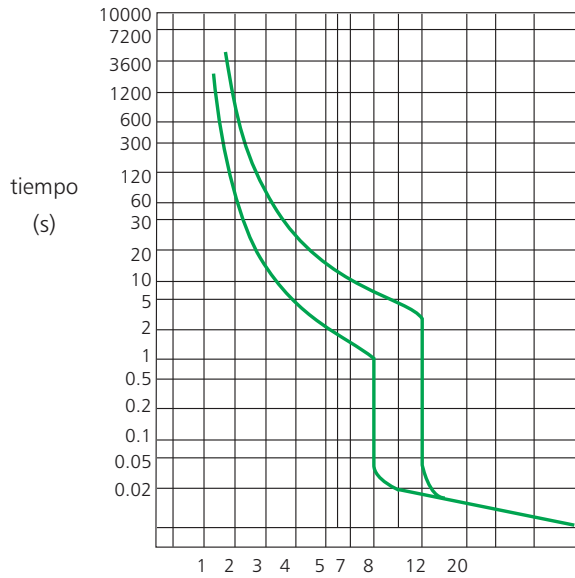

Múltiplos de la corriente nominal

Curva de compensación de temperatura para NM1-250

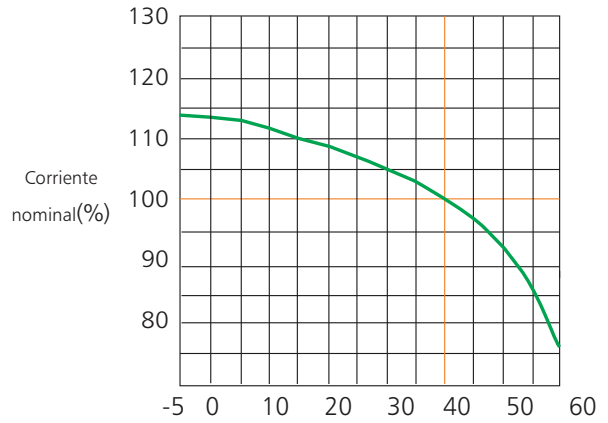

Temperatura ambiente (°C)

Curva característica para NM1-400

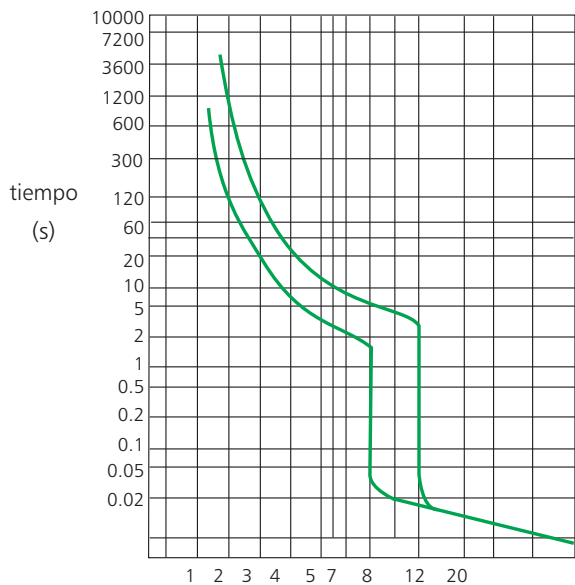

Múltiplos de la corriente nominal

Curva de compensación de temperatura para NM1-400

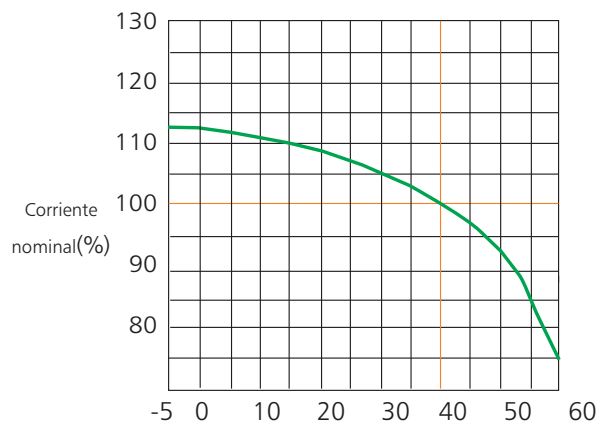

Temperatura ambiente (°C)

Curva característica para NM1-630, 800

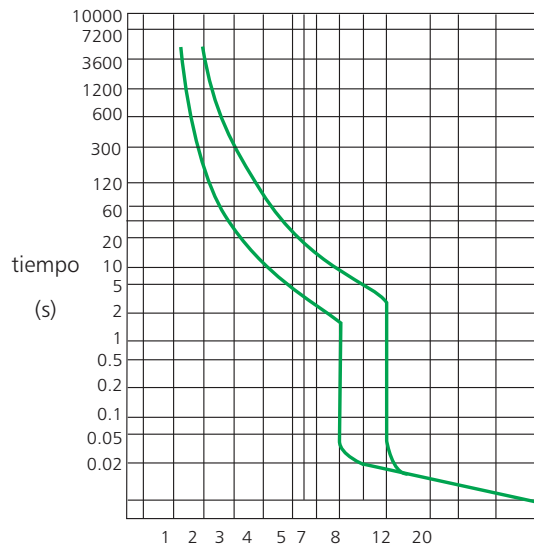

Múltiplos de la corriente nominal

Curva de compensación de temperatura para NM1-630, 800

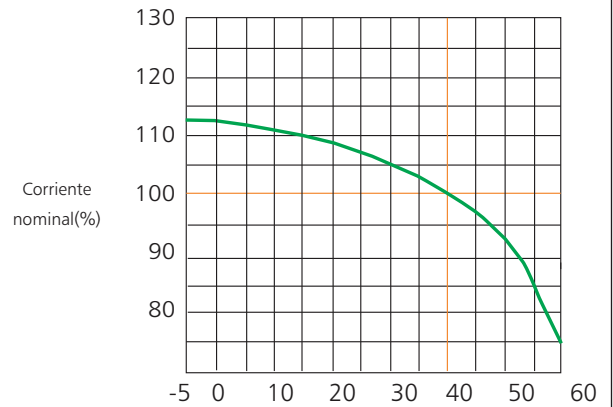

Temperatura ambiente (°C)

Curva característica para NM1-1250

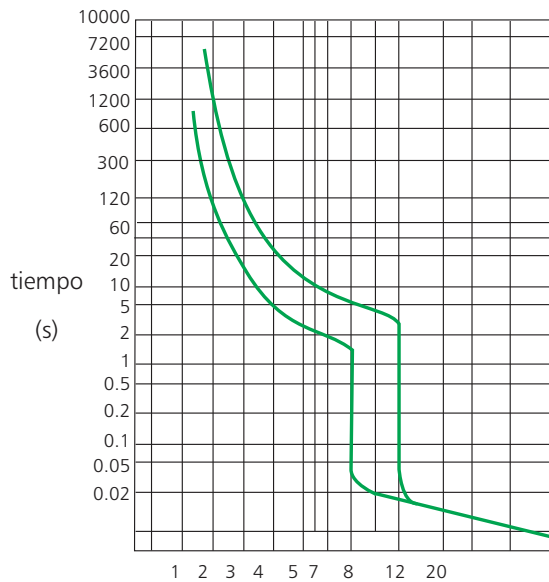

Múltiplos de la corriente nominal

Curva de compensación de temperatura para NM1-1250

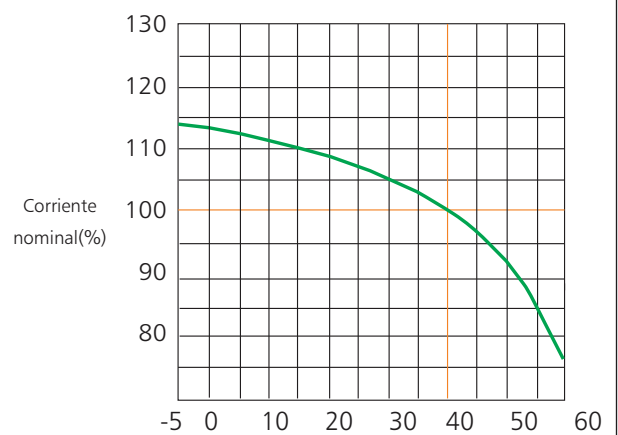

Temperatura ambiente (°C)

8.2 Coeficientes de corrección para compensación de la temperatura

Tabla de coeficientes para interruptores NM1 (calibración estandar: 40°C, para calibración a otras temperaturas contactar con Chint)

Modelo	Rango de corriente	Coeficiente de compensación													
		-5°C	0°C	5°C	10°C	15°C	20°C	25°C	30°C	35°C	40°C	45°C	50°C	55°C	60°C
NM1-63S, H	10~32A	1.18	1.17	1.16	1.14	1.12	1.09	1.07	1.05	1.03	1	0.97	0.95	0.92	0.87
NM1-63S, H	40~63A	1.16	1.16	1.15	1.14	1.12	1.10	1.08	1.06	1.03	1	0.97	0.94	0.87	0.82
NM1-125C, S, H, R	16~32A	1.18	1.17	1.16	1.14	1.12	1.09	1.07	1.05	1.03	1	0.97	0.95	0.92	0.87
NM1-125C, S, H, R	40~100A	1.16	1.16	1.15	1.14	1.12	1.10	1.08	1.06	1.03	1	0.97	0.94	0.87	0.82
NM1-250C, S, H, R	100~225A	1.14	1.13	1.13	1.12	1.10	1.08	1.07	1.05	1.03	1	0.97	0.93	0.86	0.76
NM1-400S, H, R	225~400A	1.13	1.12	1.12	1.11	1.10	1.08	1.06	1.05	1.03	1	0.97	0.93	0.85	0.75
NM1-630S, H, R	400~630A	1.13	1.12	1.12	1.11	1.10	1.08	1.07	1.05	1.03	1	0.97	0.93	0.85	0.75
NM1-800S,H, R	630~800A	1.13	1.12	1.12	1.11	1.10	1.08	1.07	1.05	1.03	1	0.97	0.93	0.85	0.75
NM1-1250H	700~1250A	1.14	1.13	1.12	1.11	1.10	1.09	1.07	1.05	1.03	1	0.97	0.92	0.85	0.76

9. Terminales

Conexión frontal (Conexión fija)

Terminales de conexión (para aparatos de 10 a 1250A existen terminales prolongados)

Tornillos de conexión



Calibre base del aparato	Corriente (A)	Código de poder de corte	Conexión frontal		
			Tornillo hexagonal (B)	Tornillo hexagonal (A)	Tornillo de cruz (C)
63	10	S	■		
		H	■		
	16	S	■		
		H	■		
	20	S	■		
		H	■		
	25	S	■		
		H	■		
	30	S	■		
		H	■		
	32	S	■		
		H	■		
	40	S	■		
		H	■		
	50	S	■		
		H	■		
	63	S	■		
		H	■		
125	16	C			■
		S			■
		H			■
	20	R			■
		C			■
		S			■
	25	H			■
		R			■
		C			■
	30	S			■
		H			■
		R			■
	32	C			■
		S			■
		H			■
	40	R			■
		C			■
		S			■
50	H			■	
	R			■	
	C			■	
60	S			■	
	H			■	
	R			■	
63	C			■	
	S			■	
	H			■	
75	R			■	
	C			■	
	S			■	

Calibre base del aparato	Corriente (A)	Código de poder de corte	Conexión frontal		
			Tornillo hexagonal (B)	Tornillo hexagonal (A)	Tornillo de cruz (C)
80	80	C			■
		S			■
		H			■
	100	R			■
		C			■
		S			■
125	100	H			■
		R			■
		C			■
	125	S			■
		H			■
		R			■
250	100	C	■		
		S	■		
		H	■		
	125	R	■		
		C	■		
		S	■		
	140	H	■		
		R	■		
		C	■		
	150	S	■		
		H	■		
		R	■		
160	C	■			
	S	■			
	H	■			
175	R	■			
	C	■			
	S	■			
180	H	■			
	R	■			
	C	■			
200	S	■			
	H	■			
	R	■			
250	C	■			
	S	■			
	H	■			
225	R	■			
	S		■		
	H		■		
250	R		■		
	S		■		
	H		■		
300	R		■		
	S		■		
	H		■		

Calibre base del aparato	Corriente (A)	Código de poder de corte	Conexión frontal		
			Tornillo hexagonal (B)	Tornillo hexagonal (A)	Tornillo de cruz (C)
315		S		■	
		H		■	
		R		■	
400	350	S		■	
		H		■	
		R		■	
400	400	S		■	
		H		■	
		R		■	
400	400	S		■	
		H		■	
		R		■	
630	500	S		■	
		H		■	
		R		■	
630	630	S		■	
		H		■	
		R		■	
800	630	H	■		
		R	■		
800	700	H	■		
		R	■		
800	800	H	■		
		R	■		
1250	700	H	■		
1250	800	H	■		
1250	900	H	■		
1250	1000	H	■		
1250	1250	H	■		

Terminales de conexión

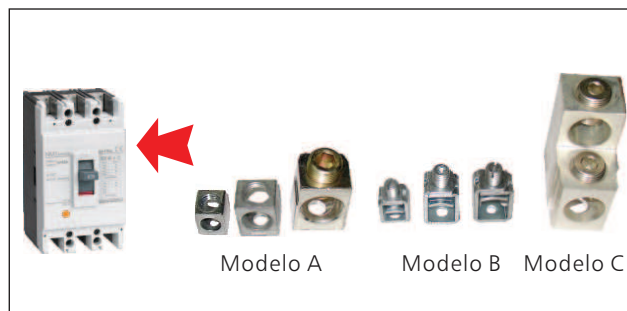

Conexión posterior

Conexión trasera disponible para interruptores de 3P y 4P
- NM1-63 a NM1-800



Conexión enchufable

Conexión enchufable disponible para interruptores de 3P y 4P
- NM1-63 a NM1-800

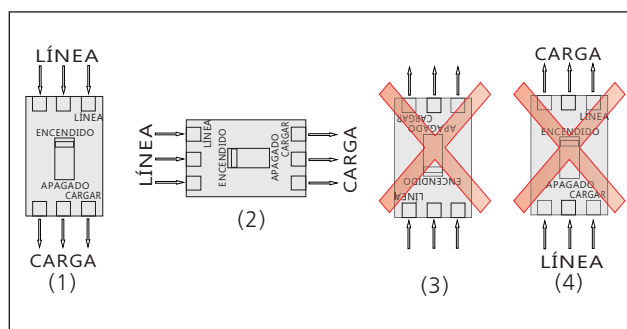

Los interruptores NM1 pueden ser conectados según se muestra en los dibujos (1) y (2). Puesto que el poder de corte del aparato puede verse afectado, el modo de conexión (3) no es recomendable sin el consentimiento y autorización de Chint. El modo de conexión (4) no está permitido para esta serie de interruptores.

10. Dimensiones generales y de montaje

Dimensiones generales y de montaje de NM1-63,100,225 (Tipos fijos)

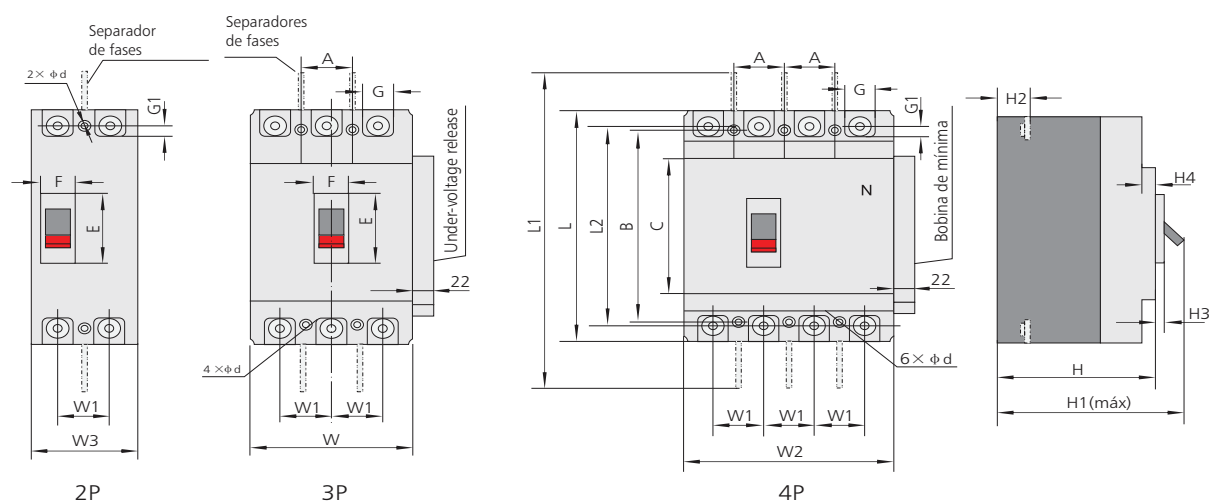

(mm)

Dimension	NM1-63S	NM1-63H	NM1-125C NM1-125S	NM1-125H NM1-125R	NM1-250C NM1-250S	NM1-250H NM1-250R
Dimensiones generales	C	85	85	84	102	102
	E	48	48	50.5	50.5	51
	F	22	22	22	22	22
	G	14	14	17.5	17.5	23
	G1	6.5	6.5	7.5	7.5	11.5
	H	72	82	67	87	86
	H1	90	100	84	103	110
	H2	18	28	24	24	24
	H3	4	4	4	4	4
	H4	6	6	7	7	5
	L	135	135	155	155	165
	L1	233	235	255	255	360
	L2	117	117	136	136	144
	W	76	76	90	90	105
	W1	25	25	30	30	35
	W2	-	102.5	-	120	-
W3	-	-	-	65	-	
Dimensiones del montaje	A	25	25	30	35	35
	B	117	117	130.5	130.5	126
	ϕd	4.5	4.5	4.5×6	4.5×6	5.5

Dimensiones generales y de montaje de NM1-400, 630, 800, 1250(Modelo fijo)

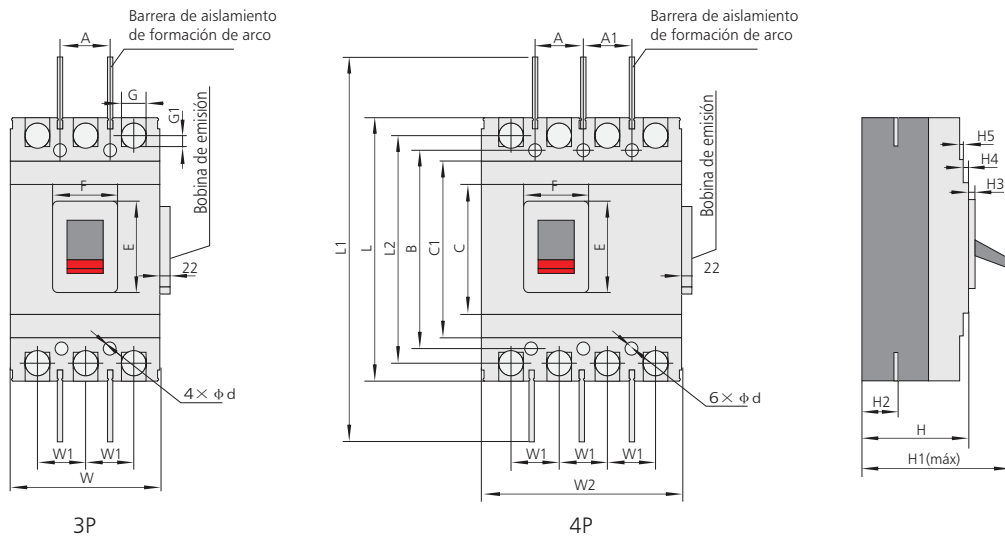

(mm)

Dimensiones	NM1-400S NM1-400H NM1-400R	NM1-630S NM1-630H NM1-630R	NM1-800H/R	NM1-1250H	
Dimensiones generales	C	127.5	134.5	136	265.5
	C1	173.5	184.5	204	345.5
	E	88.5	89	81	97
	F	65	65.5	66	78
	G	30.5	44	45	-
	G1	11	13.5	12.5	-
	H	107	112	116	141
	H1	162	164.5	168	202
	H2	40	42	41.5	58
	H3	6.5	7	4.5	16.5
	H4	5	3.5	5	2
	H5	5	4.5	8	4.5
	L	257	270.5	280	406*
	L1	457	470	485	715
	L2	224	234	243	-
	W	150	182	210	210
W1	48	58	70	70	
W2	197.5	240	280	-	
Dimensiones del montaje	A	44	58	70	70
	B	194	200	243	375
	φ d	7	7	7	10

Dimensiones generales y de montaje de
 NM1-63, 100, 225(Modelo fijo)

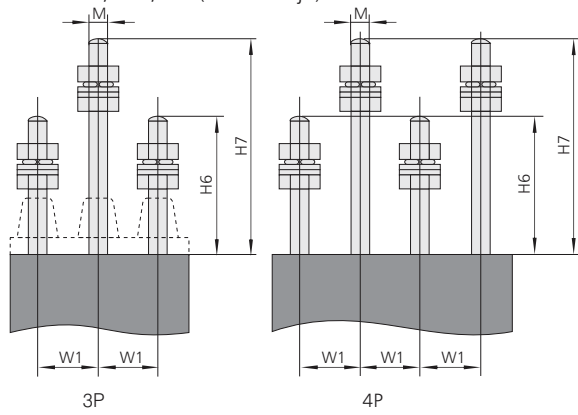

Dimensiones generales y de montaje de
 NM1-400, 630, 800(Modelo fijo)



Gráfico de perforación de la placa trasera



Modelo enchufable

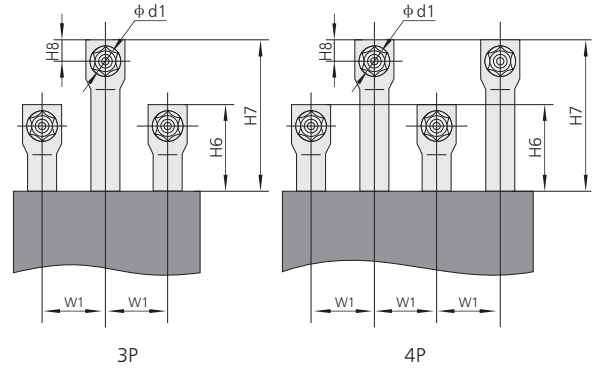
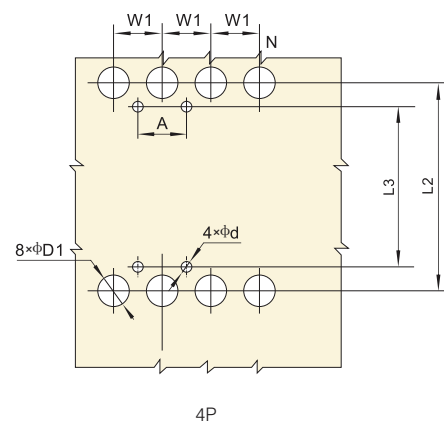
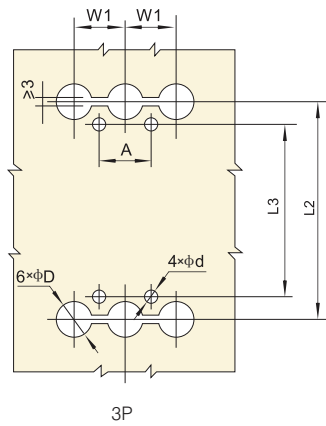

Gráfico de montaje 3P



Gráfico de perforación 3P de la placa de montaje

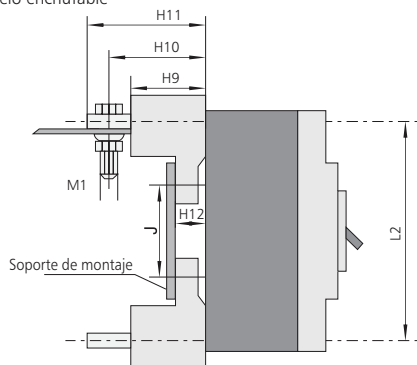

Gráfico de perforación 4P de la placa de montaje

(mm)

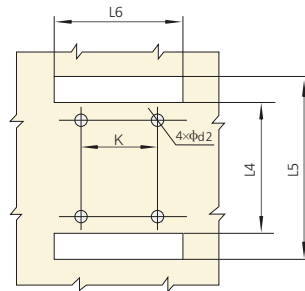
Dimensiones		NM1-63S NM1-63H	NM1-125S NM1-125H NM1-125R	NM1-250S NM1-250H NM1-250R	NM1-400S NM1-400H NM1-400R	NM1-630S NM1-630H NM1-630R	NM1-800H NM1-800R
Dimensiones de conexión trasera y modelo enchufable	A	25	30	35	44	58	70
	φ d	4.5	4.5×6	5.5	7	7	7
	φ d1	-	-	-	φ 12	φ 16	φ 16
	φ d2	6	8	8	9	9	12
	φ D	8	10	12	33	37	37
	φ D1	8	10	12	33	37	37
	H6	S:32 / H:23	63.5	67.5	39	45	64
	H7	S:47 / H:38	96.5	118.5	74	79	64
	H8	-	-	-	18	20	20
	H9	28	50	50	60	60	87
	H10	38	67.5	71.5	88	92	143.5
	H11	44.5	81	84.5	111	110	158.7
	H12	10	18	18	21.5	21	27
	L2	117	136	144	224	234	243
	L3	117	130.5	126	194	200	243
	L4	97	93	93	163	165	173
	L5	138	180	190	285	302	305
	L6	80/105*	95/125*	110/140*	150/198*	180/238*	215/285*
	M	M6	M8	M10	-	-	-
	K	50	60	70	60	100	90
K1	25	30	35	66	66	95	
J	60	58	54	130.4	124	146	
M1	M5	M8	M8	M10	M12	M12	
W1	25	30	35	48	58	70	
W2	12.5	15	17.5	24	29	35	

Nota: El "*" representa la dimensión de los interruptores de 3P/4P

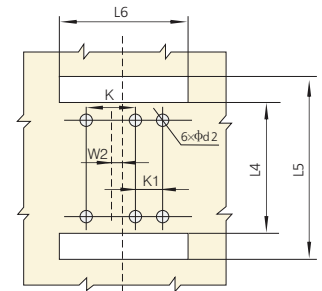
11. Accesorios

Accesorios internos

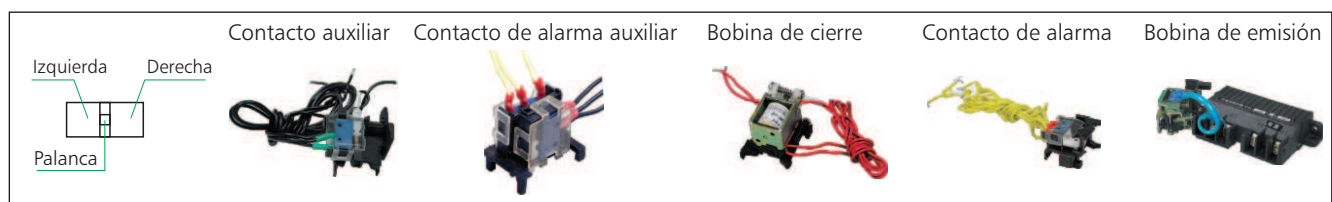

Accesorios	Código de accesorio		Modo de montaje y conexiones				
	Disparador sólo magnético	Disparador compuesto	NM1-63S NM1-125C,S,H,R NM1-250C,S,H,R	NM1-63S,H NM1-125C,S,H,R NM1-250C,S,H,R NM1-400S,H,R	NM1-630S,H,R	NM1-800H, R	NM1-1250H
			2P	3P 4P	3P 4P	3P 4P	3P
Sin accesorios	200	300					
Contacto de alarma	208	308					
Bobina de cierre	210	310					
Contacto auxiliar	220	320					
Bobina de emisión	230	330					
Bobina de cierre, contacto auxiliar	240	340					
Bobina de cierre, bobina de emisión	250	350					
Dos grupos de contactos auxiliares	260	360					
Contacto auxiliar, bobina de emisión	270	370					
Bobina de cierre, contacto de alarma	218	318					
Contacto de alarma auxiliar	228	328					
Bobina de emisión, contacto de alarma	238	338					
Bobina de cierre, contacto auxiliar	248	348					
Dos grupos de contacto auxiliar del contacto de alarma auxiliar	268	368					
Bobina de emisión, contacto de alarma auxiliar	278	378					

11.1 Bobina de mínima

- a. $U_n=70\sim 35\% U_s$, la bobina puede actuar
- b. $U_n < 35\% U_s$, impide la conexión del interruptor
- c. $U_n > 85\% U_s$, conexión segura

Tensión nominal de la bobina de mínima: 50Hz, 230Vca y 400Vca

Códigos de la bobina de mínima

Código	A2	A4	D1	D2
Tensión	230Vca	400Vca	110Vcc	220Vcc
Frecuencia nominal	50Hz	50Hz	-	-

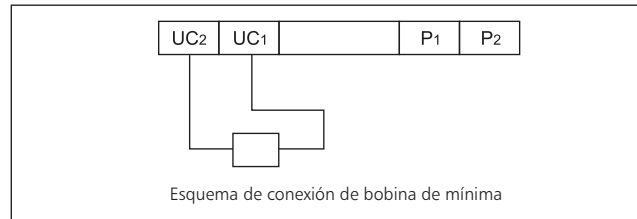

11.2 Bobina de emisión

La tensión de control nominal de la bobina de emisión es 50Hz, 230V y 400V.

$U_n=70\% \sim 110\% U_s$, conexión segura

Código de bobina de emisión

Código	A1	A2	A4	D1	D2	D3
Tensión	110/127Vca	230Vca	400Vca	110Vcc	220Vcc	24Vcc
Frecuencia nominal	50Hz	50Hz/ 60Hz	50Hz/ 60Hz	-	-	-

Nota: Con una tensión de 24Vcc, la corriente nominal es de $5A \pm 10\%$

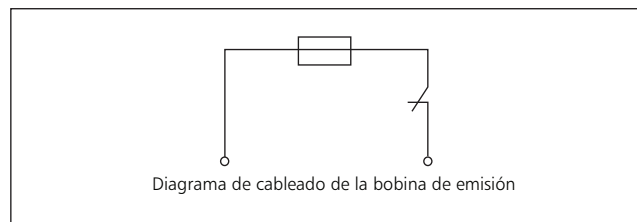
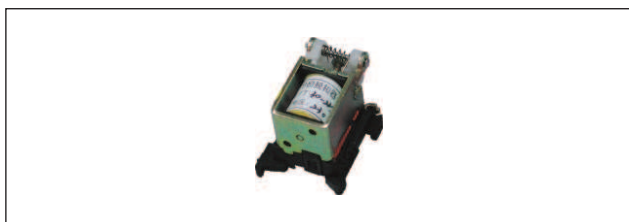

11.3 Contacto auxiliar

Calibre del interruptor	Corriente térmica convencional I_{th} (A)	Corriente nominal I_e (A) a 400 Vca	Corriente nominal I_e (A) a 230 Vcc
$I_{nm} \leq 225A$	3	0.26	0.14
$I_{nm} \geq 400A$	6	3	0.2

a. Contacto auxiliar



b. Contacto de alarma

Cuando el interruptor conecta y corta, el contacto de alarma no funciona. Tras la activación del contacto de alarma debido a un disparo libre (o disparo por fallo), y después de que el interruptor vuelva a funcionar, el contacto de alarma volverá a su estado original.

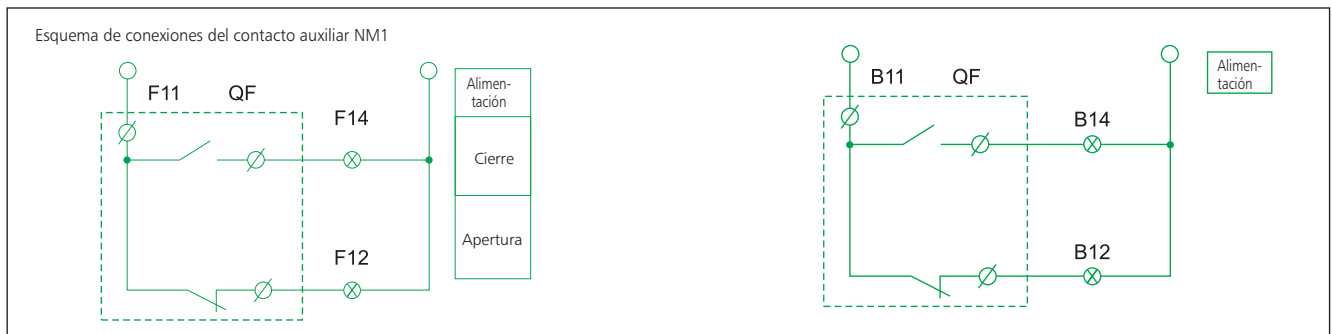
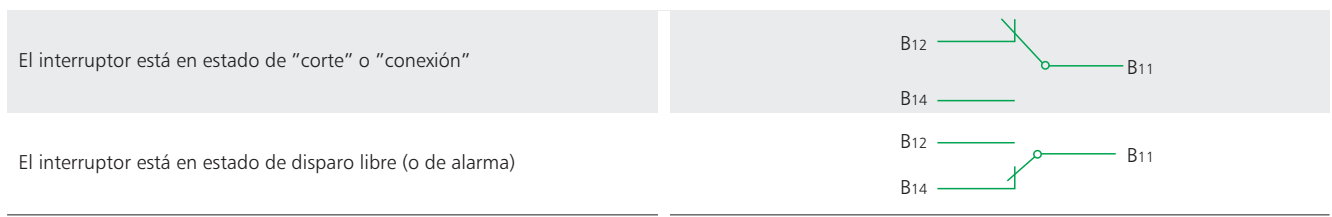

Accesorios externos

11.4 Accionamiento motorizado

Características	Modelo	NM1-63 NM1-125, NM1-250, NM1-400, NM1-630, NM1-800, NM1-1250
Estructura	Sistema electromagnético	Motor
Códigos de CA/CC	A1/D1, A2/D2, A4, D3	

Nota: A1=110Vca, A2=230Vca, A4=400Vca, D1=110Vcc, D2=220Vcc, D3=24Vcc

Esquema de cierre y apertura del mecanismo de accionamiento motorizado (CA) de NM1-400, 630, 800, 1250

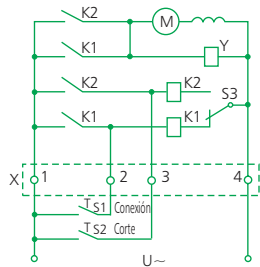

Con relé de cierre automático

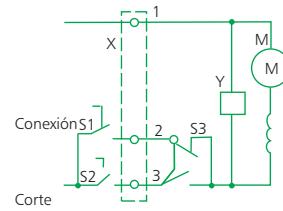

Sin relé de cierre automático

Características: 50Hz 230Vca y 400Vca

Mando manual rotativo

Gráfico de montaje del mando manual rotativo

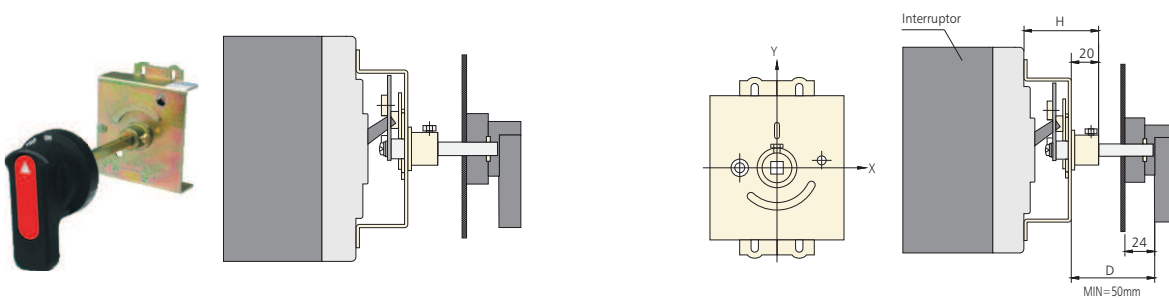

Dimensiones

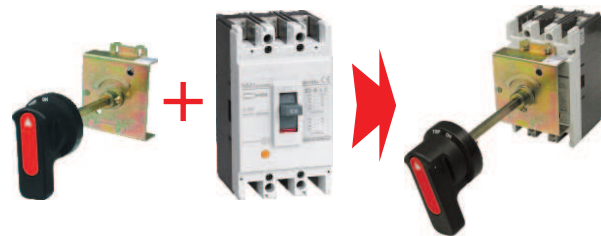
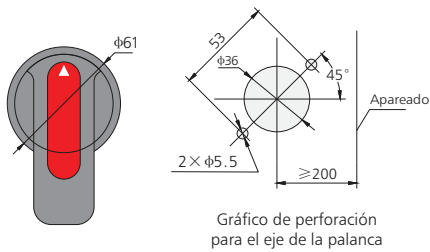

(mm)

Modelo	NM1-63	NM1-125	NM1-250	NM1-400	NM1-630	NM1-800H NM1-800R
Tamaño de montaje	49	51	54	88	89	76
El valor Y de la palanca hace referencia al centro del interruptor	0	0	0	0	0	0

Dimensiones de montaje y perforación

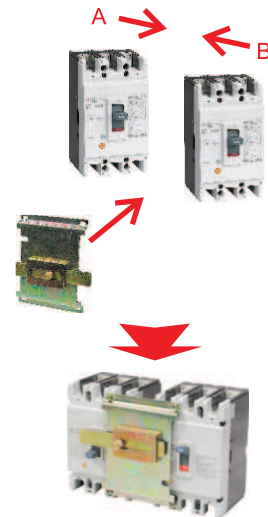
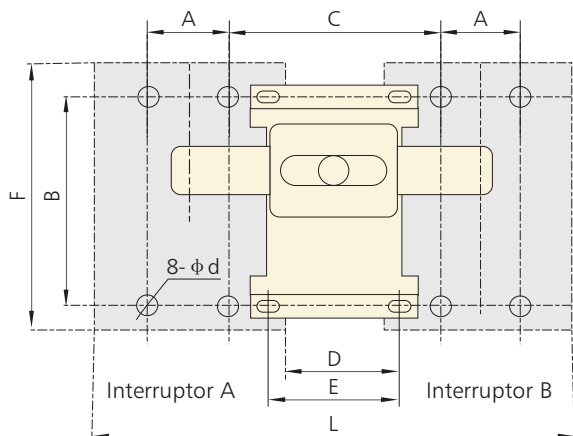

(mm)

Modelo	A	B	C	D	E	F	L	Φd
NM1-63	25	117	80	30	80	135	182	4.5
NM1-100	30	130.5	90	30	90	155	210	4.5×6*
NM1-225	35	126	100	30	100	165	240	5.5
NM1-400	44	194	136	30	40	257	330	7
NM1-630	58	200	172	48	62	270	412	7
NM1-800	70	243	167	28	40	280	448	7

Nota:

- * representa la dimensión de perforación.
- Instalar el interruptor sobre el marco y a continuación el bloqueo mecánico sobre el interruptor.

12. Información técnica adicional

- 12.1 Bajo consulta a Chint, dependiendo de las características de servicio de los NM1-225, es posible aumentar su corriente nominal hasta 250A.
- 12.2 Los interruptores NM1-1250 se suministran de serie con pletinas de conexión. Si se requieren pletinas de conexión para otros calibres de interruptores NM1 éstas deberán solicitarse aparte.
- 12.3 Sólo los interruptores de la serie NM1-H son aptos para ser usados como seccionador.
- 12.4 Existen cubrebornes para todos los modelos de la serie NM1. Con ellos los aparatos pueden alcanzar un grado de protección IP40 si están correctamente montados.

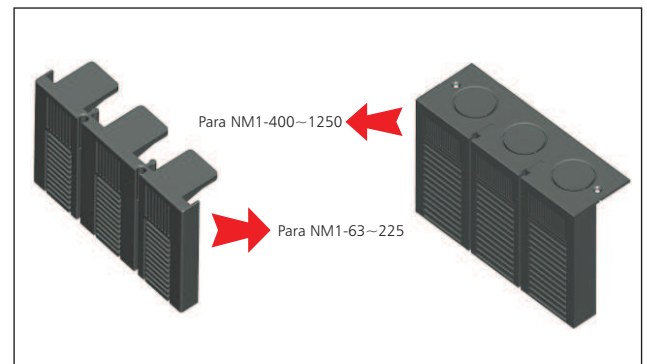

12.5 Distancia de seguridad entre dispositivos eléctricos a tener en cuenta en el montaje

(mm)

Distancias mínimas / Modelo	NM1-63	NM1-100	NM1-225	NM1-400	NM1-630	NM1-800	NM1-1250
Lado de línea	50	50	50	100	100	100	100
Lado de carga	20	20	20	20	20	20	20
Lado derecho	25	25	25	25	25	25	25
Lado izquierdo	25	25	25	25	25	25	25

12.6 Tabla de pares de apriete

Calibre del cable (cobre)		Corriente nominal (A)	Par de apriete (N · m)	
AWG/MCM	mm ²		Pletina frontal	Terminal
16-6	1.5-16	10 ≤ In ≤ 63	5	3
4-3	25-35	63 < In ≤ 100	10	8
2-4/0	50-95	100 < In ≤ 225	14	10
300-500	120-240	225 < In ≤ 400	18	16
250×2	150×2	400 < In ≤ 500	22	18
350×2	185×2	500 < In ≤ 630	26	20
500×2	240×2	630 < In ≤ 800	28	-
350×4	185×4	800 < In ≤ 1250	30	-

12.7 Datos técnicos de la serie NM1

Corriente base (A)	Modelo	Número de polos	Ui (V)	Icu/Ics(kA)				
				220V 240V	380V 415V	440V	480V 500V	660V 690V
63	NM1-63S	2	500	20/10	15/7.5	-	-	-
		3	500	20/10	15/7.5	10/5	-	-
	NM1-63H	3/4	500	42/21	35/17.5	20/10	-	-
125	NM1-125C	2	800	25/12.5	20/10	-	-	-
		3/4	800	25/12.5	20/10	15/7.5	10/5	3/1.5
	NM1-125S	2	800	42/21	25/12.5	-	-	-
		3/4	800	42/21	25/12.5	20/10	10/5	3/1.5
	NM1-125H	2	800	65/32.5	50/25	-	-	-
		3/4	800	65/32.5	50/25	42/21	25/12.5	8/4
NM1-125R	2	800	85/42.5	65/32.5	-	-	-	
	3/4	800	85/42.5	65/32.5	55/27.5	35/17.5	10/5	
250	NM1-250C	2	800	25/12.5	20/10	-	-	-
		3/4	800	25/12.5	20/10	15/7.5	10/5	5/2.5
	NM1-250S	1	800	20/10	-	-	-	-
		2	800	42/21	25/12.5	-	-	-
	3/4	800	42/21	25/12.5	20/10	10/5	5/2.5	
		NM1-250H	2	800	65/32.5	50/25	-	-
3/4	800		65/32.5	50/25	42/21	25/12.5	8/4	
NM1-250R	2	800	85/42.5	65/32.5	-	-	-	
	3/4	800	85/42.5	65/32.5	55/27.5	35/17.5	10/5	
400	NM1-400S	3/4	800	50/25	35/17.5	30/15	15/7.5	10/5
		3/4	800	85/42.5	50/25	42/21	25/12.5	12/6
	NM1-400R	3/4	800	100/50	70/35	65/32.5	42/21	15/7.5
630	NM1-630S	3/4	800	50/25	35/17.5	30/15	15/7.5	12/6
		3/4	800	85/42.5	50/25	42/21	25/12.5	15/7.5
	NM1-630R	3/4	800	100/50	70/35	65/32.5	40/20	20/10
800	NM1-800H	3/4	800	85/42.5	60/30	55/27.5	30/15	20/10
		3/4	800	100/50	70/35	65/32.5	40/20	20/10
1250	NM1-1250H	3	800	85/42.5	65/32.5	55/27.5	30/15	20/10

Corriente base (A)	Modelo	Número de polos	Ui (V)	Icu/Icm(kA)				
				220V 240V	380V 415V	440V	480V 500V	660V 690V
63	NM1-63S	2	500	20/40	15/30	-	-	-
		3	500	20/40	15/30	10/17	-	-
	NM1-63H	3/4	500	42/88.2	35/73.5	20/40	-	-
125	NM1-125C	2	800	25/52.5	20/40	-	-	-
		3/4	800	25/52.5	20/40	15/30	-	-
	NM1-125S	2	800	42/88.2	25/52.5	-	-	-
		3/4	800	42/88.2	25/52.5	20/40	-	-
	NM1-125H	2	800	65/43	50/105	-	-	-
		3/4	800	65/43	50/105	42/88.2	-	-
NM1-125R	2	800	85/187	65/143	-	-	-	
	3/4	800	85/187	65/143	55/121	-	-	
250	NM1-250C	2	800	25/52.5	20/40	-	-	-
		3/4	800	25/52.5	20/40	15/30	-	-
	NM1-250S	1	800	20/40	-	-	-	-
		2	800	42/88.2	25/52.5	-	-	-
	3/4	800	42/88.2	25/52.5	20/40	-	-	
		NM1-250H	2	800	65/43	50/105	-	-
	3/4		800	65/43	50/105	42/88.2	-	-
	NM1-250R	2	800	85/187	65/143	-	-	-
3/4		800	85/187	65/143	55/121	-	-	
400	NM1-400S	3/4	800	50/105	35/73.5	30/63	-	-
		3/4	800	85/187	50/105	42/88.2	-	-
	NM1-400R	3/4	800	100/220	70/154	65/143	-	-
630	NM1-630S	3/4	800	50/105	35/73.5	30/63	-	-
		3/4	800	85/187	50/105	42/88.2	-	-
	NM1-630R	3/4	800	100/220	70/154	65/43	-	-
800	NM1-800H	3/4	800	85/187	60/132	55/121	-	-
		3/4	800	100/220	70/154	65/143	-	-
1250	NM1-1250H	3	800	85/187	65/143	55/121	-	-

Nota: Los parámetros en negro son sólo orientativos

12.8 Protección en cascada
12.8.1 Tensiones: 220/230/240V

Aguas arriba: NM1-63~1250

Aguas abajo: eB, UB, DZ158, DZ267, NB1, NBH8, NM1-63~1250

Aguas arriba Poder de corte (kA RMS)	NM1-63S 20	NM1-63H 42	NM1-125S 25	NM1-125H 50	NM1-125R 65	NM1-250S 25	NM1-250H 50	
Aguas abajo ↓	Poder de corte (kA RMS)							
DZ267	20	40	20	35	50	20	25	
eB, UB	20	40	20	35	50	20	25	
NBH8	20	40	20	35	50	20	25	
NB1(Icn=6000A)	20	42	25	35	50	25	35	
NB1(Icn=10000A)	20	42	25	40	50	25	35	
DZ158			25	40	50	25	40	
NM1-63S		42	25	50	65	25	50	
NM1-63H					65			
NM1-125S				50	65		50	
NM1-125H					65			
NM1-250S							50	
NM1-250H								
NM1-400S								
NM1-400H								
NM1-630S								
NM1-630H								
NM1-800H								
NM1-1250H								DZ47, eB, UB, DZ158, DZ267, NB1, NBH8, NM1-63~1250

12.8.2 Tensiones: 380/400/415V

Aguas arriba: NM1-63~1250

Aguas abajo: eB, UB, DZ158, DZ267, NB1, NBH8, NM1-63~1250

Aguas arriba Poder de corte (kA RMS)	NM1-63S 15	NM1-63H 35	NM1-125S 25	NM1-125H 50	NM1-125R 65	NM1-250S 25	NM1-250H 50	
Aguas abajo ↓	Poder de corte (kA RMS)							
eB, UB	10	15	10	15	15	10	15	
NB1(Icn=6000A)	15	20	15	20	20	15	20	
NB1(Icn=10000A)	15	20	20	25	25	20	25	
DZ158			20	25	35	20	25	
NM1-63S		35	25	50	65	25	50	
NM1-63H					65			
NM1-125S				50	65		50	
NM1-125H					65			
NM1-250S							50	
NM1-250H								
NM1-400S								
NM1-400H								
NM1-630S								
NM1-630H								
NM1-800H								
NM1-1250H								

NM1-250R 65	NM1-400S 35	NM1-400H 50	NM1-400R 70	NM1-630S 35	NM1-630H 50	NM1-630R 70	NM1-800H 60	NM1-800R 70	NM1-1250H 65
30									
30									
30									
35									
40									
50	30	40	50						
65									
65									
65		50	70		50	70	60	70	65
65			70			70		70	
65		50	70		50	70	60	70	65
65			70			70		70	
		50	70		50	70	60	70	65
			70			70		70	
					50	70			
						70			
								70	

NM1-250R 65	NM1-400S 35	NM1-400H 50	NM1-400R 70	NM1-630S 35	NM1-630H 50	NM1-630R 70	NM1-800H 60	NM1-800R 70	NM1-1250H 65
15									
20									
25									
35	20	25	35						
65									
65									
65		50	70		50	70	60	70	65
65			70			70		70	
65		50	70		50	70	60	70	65
65			70			70		70	
		50	70		50	70	60	70	65
			70			70		70	
					50	70			
						70			
								70	

Códigos

Interruptor en Caja moldeada NM8, NM8S	Página 86
Accesorios para NM8, NM8S	Página 92
Interruptor en Caja moldeada NM1	Página 96
Accesorios para NM1	Página 99

NM8, NM8S

→ Tipo S

P=Distribución de potencia; M=Protección de motor

Nota:

- a. Productos marcados con * : Confirmar disponibilidad. Productos en desarrollo
- b. Los productos marcados con — no se encuentran en desarrollo actualmente.

★ NM8-125S, modelo magnetotérmico, Icu=50kA

Corriente nominal (A)	3P		Embalaje	4P		Embalaje
	P	M		P	M	
16	123001	123011	8	123021	123031*	8
20	123002	123012	8	123022	123032*	8
25	123003	123013	8	123023	123033*	8
32	123004	123014	8	123024	123034*	8
40	123005	123015	8	123025	123035*	8
50	123006	123016	8	123026	123036*	8
63	123007	123017	8	123027	123037*	8
80	123008	123018	8	123028	123038*	8
100	123009	123019	8	123029	123039*	8
125	123010	123020	8	123030	123040*	8

★ NM8S-125S, modelo electrónico, Icu=50kA

Corriente nominal (A)	3P		Embalaje	4P		Embalaje
	P	M		P	M	
40	123041	123044	8	123047	123050*	8
100	123042	123045	8	123048	123051*	8
125	123043	123046	8	123049	123052*	8

★ NM8-250S, modelo magnetotérmico, Icu=50kA

Corriente nominal (A)	3P		Embalaje	4P		Embalaje
	P	M		P	M	
100	123053	123057	8	123061	123065*	8
160	123054	123058	8	123062	123066*	8
200	123055	123059	8	123063	123067*	8
250	123056	123060	8	123064	123068*	8

★ NM8S-250S, modelo electrónico, Icu=50kA

Corriente nominal (A)	3P		Embalaje	4P		Embalaje
	P	M		P	M	
100	123069	123073	8	123077	123081*	8
160	123070	123074	8	123078	123082*	8
200	123071	123075	8	123079	123083*	8
250	123072	123076	8	123080	123084*	8

★ NM8-400S, modelo magnetotérmico, Icu=70kA

Corriente nominal (A)	3P		Embalaje	4P		Embalaje
	P	M		P	M	
250	123085	123089	2	123093*	123097*	
315	123086	123090	2	123094*	123098*	
350	123087	123091	2	123095*	123099*	
400	123088	123092	2	123096*	123100*	

★ NM8S-400S, modelo electrónico, Icu=70kA

Corriente nominal (A)	3P		Embalaje	4P		Embalaje
	P	M		P	M	
250	123101	123105	2	123109	123113*	2
315	123102	123106	2	123110	123114*	2
350	123103	123107	2	123111	123115*	2
400	123104	123108	2	123112	123116*	2

★ NM8-630S, modelo magnetotérmico, Icu=70kA

Corriente nominal (A)	3P		Embalaje	4P		Embalaje
	P	M		P	M	
250	123117	123122	2	123127*	123132*	
315	123118	123123	2	123128*	123133*	
350	123119	123124	2	123129*	123134*	
400	123120	123125	2	123130*	123135*	
500	123121	123126	2	123131*	123136*	

★ NM8S-630S, modelo electrónico, Icu=70kA

Corriente nominal (A)	3P		Embalaje	4P		Embalaje
	P	M		P	M	
250	123137	123143	2	123149*	123155*	—
315	123138	123144	2	123150*	123156*	—
350	123139	123145	2	123151*	123157*	2
400	123140	123146	2	123152	123158*	2
500	123141	123147	2	123153	123159*	2
630	123142	123148	2	123154	123160*	2

★ NM8-800S, modelo magnetotérmico, Icu=50kA

Corriente nominal (A)	3P		Embalaje	4P		Embalaje
	P	M		P	M	
630	123161	—	1	123164*	—	
700	123162	—	1	123165*	—	
800	123163	—	1	123166*	—	

★ NM8S-800S, modelo electrónico, Icu=50kA

Corriente nominal (A)	3P		Embalaje	4P		Embalaje
	P	M		P	M	
630	123167	—	1	123170*	—	
700	123168	—	1	123171*	—	
800	123169	—	1	123172*	—	

★ NM8-1250S, modelo magnetotérmico, Icu=50kA

Corriente nominal (A)	3P		Embalaje	4P		Embalaje
	P	M		P	M	
630	123161	—	1	123176*	—	
700	123162	—	1	123177*	—	
800	123173	—	1	123178*	—	
1000	123174	—	1	123179*	—	
1250	123175	—	1	123180*	—	

★ NM8S-1250S, modelo electrónico, Icu=50kA

Corriente nominal (A)	3P		Embalaje	4P		Embalaje
	P	M		P	M	
630	123167	—	1	123184*	—	
700	123168	—	1	123185*	—	
800	123181	—	1	123186*	—	
1000	123182	—	1	123187*	—	
1250	123183	—	1	123188*	—	

➔ Tipo H

★ NM8-125H, modelo magnetotérmico, Icu=100kA

Corriente nominal (A)	2P		Embalaje	3P		Embalaje	4P		Embalaje
	P	M		P	M		P	M	
16	123189	123199	16	123209	123219	8	123229	123239	8
20	123190	123200	16	123210	123220	8	123230	123240	8
25	123191	123201	16	123211	123221	8	123231	123241	8
32	123192	123202	16	123212	123222	8	123232	123242	8
40	123193	123203	16	123213	123223	8	123233	123243	8
50	123194	123204	16	123214	123224	8	123234	123244	8
63	123195	123205	16	123215	123225	8	123235	123245	8
80	123196	123206	16	123216	123226	8	123236	123246	8
100	123197	123207	16	123217	123227	8	123237	123247	8
125	123198	123208	16	123218	123228	8	123238	123248	8

★ NM8S-125H, modelo electrónico, Icu=70kA

Corriente nominal (A)	3P		Embalaje	4P		Embalaje
	P	M		P	M	
40	123249	123252	8	123255	123258	8
100	123250	123253	8	123256	123259	8
125	123251	123254	8	123257	123260	8

★ NM8-250H, modelo magnetotérmico, Icu=100kA

Corriente nominal (A)	3P		Embalaje	4P		Embalaje
	P	M		P	M	
100	123269	123273	8	123277	123281	8
160	123270	123274	8	123278	123282	8
200	123271	123275	8	123279	123283	8
250	123272	123276	8	123280	123284	8

★ NM8S-250H, modelo electrónico, Icu=70kA

Corriente nominal (A)	3P		Embalaje	4P		Embalaje
	P	M		P	M	
100	123285	123289	8	123293	123297	8
160	123286	123290	8	123294	123298	8
200	123287	123291	8	123295	123299	8
250	123288	123292	8	123296	123300	8

★ NM8-400H, modelo magnetotérmico, Icu=100kA

Corriente nominal (A)	3P		Embalaje	4P		Embalaje
	P	M		P	M	
250	123301	123305	2	123309	123313	2
315	123302	123306	2	123310	123314	2
350	123303	123307	2	123311	123315	2
400	123304	123308	2	123312	123316	2

★ NM8S-400H, modelo electrónico, Icu=100kA

Corriente nominal (A)	3P		Embalaje	4P		Embalaje
	P	M		P	M	
250	123317	123321	2	123325	123329	2
315	123318	123322	2	123326	123330	2
350	123319	123323	2	123327	123331	2
400	123320	123324	2	123328	123332	2

★ NM8-630H, modelo magnetotérmico, Icu=100kA

Corriente nominal (A)	3P		Embalaje	4P		Embalaje
	P	M		P	M	
250	123333	123338	2	123343	123348	2
315	123334	123339	2	123344	123349	2
350	123335	123340	2	123345	123350	2
400	123336	123341	2	123346	123351	2
500	123337	123342	2	123347	123352	2

★ NM8S-630H, modelo electrónico, Icu=100kA

Corriente nominal (A)	3P		Embalaje	4P		Embalaje
	P	M		P	M	
250	123353	123359	2	123365	123371	2
315	123354	123360	2	123366	123372	2
350	123355	123361	2	123367	123373	2
400	123356	123362	2	123368	123374	2
500	123357	123363	2	123369	123375	2
630	123358	123364	2	123370	123376	2

★ NM8-800H, modelo magnetotérmico, Icu=70kA

Corriente nominal (A)	3P		Embalaje	4P		Embalaje
	P	M		P	M	
630	123377	—		123380*	—	
700	123378	—		123381*	—	
800	123379	—		123382*	—	

★ NM8S-800H, modelo electrónico, Icu=70kA

Corriente nominal (A)	3P		Embalaje	4P		Embalaje
	P	M		P	M	
630	123383	—	1	123386*	—	
700	123384	—	1	123387*	—	
800	123385	—	1	123388*	—	

★ NM8-1250H, modelo magnetotérmico, Icu=70kA

Corriente nominal (A)	3P		Embalaje	4P		Embalaje
	P	M		P	M	
630	123377	—	1	123380	—	1
700	123378	—	1	123381	—	1
800	123389	—	1	123392*	—	
1000	123390	—	1	123393*	—	
1250	123391	—	1	123394*	—	

★ NM8S-1250H, modelo electrónico, Icu=70kA

Corriente nominal (A)	3P		Embalaje	4P		Embalaje
	P	M		P	M	
630	123383	—	1	123386	—	1
700	123384	—	1	123387	—	1
800	123395	—	1	123398*	—	
1000	123396	—	1	123399*	—	
1250	123397	—	1	123400*	—	

➔ Tipo R

★ NM8-125R, modelo magnetotérmico, Icu=125kA

Corriente nominal (A)	3P		Embalaje
	P	M	
16	123401	123411	8
20	123402	123412	8
25	123403	123413	8
32	123404	123414	8
40	123405	123415	8
50	123406	123416	8
63	123407	123417	8
80	123408	123418	8
100	123409	123419	8
125	123410	123420	8

★ NM8S-125R, modelo electrónico, Icu=100kA

Corriente nominal (A)	3P		Embalaje
	P	M	
40	123421	123424	8
100	123422	123425	8
125	123423	123426	8

★ NM8-250R, modelo magnetotérmico, Icu=125kA

Corriente nominal (A)	3P		Embalaje
	P	M	
100	123427	123431	8
160	123428	123432	8
200	123429	123433	8
250	123430	123434	8

★ NM8S-250R, modelo electrónico, Icu=100kA

Corriente nominal (A)	3P		Embalaje
	P	M	
100	123435	123439	8
160	123436	123440	8
200	123437	123441	8
250	123438	123442	8

★ NM8-400R, modelo magnetotérmico, Icu=125kA

Corriente nominal (A)	3P		Embalaje
	P	M	
250	123443	123447	2
315	123444	123448	2
350	123445	123449	2
400	123446	123450	2

★ NM8S-400R, modelo electrónico, Icu=125kA

Corriente nominal (A)	3P		Embalaje
	P	M	
250	123451	123455	2
315	123452	123456	2
350	123453	123457	2
400	123454	123458	2

★ NM8-630R, modelo magnetotérmico, Icu=125kA



Corriente nominal (A)	3P		Embalaje
	P	M	
250	123459	123464	2
315	123460	123465	2
350	123461	123466	2
400	123462	123467	2
500	123463	123468	2

★ NM8S-630R, modelo electrónico, Icu=125kA

Corriente nominal (A)	3P		Embalaje
	P	M	
250	123469	123475	2
315	123470	123476	2
350	123471	123477	2
400	123472	123478	2
500	123473	123479	2
630	123474	123480	2

Accesorios

Accesorios	Para interruptores	2P	3P	4P
		Código	Código	Código
 Pletinas frontales	NM8-125	125601	125603	125608
	NM8-250/NM8S-125/NM8S-250	125602	125604	125609
	NM8-400,630/NM8S-400,630	—	125605	125610
	NM8-800, 1250/NM8S-800, 1250	—	125606	125611
 Conexión posterior	NM8-125	125613	125615	125618
	NM8-250/NM8S-125/NM8S-250	125614*	125616	125619
	NM8-400,630/NM8S-400,630	—	125617	125620
 Base enchufable	NM8-125	—	125621	125624
	NM8-250/NM8S-125/NM8S-250	—	125622	125625
	NM8-400, 630/NM8S-400, 630	—	125623	125626
 Adaptador a carril DIN	NM8-125	—	125627	125629
	NM8-250/NM8S-125/NM8S-250	—	125628	125630
 Mando rotativo con eje prolongado	NM8-125	—	125655	125719
	NM8-250/NM8S-125/NM8S-250	—	125656	125720
	NM8-400, 630/NM8S-400, 630	—	125657	125721
	NM8(S)-1250	—	125658	125658
 Mando rotativo directo	NM8-125	—	125659	125659
	NM8-250	—	125660	125660
	NM8S-125/NM8S-250	—	125722	125722
	NM8-400, 630	—	125661	125661
	NM8S-400, 630	—	125723	125723
 Mando rotativo con eje prolongado	NM8-125	—	125662	125662
	NM8-250	—	125663	125663
	NM8S-125/NM8S-250	—	125724	125724
	NM8-400, 630	—	125664	125664
	NM8S-400, 630	—	125725	125725

Accesorios	Para interruptores	2P	3P	4P
		Código	Código	Código
 Cubrebornes largo	NM8-125	—	125674	125678
	NM8-250/NM8S-125/NM8S-250	—	125675	125679
	NM8-400, 630/NM8S-400, 630	—	125676	125680
	NM8(S)-800,1250	—	125677	125726
 Cubrebornes corto	NM8-125	—	125681	125685
	NM8-250/NM8S-125/NM8S-250	—	125682	125686
	NM8-400, 630/NM8S-400, 630	—	125683	125687
	NM8(S)-800,1250	—	125684	125727

Accesorios	Para interruptores	Código
 Bloqueo por candado	NM8-125	125671
	NM8-250/NM8S-125/NM8S-250	125672
	NM8-400, 630/NM8S-400, 630	125673
	NM8-800,1250/NM8S-800,1250	125731

Accesorios	Para interruptores	240Vca/220Vcc
		Código
	NM8-125	125688
	NM8-250/NM8S-125,250	125689
	Para interruptores	230Vca/220Vcc
	Código	125690
	NM8-400,630/NM8S-400,630	125690
	Para interruptores	230Vca/400Vcc
Código	125691	
NM8-800, 1250/NM8S-800, 1250	125691	

Accesorios	Para interruptores	220Vca	380Vca	24Vcc	110Vcc
		Código	Código	Código	Código
 Bobina de emisión	NM8-125	125692	125695	125698*	—
	NM8-250/NM8S-125/NM8S-250/ NM8-400,630/NM8S-400,630	125693	125696	125699*	—
	NM8-800, 1250/NM8S-800, 1250	125694	125697	125700*	125701*
 Bobina de mínima	NM8-125	125702	125705	—	—
	NM8-250/NM8S-125/NM8S-250/ NM8-400,630/NM8S-400,630	125703	125706	—	—
	NM8-800, 1250/NM8S-800, 1250	125704	125707	—	—

Accesorios	Para interruptores	Código
 Contacto auxiliar (Izquierdo)	Todos	125708
 Contacto auxiliar (central)	Todos	125739
 Contacto auxiliar (derecho)	Todos	125740
 Contacto de alarma	Todos	125709

Accesorios	Para interruptores	3P	4P
		Código	Código
 Bloqueo mecánico	NM8-125	125710	125713
	NM8-250/NM8S-250,125	125711	125714
	NM8-400,630/NM8S-400,630	125712*	125715*

Accesorios	Para interruptores	3P
		Código
 Bloqueo mecánico	NM8-125	125716
	NM8-250/NM8S-250,125	125717
	NM8-400,630/NM8S-400,630	125718

Accesorios	Para	Características	Order code	Par de apriete (N.m)	Sección(mm ²) cobre
Terminal					
	NM8-125	Interno (Una conexión)	125728	8	4~95
		Externo (Una conexión)	125631	10	16~95
	NM8-250	Interno (Una conexión)	125729	25	10~120
		Externo (Una conexión)	125632	30	35~120
		Externo (Conexión doble)	125633	30	2×(35~120)
		Externo (Seis conexiones)	125630	10	6×35
	NM8-630	Interno (Una conexión)	125638	35	120~240
		Externo (Conexión doble)	125636	35	2×(120~240)
		Externo (Cuatro conexiones)	125636	20	4×(35~95)
	NM8-1250	Externo (Tres conexiones)	125639	50	3×(185~240)
		Externo (Cuatro conexiones)	125640	50	4×(120~185)

NM1

→ Tipo S

P=Distribución de potencia; M=Protección de motor

★ NM1-63S, modelo magnetotérmico, Icu=15kA

Corriente nominal (A)	3P		Embalaje
	P	M	
10	121001	121009	18
16	121002	121010	18
20	121003	121011	18
25	121004	121012	18
32	121005	121013	18
40	121006	121014	18
50	121007	121015	18
63	121008	121016	18

★ NM1-125S, modelo magnetotérmico, Icu=25kA

Corriente nominal (A)	3P		Embalaje
	P	M	
10	121017	121027	18
16	121018	121028	18
20	121019	121029	18
25	121020	121030	18
32	121021	121031	18
40	121022	121032	18
50	121023	121033	18
63	121024	121034	18
80	121025	121035	18
100	121026	121036	18

★ NM1-250S, modelo magnetotérmico, Icu=25kA

Corriente nominal (A)	3P		Embalaje
	P	M	
100	121037	121043	12
125	121038	121044	12
160	121039	121045	12
180	121040	121046	12
200	121041	121047	12
225	121042	121048	12

★ NM1-400S, modelo magnetotérmico, Icu=35kA

Corriente nominal (A)	3P		Embalaje	4P		Embalaje
	P	M		P	M	
225	121049	121054	4	121059	121064	2
250	121050	121055	4	121060	121065	2
315	121051	121056	4	121061	121066	2
350	121052	121057	4	121062	121067	2
400	121053	121058	4	121063	121068	2

★ NM1-630S, modelo magnetotérmico, Icu=35kA

Corriente nominal (A)	3P		Embalaje	4P		Embalaje
	P	M		P	M	
400	121069	121072	4	121075	121078	2
500	121070	121073	4	121076	121079	2
630	121071	121074	4	121077	121080	2

➔ **Tipo H**

★ NM1-63H, modelo magnetotérmico, Icu=35kA

Corriente nominal (A)	2P		Embalaje	3P		Embalaje	4P		Embal.
	P	M		P	M		P	M	
10	121081*	121089*		121097	121105	18	121113	121121	12
16	121082*	121090*		121098	121106	18	121114	121122	12
20	121083*	121091*		121099	121107	18	121115	121123	12
25	121084*	121092*		121100	121108	18	121116	121124	12
32	121085*	121093*		121101	121109	18	121117	121125	12
40	121086*	121094*		121102	121110	18	121118	121126	12
50	121087*	121095*		121103	121111	18	121119	121127	12
63	121088*	121096*		121104	121112	18	121120	121128	12

★ NM1-125H, modelo magnetotérmico, Icu=50kA

Corriente nominal (A)	2P		Embalaje	3P		Embalaje	4P		Embal.
	P	M		P	M		P	M	
10	121129	121139	24	121149	121159	18	121169	121179	12
16	121130	121140	24	121150	121160	18	121170	121180	12
20	121131	121141	24	121151	121161	18	121171	121181	12
25	121132	121142	24	121152	121162	18	121172	121182	12
32	121133	121143	24	121153	121163	18	121173	121183	12
40	121134	121144	24	121154	121164	18	121174	121184	12
50	121135	121145	24	121155	121165	18	121175	121185	12
63	121136	121146	24	121156	121166	18	121176	121186	12
80	121137	121147	24	121157	121167	18	121177	121187	12
100	121138	121148	24	121158	121168	18	121178	121188	12

★ NM1-250H, modelo magnetotérmico, Icu=50kA

Corriente nominal (A)	2P		Embalaje	3P		Embalaje	4P		Embal.
	P	M		P	M		P	M	
100	121189	121195	16	121201	121207	12	121213	121219	8
125	121190	121196	16	121202	121208	12	121214	121220	8
160	121191	121197	16	121203	121209	12	121215	121221	8
180	121192	121198	16	121204	121210	12	121216	121222	8
200	121193	121199	16	121205	121211	12	121217	121223	8
225	121194	121200	16	121206	121212	12	121218	121224	8

★ NM1-400H, modelo magnetotérmico, Icu=50kA

Corriente nominal (A)	3P		Embalaje
	P	M	
225	121225	121230	4
250	121226	121231	4
315	121227	121232	4
350	121228	121233	4
400	121229	121234	4

★ NM1-630H, modelo magnetotérmico, Icu=50kA

Corriente nominal (A)	3P		Embalaje
	P	M	
400	121235	121238	4
500	121236	121239	4
630	121237	121240	4

★ NM1-800H, modelo magnetotérmico, Icu=60kA

Corriente nominal (A)	3P		Embalaje	4P		Embalaje
	P	M		P	M	
630	121241	121244	4	121247	121250	2
700	121242	121245	4	121248	121251	2
800	121243	121246	4	121249	121252	2

★ NM1-1250H, modelo magnetotérmico, Icu=65kA

Corriente nominal (A)	3P		Embalaje
	P	M	
700	121253	—	1
800	121254	—	1
1000	121255	—	1
1250	121256	—	1

➔ Tipo R

★ NM1-125R, modelo magnetotérmico, Icu=65kA

Corriente nominal (A)	3P		Embalaje
	P	M	
10	121257	121267	18
16	121258	121268	18
20	121259	121269	18
25	121260	121270	18
32	121261	121271	18
40	121262	121272	18
50	121263	121273	18
63	121264	121274	18
80	121265	121275	18
100	121266	121276	18

★ NM1-250R, modelo magnetotérmico, Icu=65kA

Corriente nominal (A)	3P		Embalaje
	P	M	
100	121277	121283	12
125	121278	121284	12
160	121279	121285	12
180	121280	121286	12
200	121281	121287	12
225	121282	121288	12

★ NM1-400R, modelo magnetotérmico, Icu=70kA

Corriente nominal (A)	3P		Embalaje
	P	M	
225	121289	121294	4
250	121290	121295	4
315	121291	121296	4
350	121292	121297	4
400	121293	121298	4

★ NM1-630R, modelo térmico-magnético, Icu=70kA

Corriente nominal (A)	3P		Embalaje
	P	M	
400	121299	121302	4
500	121300	121303	4
630	121301	121304	4

★ NM1-800R, modelo térmico-magnético, Icu=70kA

Corriente nominal (A)	3P		Embalaje
	P	M	
630	121305	121308	4
700	121306	121309	4
800	121307	121310	4

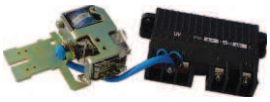
Accesorios	Para interruptores	3P		4P	
		230Vca	400Vca	230Vca	400Vca
 <p>Bobina de mínima</p>	NM1-63S/H	125001	125010	125001	125010
	NM1-100S/H/R	125002	125011	125002	125011
	NM1-225S/H/R	125003	125012	125003	125012
	NM1-400S	125004	125013	125005	125014
	NM1-400H/R	125006	125015	125006	125015
	NM1-630S/H	125007	125016	125007	125016
	NM1-800H/R/630R	125008	125017	125008	125017
	NM1-1250H	125009	125018	125009	125018

Accesorios	Para interruptores	3P		
		230Vca	400Vca	110Vcc
		NM1-63S/H	125019	125028
NM1-100S/H/R	125020	125029	125038	
NM1-225S/H/R	125021	125030	125039	
NM1-400S 3P	125022	125031	125040	
NM1-400H/R	125023	125032	125041	
NM1-630S/H	125024	125033	125042	
NM1-630R	125025	125034	125043	
NM1-800H	125025	125034	125043	
NM1-800R	125025	125034	125043	
NM1-1250H	125027	125036	—	
Bobina de emisión	Para interruptores	4P		
		220Vca	400Vca	
		NM1-63S/H	125019	125028
NM1-100S/H/R	125020	125029		
NM1-225S/H/R	125021	125030		
NM1-400S 3P	125024	125033		
NM1-400H/R	125023	125032		
NM1-630S/H	125024	125033		
NM1-630R	—	—		
NM1-800H	125026	125035		
NM1-800R	—	—		
NM1-1250H	125027	125036		

Accesorios	Para interruptores	3P	4P
		Código	Código
<p>Contacto auxiliar (Izquierdo)</p>	NM1-63S/H	125044	125044
	NM1-100S/H/R	125045	125045
	NM1-225S/H/R	125046	125046
	NM1-400S	125047	125049
	NM1-400H/R	125048	125048
	NM1-630S/H	125049	125049
	NM1-630R	125050	—
	NM1-800H	125050	125051
	NM1-800R	125050	—
	NM1-1250H	125052	125052
<p>Contacto auxiliar (Derecho)</p>	NM1-63S/H	125053	125053
	NM1-100S/H/R	125054	125054
	NM1-225S/H/R	125055	125055
	NM1-400S	125056	125058
	NM1-400H/R	125057	125057
	NM1-630S/H	125058	125058
	NM1-630R	125059	—
	NM1-800H	125059	125060
	NM1-800R	125060	—
	NM1-1250H	125061	125061
<p>Contacto de alarma</p>	NM1-63S/H	125062	125062
	NM1-100S/H/R	125063	125063
	NM1-225S/H/R	125064	125064
	NM1-400S 3P	125065	125067
	NM1-400H/R	125066	125066
	NM1-630S/H	125067	125067
	NM1-630R	125068	—
	NM1-800H	125068	125069
	NM1-800R	125069	—
	NM1-1250H	125070*	125070*

Accesorios	Para interruptores	3P		
		220Vca/cc	220Vca	380Vca
 Accionamiento motorizado	NM1-63S/H	125071	—	—
	NM1-100S	125072	—	—
	NM1-100H/R	125073	—	—
	NM1-225S	125074	—	—
	NM1-225H/R	125075	—	—
	NM1-400S	125076	—	—
	NM1-400H/R	125078	—	—
	NM1-630S/H	125079	—	—
	NM1-800H/R/630R	125080	—	—
	NM1-1250H	—	125081	125082
	Para interruptores	4P		
		220Vca/cc	220Vca	380Vca
	NM1-63S/H	125071	—	—
	NM1-100S	125072	—	—
	NM1-100H/R	125073	—	—
	NM1-225S	125074	—	—
	NM1-225H/R	125075	—	—
NM1-400S	125077	—	—	
NM1-400H/R	125078	—	—	
NM1-630S/H	125079	—	—	
NM1-800H/R/630R	125080	—	—	
NM1-1250H	—	125081	125082	

Accesorios	Para interruptores	3P	4P
		Código	Código
 Mando manual con eje prolongado	NM1-63S/H	125083	125083
	NM1-100S/R	125084	—
	NM1-100H	125084	125085
	NM1-225S/H/R	125086	125086
	NM1-400S	125087	125088
	NM1-400H/R	125089	—
	NM1-630H/R	125090	—
	NM1-630S	125090	125091
	NM1-800H	125092	125093
	NM1-800R	125092	—
	NM1-1250H	125094*	125095*

Accesorios	Para interruptores	3P	4P
		Código	Código
 Base enchufable	NM1-63S	125096	—
	NM1-63H	125096	125097
	NM1-100S/R	125098	—
	NM1-100H	125098	125099
	NM1-225S/R	125100	—
	NM1-225H	125100	125101
	NM1-400S	125102	125104
	NM1-400H/R 3P	125103	—
	NM1-630S	125105	125106
	NM1-630H	125105	—
	NM1-630R	125107	—
	NM1-800H	125107	125108
	NM1-800R	125107	—

Accesorios	Para interruptores	3P	4P
		Código	Código
 Conexión posterior	NM1-63S	125109	—
	NM1-63H	125109	125110
	NM1-100S/R	125111	—
	NM1-100H	125111	125112
	NM1-225S/R 3P	125113	—
	NM1-225H	125113	125114
	NM1-400S/3P	125115	125116
	NM1-400H/R	125115	—
	NM1-630S	125117	125118
	NM1-630H	125117	—
	NM1-630R	125119	—
NM1-800H/R	125119	—	

Accesorios	Para interruptores	3P
		Código
 Bloqueo mecánico	NM1-63S/H	125120
	NM1-100S/H/R	125121
	NM1-225S/H/R	125122
	NM1-400S/H/R	125123
	NM1-630S/H	125124

Accesorios	Para interruptores	3P	4P
		Código	Código
 Terminal de conexión a presión	NM1-100	125125	125131
	NM1-225	125126	125132
	NM1-400	125127	125133
	NM1-630	125128*	125134*
	NM1-800	125129*	125135*
	NM1-1250	125130*	125136*

Accesorios	Para interruptores	3P	4P
		Código	Código
 Pletinas frontales	NM1-63	125137	125143
	NM1-100	125138	125144
	NM1-225	125139	125145
	NM1-400	125140	125146
	NM1-630S/H	125141	125147
	NM1-800/630R	125142	—

Accesorios	Para interruptores	3P	4P
		Código	Código
 <p>Cubrebomes</p>	NM1-63S	125148	125163
	NM1-63H	125149	125164
	NM1-63R	125150	125165
	NM1-100S	125151	125166
	NM1-100H	125152	125167
	NM1-100R	125153	125168
	NM1-225S	125154	125169
	NM1-225H	125155	125170
	NM1-225R	125156	125171
	NM1-400S	125157	125172
	NM1-400H	125158	125173
	NM1-400R	125159	125174
	NM1-630S	125160	125175
	NM1-630H	125161	125176
	NM1-630R	125162	125177
	NM1-800H		125178
	NM1-800R		125179
NM1-1250H		125180	

Modelo								RCC		
			Noruega	Holanda	Rep. Checa	Ucrania	Rusia	Sud Africa	Corea	
NM8 modelo magnetotérmico	2P	125	■	■	■	■	■	—	—	
		250	■	■	■	■	■	—	—	
	3P	125	■	■	■	■	■	—	—	
		250	■	■	■	■	■	—	—	
		400	■	■	—	■	■	—	—	
		630	■	■	■	■	■	—	—	
		800	■	■	—	■	■	—	—	
		1250	■	■	—	■	■	—	—	
	4P	125	■	■	■	■	■	—	—	
		250	■	■	■	■	■	—	—	
		400	■	■	—	■	■	—	—	
		630	■	■	■	■	■	—	—	
		800	■	■	—	■	■	—	—	
		1250	■	■	—	■	■	—	—	
	NM8S modelo electrónico	3P	125	—	—	—	■	■	—	—
			250	—	—	—	■	■	—	—
			400	■	■	—	■	■	—	—
			630	■	■	■	■	■	—	—
			800	—	—	—	■	■	—	—
			1250	—	—	—	■	■	—	—
		4P	125	—	—	—	■	■	—	—
			250	—	—	—	■	■	—	—
			400	■	■	—	■	■	—	—
			630	■	■	■	■	■	—	—
800			—	—	—	■	■	—	—	
1250			—	—	—	■	■	—	—	
NM1	3P	63	—	■	■	■	■	—	■	
		100	—	■	■	■	■	—	■	
		225	—	■	■	■	■	■	■	
		400	—	■	■	■	■	■	—	
		630	—	■	■	■	■	■	—	
		800	—	■	■	■	■	■	—	
		1250	—	■	—	■	■	■	—	
	4P	63	—	■	■	■	■	—	—	
		100	—	■	■	■	■	—	■	
		225	—	■	■	■	■	■	■	
		400	—	■	■	■	■	■	—	
		630	—	■	■	■	■	■	—	
		800	—	—	■	■	■	—	—	
		1250	—	—	—	■	■	—	—	